

Small switching (−20V, −1.5A)

QS5U21

●Features

- 1) The QS5U21 combines Pch MOSFET with a Schottky barrier diode in a single TSMT5 package.
- 2) Pch MOSFET have a low on-state resistance with a fast switching.
- 3) Pch MOSFET is reacted a low voltage drive(2.5V)
- 4) The Independently connected Schottky barrier diode have a low forward voltate.

●Applications

Load switch, DC/DC conversion

●Structure

Silicon P-channel MOSFET
Schottky Barrier DIODE

●Packaging specifications

Type	Package	Taping
	Code	TR
	Basic ordering unit (pieces)	3000
QS5U21		○

●External dimensions (Units : mm)

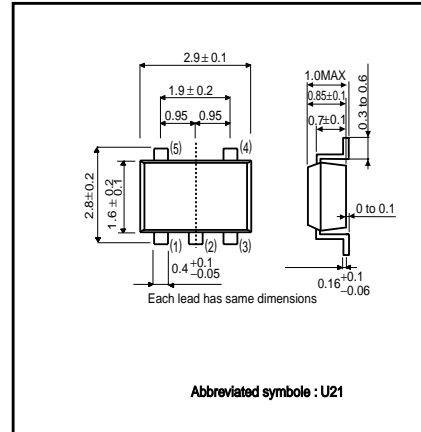

●Equivalent circuit

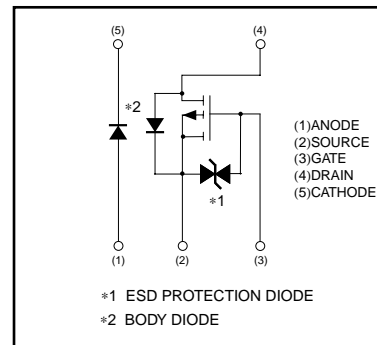

●Absolute maximum ratings (Ta=25°C)

< MOSFET >

Parameter	Symbol	Limits	Unit
DRAIN-SOURCE VOLTAGE	VDSS	-20	V
GATE-SOURCE VOLTAGE	VGSS	±12	V
DRAIN CURRENT	CONTINUOUS	ID	±1.5 A
	PULSED	IDP	±6.0 A PW≤10μs DUTY CYCLE ≤1%
SOURCE CURRENT (BODY DIODE)	CONTINUOUS	IS	-0.75 A
	PULSED	ISP	-0.3 A PW≤10μs DUTY CYCLE ≤1%
CHANNEL TEMPERATURE	Tch	150	°C

< Di >

Parameter	Symbol	Limits	Unit
REPETITIVE PEAK REVERSE VOLTAGE	VRM	25	V
REVERSE VOLTAGE	VR	20	V
FORWARD CURRENT	IF	1.0	A
FORWARD CURRENT SURGE PEAK	IFSM	3.0	A 60HZ / 1CYC.
JUNCTION TEMPERATURE	Tj	125	°C

< MOSFET AND Di >

Parameter	Symbol	Limits	Unit
TOTAL POWER DISSIPATION	PD	1.0	W/TOTAL/MOUNTED ON A CERAMIC BOARD
RANGE OF STRAGE TEMPERATURE	Tstg	-40-125	°C

Transistor

●Electrical characteristics (Ta=25°C)

< MOSFET >

Parameter	Symbol	Min.	Typ.	Max.	Unit	Conditions
Gate-source leakage	I _{GSS}	–	–	±10	μA	V _{GS} =±12V/ V _{DS} =0V
Drain-source breakdown voltage	V _{(BR)DSS}	–20	–	–	V	I _D =–1mA/ V _{GS} =0V
Zero gate voltage drain current	I _{DSS}	–	–	–1	μA	V _{DS} =–20V/ V _{GS} =0V
Gate threshold voltage	V _{GS(th)}	–0.7	–	–2.0	V	V _{DS} =–10V/ I _D =–1mA
Static drain–source on–state resistance	R _{DS(on)} *Pulsed	–	160	200	mΩ	I _D =–1.5A, V _{GS} =–4.5V
		–	180	240	mΩ	I _D =–1.5A, V _{GS} =–4V
		–	260	340	mΩ	I _D =–0.75A, V _{GS} =–2.5V
Forward transfer admittance	Y _{fs} *Pulsed	1.0	–	–	S	V _{DS} =–10V, I _D =–0.75A
Input capacitance	C _{iss}	–	325	–	pF	V _{DS} =–10V
Output capacitance	C _{oss}	–	60	–	pF	V _{GS} =0V
Reverse transfer capacitance	C _{rss}	–	40	–	pF	f=1MHz
Turn–on delay time	t _{d(on)} *Pulsed	–	10	–	ns	I _D =–0.75A
Rise Time	t _r *Pulsed	–	10	–	ns	V _{DD} ≐ –15V
Turn off delay time	t _{d(off)} *Pulsed	–	35	–	ns	V _{GS} =–4.5V R _L =20Ω
Fall time	t _f *Pulsed	–	10	–	ns	R _{GS} =10Ω
Total gate charge	Q _g	–	4.2	–	nC	V _{DD} ≐ –15V
Gate–source charge	Q _{gs}	–	1.0	–	nC	V _{GS} =–4.5V
Gate–drain charge	Q _{gd}	–	1.1	–	nC	I _D =–1.5A

< MOSFET >Body diode(source–drain)

Forward voltage	V _{SD}	–	–	–1.2	V	I _S =–0.75A/ V _{GS} =0V
-----------------	-----------------	---	---	------	---	---

< Di >

Foward voltage drop	V _F	–	–	0.45	V	I _F =1.0A
Reverse leakage	I _R	–	–	200	μA	V _R =20V

Transistor

●Electrical characteristic curves

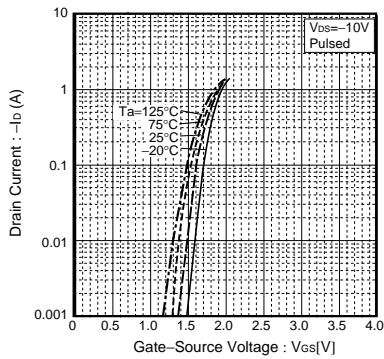

Fig.1 Typical Transfer Characteristics

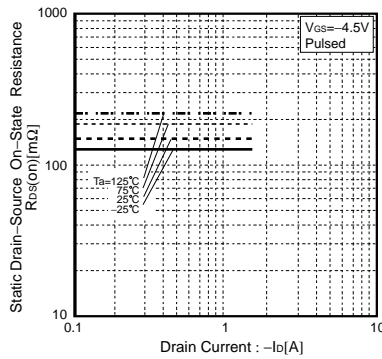

Fig.2 Static Drain-Source On-State Resistance vs. Drain Current

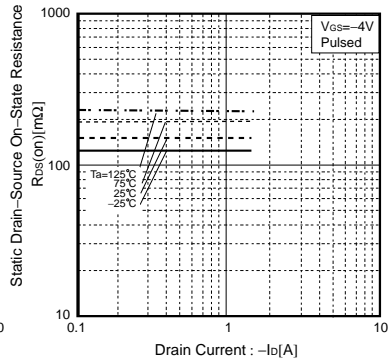

Fig.3 Static Drain-Source On-State Resistance vs. Drain Current

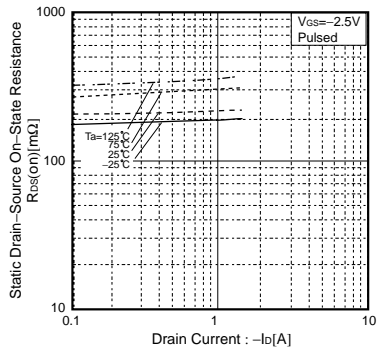

Fig.4 Static Drain-Source On-State Resistance vs. Drain Current

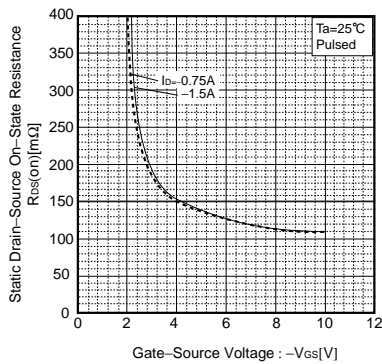

Fig.5 Static Drain-Source On-State Resistance vs. Gate-Source Voltage

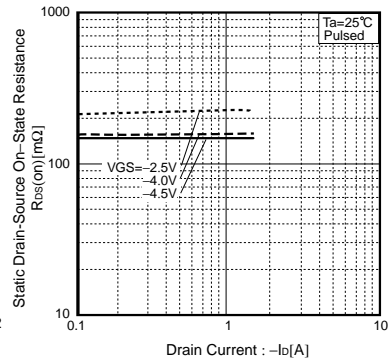

Fig.6 Static Drain-Source On-State Resistance vs. Drain Current

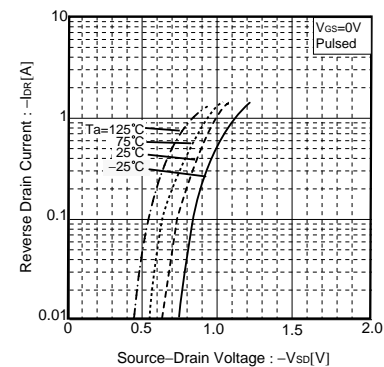

Fig.7 Reverse Drain Current vs. Source-Drain Current

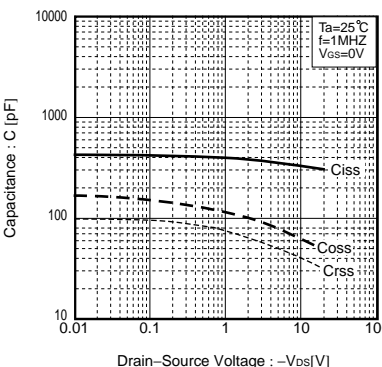

Fig.8 Typical Capacitance vs. Drain-Source Voltage

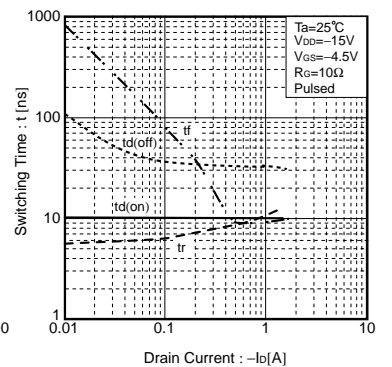

Fig.9 Switching Characteristics

Transistor

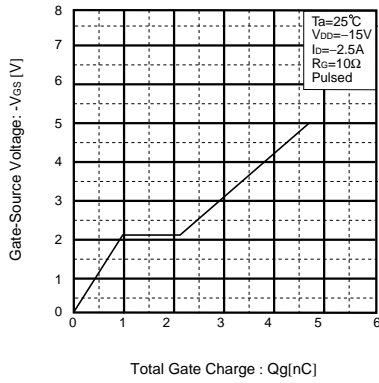

Fig.10 Dynamic Input Characteristics

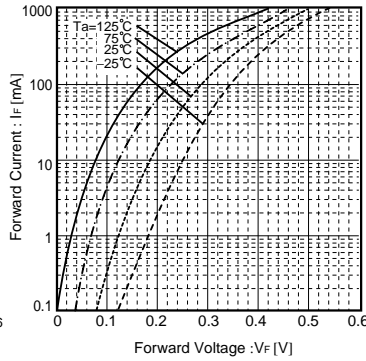

Fig.11 Forward Temperature Characteristics

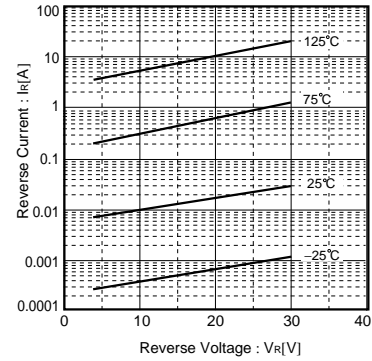

Fig.12 Reverse Temperature Characteristics

● Measurement circuits

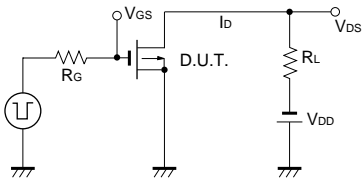

Fig.13 Switching Time Measurement Circuit

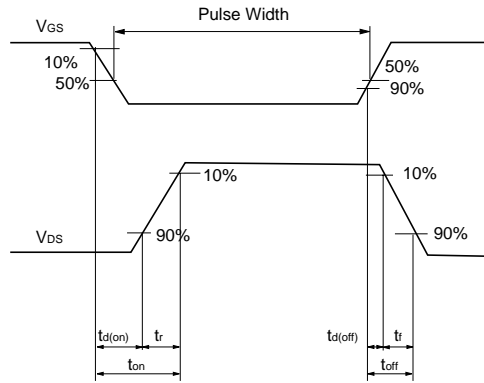

Fig.14 Switching Waveforms

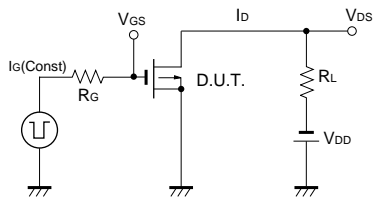

Fig.15 Gate Charge Measurement Circuit

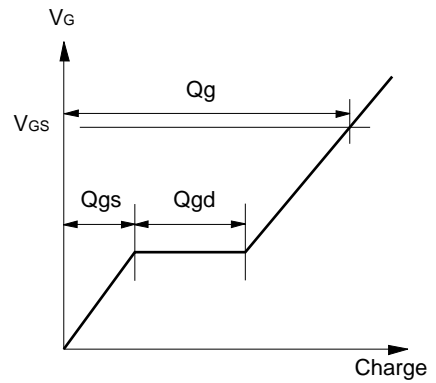

Fig.16 Gate Charge Waveforms