



SPECIFICATIONS

CUSTOMER : **POWERTIP**
SAMPLE CODE (Ver.) : _____
(This Code will be changed while mass production)
MASS PRODUCTION CODE (Ver.) : **PC1602LRS-FWA-H-YW (Ver.0)**

Customer Approved
Date: _____

Sales Sign	QC Confirmed	Checked	Designer
		 12/24	

 Approval For Specifications Only.

* This specification is subject to change without notice.

Please contact Powertip or it's representative before designing your product based on this specification.

 Approval For Specifications and Sample.

Powertip Corporation
Headquarters:

 No.8, 6th Road, Taichung Industrial Park,

Taichung, Taiwan

台中市 407 工業區六路 8 號

TEL: 886-4-2355-8168

FAX: 886-4-2355-8166

 E-mail: sales@powertip.com.tw

 Http://www.powertip.com.tw

RECORDS OF REVISION

Date	Ver	Description	Note	Page
2004/12/08	0	New Sample		

Total : 21Page

Contents

1. SPECIFICATIONS

- 1.1 Features*
- 1.2 Mechanical Specifications*
- 1.3 Absolute Maximum Ratings*
- 1.4 DC Electrical Characteristics*
- 1.5 Optical Characteristics*
- 1.6 Backlight Characteristics*

2. MODULE STRUCTURE

- 2.1 Counter Drawing*
- 2.2 Interface Pin Description*
- 2.3 Timing Characteristics*
- 2.4 Display Command*
- 2.5 Character Pattern*

3. QUALITY ASSURANCE SYSTEM

- 3.1 Quality Assurance Flow Chart*
- 3.2 Inspection Specification*

4. RELIABILITY TEST

- 4.1 Reliability Test Condition*

5. PRECAUTION RELATING PRODUCT HANDLING

- 5.1 Safety*
- 5.2 Handling*
- 5.3 Storage*
- 5.4 Terms of Warranty*

Note : For detailed information please refer to IC data sheet : ST7066U,KS0065B

1. SPECIFICATIONS

1.1 Features

Item	Standard Value
Display Type	16*2 Characters
LCD Type	STN Gray Positive Transflective Extended Temp.
Driver Condition	LCD Module : 1/16 Duty , 1/5Bias
Viewing Direction	6 O'clock
Backlight	YG LED B/L
Weight	39g
Interface	—
Other	—

1.2 Mechanical Specifications

Item	Standard Value	Unit
Outline Dimension	84.0(L) * 44.0(w) * 13.7(H)(Max)	mm
Viewing Area	61.0(L) * 15.8(w)	mm
Active Area	56.21(L) * 11.5(w)	mm
Dot Size	0.56(L) * 0.66(w)	mm
Dot Pitch	0.60 (L) * 0.70(w)	mm

Note : For detailed information please refer to LCM drawing

1.3 Absolute Maximum Ratings

Item	Symbol	Condition	Min.	Max.	Unit
Power Supply Voltage	V _{DD}	—	-0.3	7.0	V
LCD Driver Supply Voltage	V _{LCD}	—	V _{DD} -10.0	V _{DD} +0.3	V
Input Voltage	V _{IN}	—	-0.3	V _{DD} +0.3	V
Operating Temperature	T _{OP}	Excluded B/L	-20	70	°C
Storage Temperature	T _{ST}	Excluded B/L	-30	80	°C
Storage Humidity	H _D	T _a >40 °C	-	95	%RH

1.4 DC Electrical Characteristics

$V_{DD} = 5.0 \pm 0.2V$, $V_{SS} = 0V$, $T_a = 25^\circ C$

Item	Symbol	Condition	Min.	Typ.	Max.	Unit
Logic Supply Voltage	V_{DD}	—	4.8	5.0	5.2	V
“H” Input Voltage	V_{IH}	—	$0.7 V_{DD}$	-	V_{DD}	V
“L” Input Voltage	V_{IL}	—	-0.3	-	0.6	V
“H” Output Voltage	V_{OH}	$I_{OH} = -0.1mA$	3.9	-	V_{DD}	V
“L” Output Voltage	V_{OL}	$I_{OL} = 0.1mA$	-	-	0.4	V
Supply Current	I_{DD}	$V_{DD} = 5.0V$	-	1.3	-	mA
LCM Driver Voltage	V_{OP}					V
		$-20^\circ C \sim 70^\circ C$		Fixed		

1.5 Optical Characteristics

LCD Panel : 1/16 Duty , 1/4 Bias , $V_{LCD} = 4.2V$, $T_a = 25^\circ C$

Item	Symbol	Conditions	Min.	Typ.	Max.	Reference
View Angle	θ	$C \geq 2.0, \varnothing = 0^\circ$	40°	-	-	Notes 1 & 2
Contrast Ratio	C	$\theta = 5^\circ, \varnothing = 0^\circ$	5	7	-	Note 3
Response Time(rise)	t_r	$\theta = 5^\circ, \varnothing = 0^\circ$	-	80 ms	120 ms	Note 4
Response Time(fall)	t_f	$\theta = 5^\circ, \varnothing = 0^\circ$	-	170 ms	255 ms	Note 4

Note 1: Definition of angles θ and \varnothing

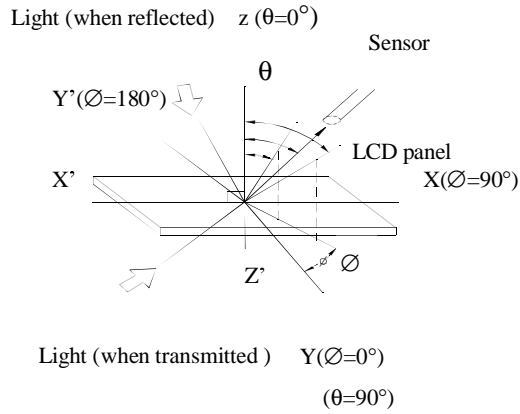

Note 2: Definition of viewing angles θ_1 and θ_2

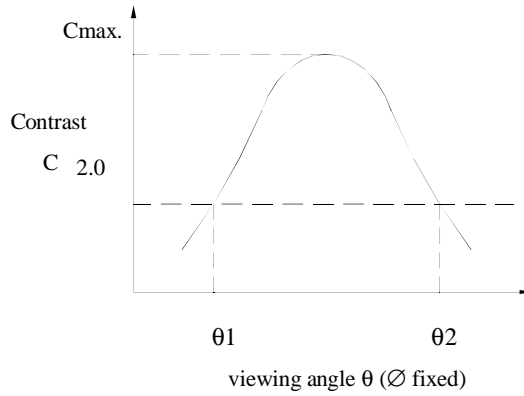

Note : Optimum viewing angle with the naked eye and viewing angle θ at C_{max} . Above are not always the same

Note 3: Definition of contrast C

$$C = \frac{\text{Brightness (reflection) of unselected dot (B2)}}{\text{Brightness (reflection) of selected dot (B1)}}$$

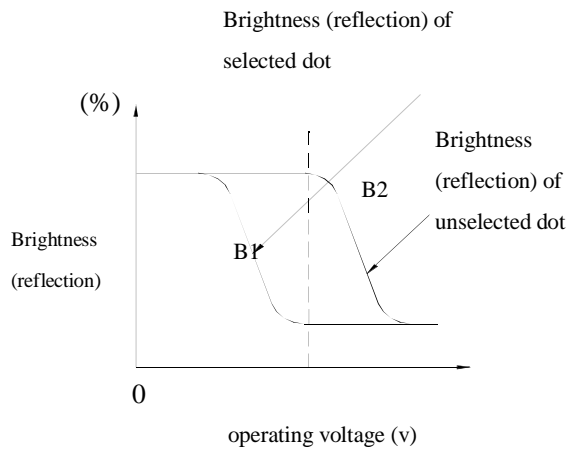

Note 4: Definition of response time

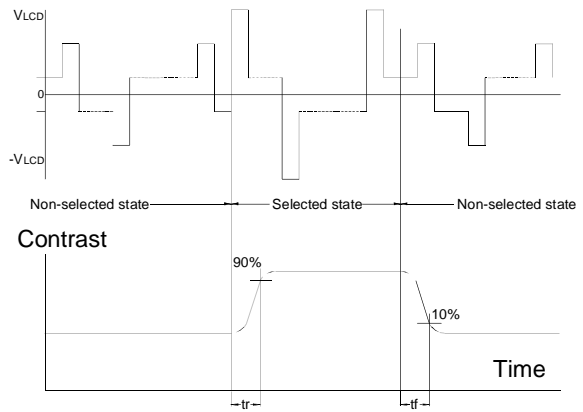

Note: Measured with a transmissive LCD panel which is displayed 1 cm^2

V_{LCD} : Operating voltage f_{FRM} : Frame frequency

t_r : Response time (rise) t_f : Response time (fall)

1.6 Backlight Characteristics

LCD Module with LED Backlight

Maximum Ratings

Item	Symbol	Conditions	Min.	Max.	Unit
Forward Current	IF	Ta =25°C	-	300	mA
Reverse Voltage	VR	Ta =25°C	-	8	V
Power Dissipation	PO	Ta =25°C	-	1.38	W
Operating Temperature	T _{OP}	-	-20	70	°C
Storage Temperature	T _{ST}	-	-40	80	°C
Solder Temp. for 3 Second	-	-	-	260	°C

Electrical / Optical Characteristics

Ta =25°C

Item	Symbol	Conditions	Min.	Typ.	Max.	Unit
Forward Voltage	VF	IF= 120 mA	-	4.2	4.6	V
Reverse Current	IR	VR= 8 V	-	-	0.2	mA
Wavelength	λ p	IF= 120 mA	571	-	576	nm
Luminous Intensity (without LCD)	IV	IF=120 mA	144	180	-	cd/m ²
Color	Yellow-green					

2. MODULE STRUCTURE

2.1 Counter Drawing

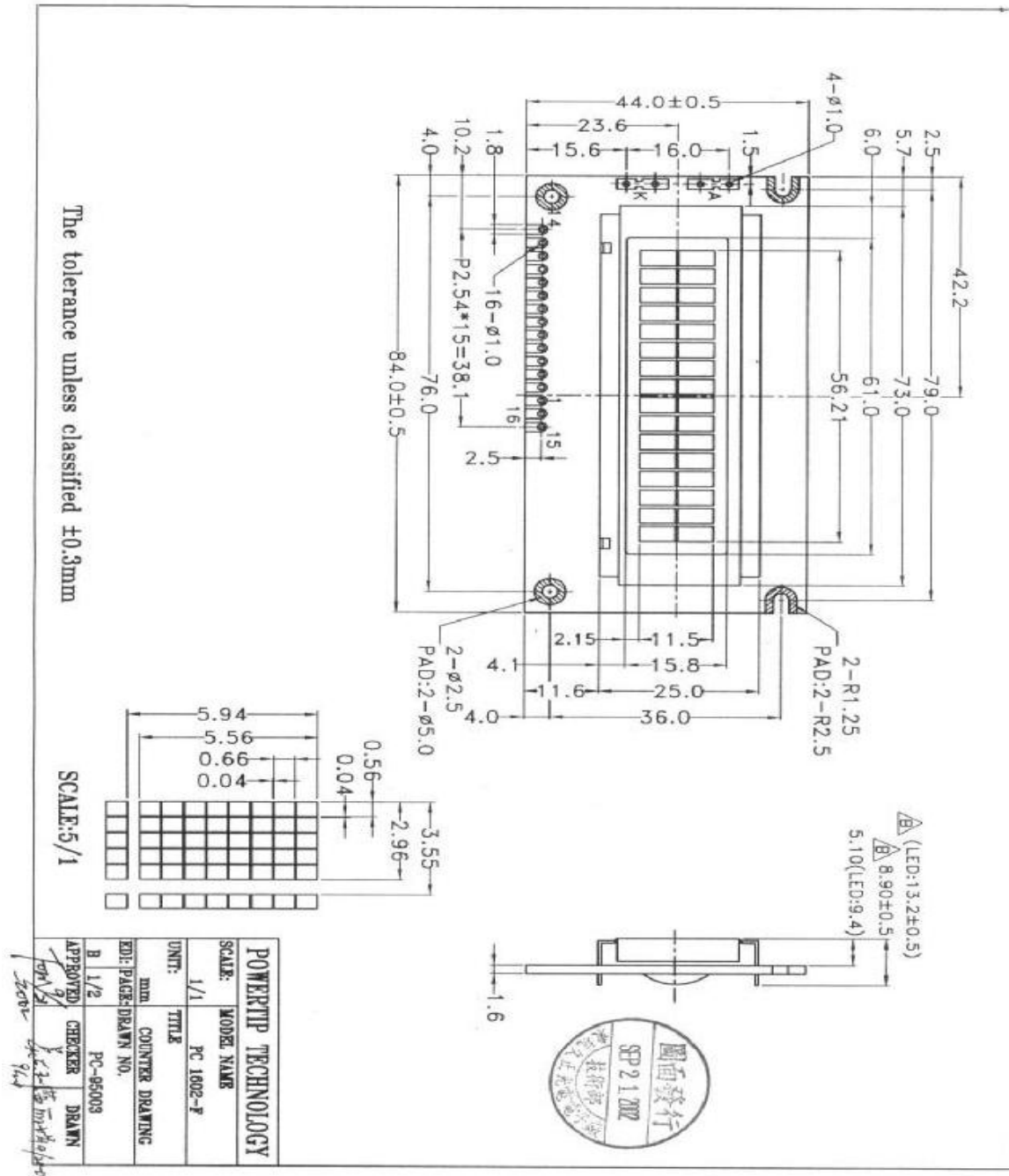

PIN NO.	SIGNAL
1	V _{ss}
2	V _{dd}
3	V _o
4	RS
5	R/W
6	E
7	DB0
8	DB1
9	DB2
10	DB3
11	DB4
12	DB5
13	DB6
14	DB7
15	A
16	K

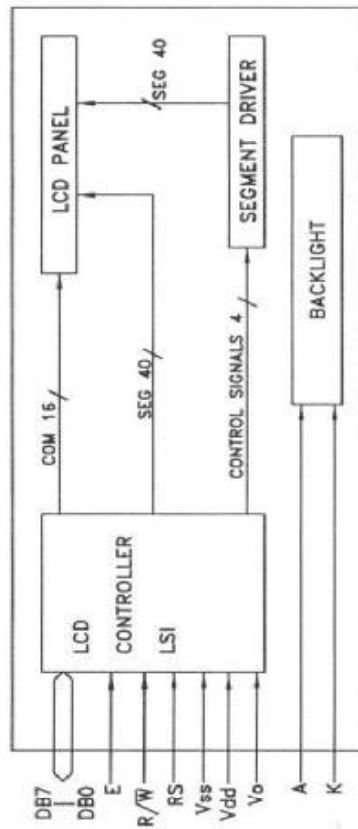

POWERTIP TECHNOLOGY	
SCALE:	MODEL NAME
NO SCALE	PC 1602-F
UNIT:	TITLE
NO UNIT	COUNTER DRAWING
ED: PAGE: DRAWN NO.	
B 1/2	PC-95003
APPROVED	CHECKER
10/11	DRAWN
2002	2002

2.2 Interface Pin Description

Pin No.	Symbol	Signal Description
1	V _{SS}	Power Supply (V _{SS} =0)
2	V _{DD}	Power Supply (V _{DD} >V _{SS})
3	V _O	NC
4	RS	Register Selection input High = Data register Low = Instruction register (for write) Busy flag address counter (for read)
5	$\overline{\text{R/W}}$	Read/Write signal input is used to select the read/write mode High = Read mode, Low = Write mode
6	E	Start enable signal to read or write the data
7~10	DB0 ~ DB3	Four low order bi-directional three-state data bus lines. Use for data transfer between the MPU and the LCD module. These four are not used during 4-bit operation.
11~14	DB4~DB7	Four high order bi-directional three-state data bus lines. Used for data transfer between the MPU and the LCD module. DB7 can be used as a busy flag.
15	A	Power supply for LED B/L (+)
16	K	Power supply for LED B/L (-)

Backlight controll

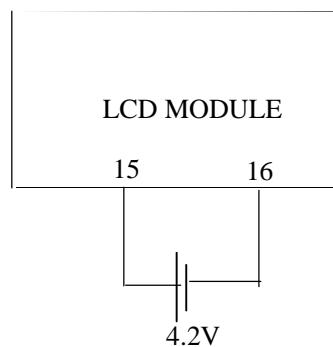

2.3 Timing Characteristics

- Writing data from MPU to ST7066U

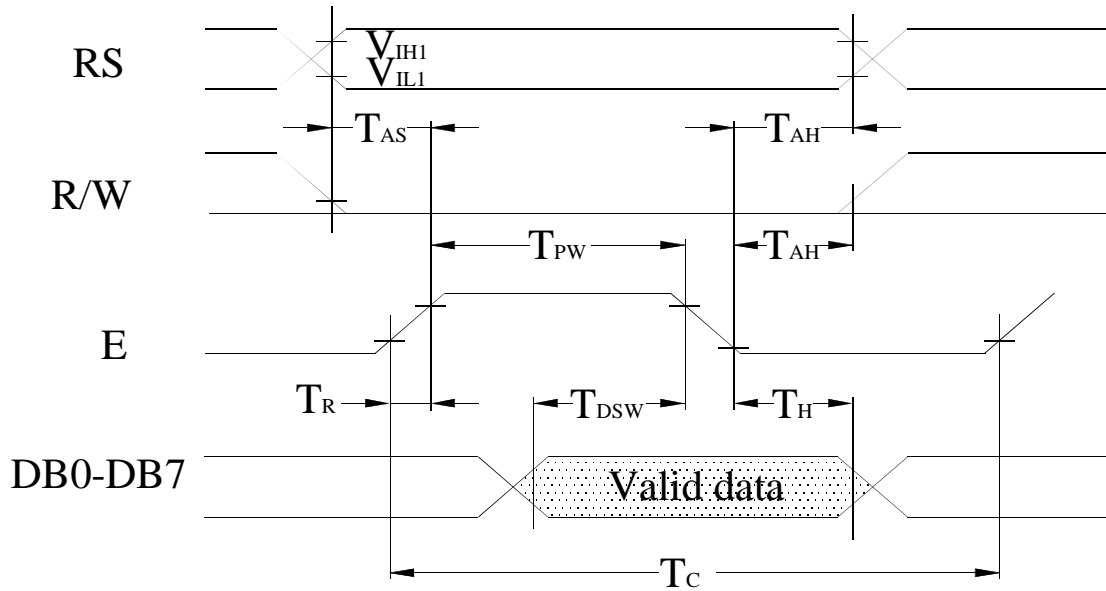

- Reading data from ST7066U to MPU

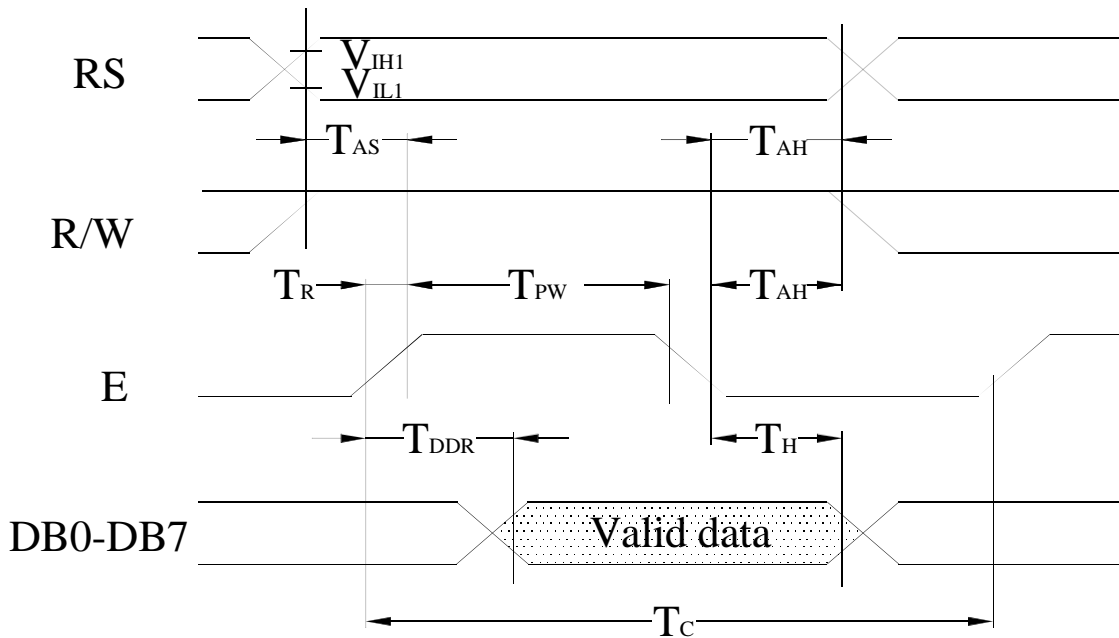

- Write Mode (Writing data from MPU to ST7066U)

(V_{cc} = +5V, T_a=25°C)

Symbol	Characteristics	Test Condition	Min.	Typ.	Max.	Unit
T _C	Enable Cycle Time	Pin E	1200	-	-	ns
T _{PW}	Enable Pulse Width	Pin E	140	-	-	ns
T _R , T _F	Enable Rise / Fall Time	Pin E	-	-	25	ns
T _{AS}	Address Setup Time	Pins: RS , RW,E	0	-	-	ns
T _{AH}	Address Hold Time	Pins :RS,RW,E	10	-	-	ns
T _{DSW}	Data Setup Time	Pins:DB0~DB7	40	-	-	ns
T _H	Data Hold Time	Pins:DB0~DB7	10	-	-	ns

- Read Mode (Reading data from ST7066U to MPU)

(V_{cc} = +5V, T_a=25°C)

Symbol	Characteristics	Test Condition	Min.	Typ.	Max.	Unit
T _C	Enable Cycle Time	Pin E	1200	-	-	ns
T _{PW}	Enable Pulse Width	Pin E	140	-	-	ns
T _R , T _F	Enable Rise / Fall Time	Pin E	-	-	25	ns
T _{AS}	Address Setup Time	Pins: RS , RW,E	0	-	-	ns
T _{AH}	Address Hold Time	Pins :RS,RW,E	10	-	-	ns
T _{DDR}	Data Setup Time	Pins:DB0~DB7	-	-	100	ns
T _H	Data Hold Time	Pins:DB0~DB7	10	-	-	ns

2.4 Display Command

Instructions	Instruction Code										Description	Description Time (270KHz)	
	RS	R/W	DB 7	DB 6	DB 5	DB 4	DB 3	DB 2	DB 1	DB 0			
Clear Display	0	0	0	0	0	0	0	0	0	0	1	Write "20H" to DDRAM. and set DDRAM address to "00H" from AC.	1.52ms
Return Home	0	0	0	0	0	0	0	0	0	1	×	Set DDRAM address to "00H" from AC and return cursor to it's original position if shifted. The contents of DDRAM are not changed.	1.52ms
Entry Mode Set	0	0	0	0	0	0	0	0	1	I/D	S	Sets cursor move direction and specifies display shift. These operations are performed during data write and read .	37 μ s
Display ON/OFF	0	0	0	0	0	0	0	1	D	C	B	D=1 : entire display on C=1 : cursor on B=1 : cursor position on	37 μ s
Cursor or Display Shift	0	0	0	0	0	0	1	S/C	R/L	×	×	Set cursor moving and display shift control bit, and the direction, without changing of DDRAM data.	37 μ s
Function Set	0	0	0	0	0	1	DL	N	F	×	×	DL: interface data is 8/4 bits NL: number of line is 2/1 F: font size is 5 \times 11/5 \times 8	37 μ s
Set CGRAM Address	0	0	0	1	AC 5	AC 4	AC 3	AC 2	AC 1	AC 0		Set CGRAM address in address counter.	37 μ s
Set DDRAM Address	0	0	1	AC 6	AC 5	AC 4	AC 3	AC 2	AC 1	AC 0		Set DDRAM address in address counter.	37 μ s

Read Busy Flag and Address	0	1	BF	AC 6	AC 5	AC 4	AC 3	AC 2	AC 1	AC 0	Whether during internal operation or not can be known by reading BF. The contents of address counter can also be read.	0 μ s
Write Data to RAM	1	0	D7	D6	D5	D4	D3	D2	D1	D0	Write data into internal RAM (DDRAM/CGRAM).	37 μ s
Read Data from RAM	1	1	D7	D6	D5	D4	D3	D2	D1	D0	Read data from internal RAM (DDRAM/CGRAM).	37 μ s

Note:

Be sure the ST7066U is not in the busy state (BF=0) before sending an instruction from the MPU to the ST7066.

If an instruction is sent without checking the busy flag , the time between the first instruction and next instruction will take much longer than the instruction time itself.

Refer to Instruction Table for the list of each instruction execution time .

2.5 Character Pattern

CHARACTER PATTERN(SO/HO/EA,WA)

Lower 4 Bits \ Upper 4 Bits		0000	0001	0010	0011	0100	0101	0110	0111	1000	1001	1010	1011	1100	1101	1110	1111
xxxx0000	CG RAM (1)			0	a	P	\	p				—	g	e	o	p	
xxxx0001	(2)		!	1	A	Q	a	a				a	f	t	c	a	g
xxxx0010	(3)		"	2	B	R	b	r				"	i	u	x	p	e
xxxx0011	(4)		#	3	C	S	c	s				#	o	t	e	e	w
xxxx0100	(5)		\$	4	D	T	d	t				\$	i	t	k	k	o
xxxx0101	(6)		%	5	E	U	e	u				%	o	t	a	u	o
xxxx0110	(7)		&	6	F	V	f	v				&	o	c	e	a	e
xxxx0111	(8)		'	7	G	W	g	w				'	t	a	g	g	a
xxxx1000	(1)		(8	H	X	h	x				(o	o	u	u	u
xxxx1001	(2))	9	I	Y	i	y)	o	t	u	u	u
xxxx1010	(3)		*	:	J	Z	j	z				*	o	o	u	u	u
xxxx1011	(4)		+	;	K	C	k	c				+	o	o	u	u	u
xxxx1100	(5)		,	<	L	*	l	l				,	o	o	u	u	u
xxxx1101	(6)		—	=	M	I	m	i				—	o	o	u	u	u
xxxx1110	(7)		.	>	N	^	n	^				.	o	o	u	u	u
xxxx1111	(8)		/	?	O	_	o	_				/	o	o	u	u	u

3. QUALITY ASSURANCE SYSTEM

3.1 Quality Assurance Flow Chart

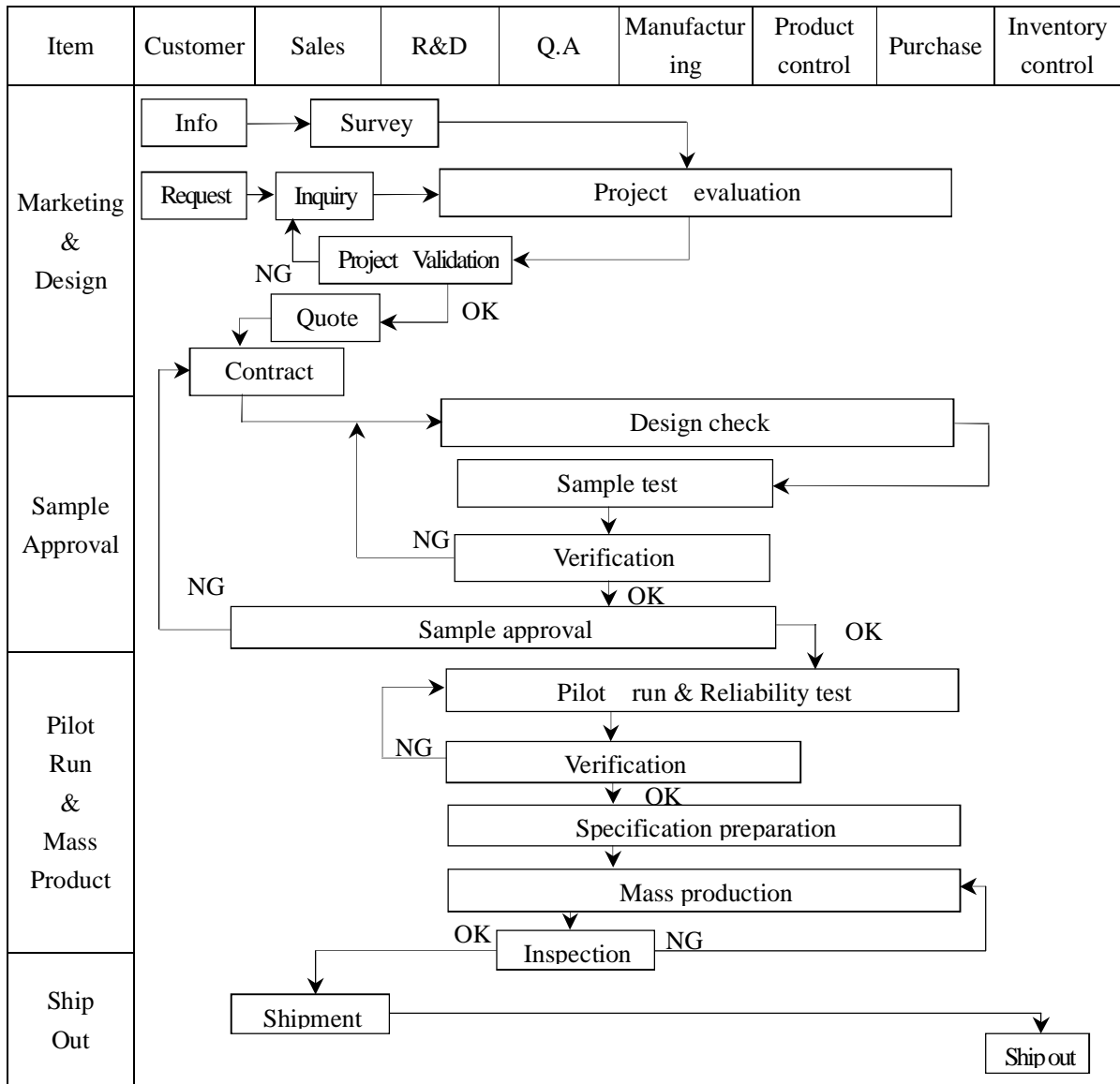

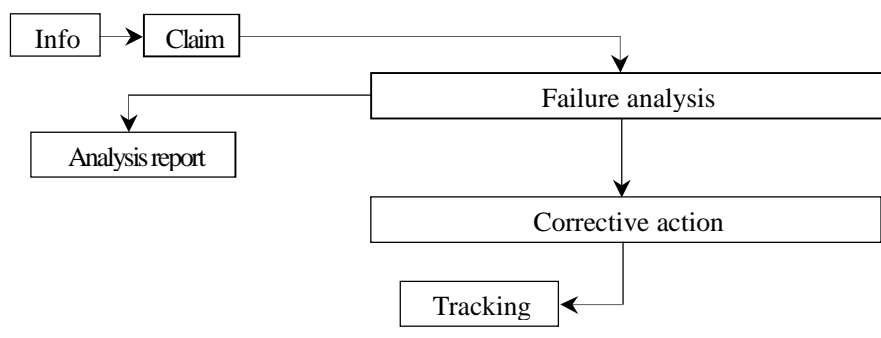
Item	Customer	Sales	R&D	Q.A	Manufacturing	Product control	Purchase	Inventory control
Sales Service	 <pre> graph TD Info[Info] --> Claim[Claim] Claim --> Failure[Failure analysis] Failure --> Report[Analysis report] Failure --> Action[Corrective action] Action --> Tracking[Tracking] </pre>							
Q.A Activity	1. ISO 9001 Maintenance Activities 3. Equipment calibration 5. Standardization Management				2. Process improvement proposal 4. Education And Training Activities			

3.2 Inspection Specification

Inspection Standard : MIL-STD-105E Table Normal Inspection Single Sampling Level II ◦

Equipment : Gauge 、 MIL-STD 、 Powertip Tester 、 Sample ◦

IQC Defect Level : Major Defect AQL 0.4; Minor Defect AQL 1.5 ◦

FQC Defect Level : 100% Inspection ◦

OUT Going Defect Level : Sampling ◦

Specification :

NO	Item	Specification	Judge	Level
1	Part Number	The part number is inconsistent with work order of production	N.G.	Major
2	Quantity	The quantity is inconsistent with work order of production	N.G.	Major
3	Electronic characteristics of LCM $A=(L+W)\div 2$	The display lacks of some patterns.	N.G.	Major
		Missing line.	N.G.	Major
		The size of missing dot, A is $> 1/2$ Dot size	N.G.	Major
		There is no function.	N.G.	Major
		Output data is error	N.G.	Major
4	Appearance of LCD $A=(L+W)\div 2$	Material is different with work order of production	N.G.	Major
		LCD is assembled in inverse direction	N.G.	Major
		Bezel is assembled in inverse direction	N.G.	Major
		Shadow is within LCD viewing area + 0.5 mm	N.G.	Major
		The diameter of dirty particle, A is > 0.4 mm	N.G.	Minor
	Dirty particle (Including scratch 、 bubble)	Dirty particle length is > 3.0 mm, and 0.01 mm $<$ width ≤ 0.05 mm	N.G.	Minor
		Display is without protective film	N.G.	Minor
		Conductive rubber is over bezel 1mm	N.G.	Minor
		Polarizer exceeds over viewing area of LCD	N.G.	Minor
		Area of bubble in polarizer, A > 1.0 mm, the number of bubble is > 1 piece.	N.G.	Minor
5	Appearance of PCB $A=(L+W)\div 2$	0.4mm $<$ Area of bubble in polarizer, A < 1.0 mm, the number of bubble is > 4 pieces.	N.G.	Minor
		Burned area or wrong part number is on PCB	N.G.	Major
		The symbol, character, and mark of PCB are unidentifiable.	N.G.	Minor
		The stripped solder mask , A is > 1.0 mm	N.G.	Minor
		0.3mm $<$ stripped solder mask or visible circuit, A < 1.0 mm, and the number is ≥ 4 pieces	N.G.	Minor
		There is particle between the circuits in solder mask	N.G.	Minor
		The circuit is peeled off or cracked	N.G.	Minor
		There is any circuits risen or exposed.	N.G.	Minor
		0.2mm $<$ Area of solder ball, A is ≤ 0.4 mm	N.G.	Minor
The number of solder ball is ≥ 3 pieces	N.G.	Minor		
The magnitude of solder ball, A is > 0.4 mm.	N.G.	Minor		

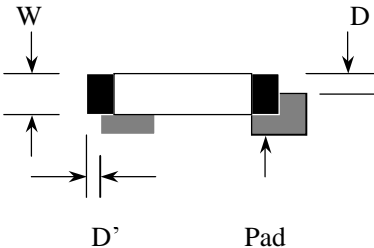
NO	Item	Specification	Judge	Level
6	Appearance of molding $A=(L+W)\div 2$	The shape of modeling is deformed by touching.	N.G.	Major
		Insufficient epoxy: Circuit or pad of IC is visible	N.G.	Minor
		Excessive epoxy: Diameter of modeling is $>20\text{mm}$ or height is $>2.5\text{mm}$	N.G.	Minor
		The diameter of pinhole in modeling, A is $>0.2\text{mm}$.	N.G.	Minor
7	Appearance of frame $A=(L+W)\div 2$	The folding angle of frame must be $>45^\circ +10^\circ$	N.G.	Minor
		The area of stripped electroplate in top-view of frame, A is $>1.0\text{mm}$.	N.G.	Minor
		Rust or crack is (Top view only)	N.G.	Minor
		The scratched width of frame is $>0.06\text{mm}$. (Top view only)	N.G.	Minor
8	Electrical characteristic of backlight $A=(L+W)\div 2$	The color of backlight is nonconforming	N.G.	Major
		Backlight can't work normally.	N.G.	Major
		The LED lamp can't work normally	N.G.	Major
		The unsoldering area of pin for backlight, A is $>1/2$ solder joint area.	N.G.	Minor
		The height of solder pin for backlight is $>2.0\text{mm}$	N.G.	Minor
10	Assembly parts $A=(L+W)\div 2$	The mark or polarity of component is unidentifiable.	N.G.	Minor
		The height between bottom of component and surface of the PCB is floating $>0.7\text{mm}$	N.G.	Minor
		$D > 1/4W$ 	N.G.	Minor
		End solder joint width, D' is $>50\%$ width of component termination or width of pad	N.G.	Minor
		Side overhang, D is $>25\%$ width of component termination.	N.G.	Minor
		Component is cracked, deformed, and burned, etc.	N.G.	Minor
		The polarity of component is placed in inverse direction.	N.G.	Minor
		Maximum fillet height of solder extends onto the component body or minimum fillet height is $<0.5\text{mm}$.	N.G.	Minor

4. RELIABILITY TEST

4.1 Reliability Test Condition

NO	Item	Test Condition	
1	High Temperature Storage	Storage at $80 \pm 2^{\circ}\text{C}$ 96~100 hrs Surrounding temperature, then storage at normal condition 4hrs	
2	Low Temperature Storage	Storage at $-30 \pm 2^{\circ}\text{C}$ 96~100 hrs Surrounding temperature, then storage at normal condition 4hrs	
3	High Temperature /Humidity Storage	1.Storage 96~100 hrs $60 \pm 2^{\circ}\text{C}$, 90~95%RH surrounding temperature, then storage at normal condition 4hrs. (Excluding the polarizer). or 2.Storage 96~100 hrs $40 \pm 2^{\circ}\text{C}$, 90~95%RH surrounding temperature, then storage at normal condition 4 hrs.	
4	Temperature Cycling	$-20^{\circ}\text{C} \rightarrow 25^{\circ}\text{C} \rightarrow 70^{\circ}\text{C} \rightarrow 25^{\circ}\text{C}$ $\leftarrow (30\text{mins}) (5\text{mins}) (30\text{mins}) (5\text{mins}) \rightarrow$ 10 Cycle	
5	Vibration	10~55Hz (1 minute) 1.5mm X,Y and Z direction * (each 2hrs)	
6	ESD Test	Air Discharge: Apply 6 KV with 5 times discharge for each polarity +/-	Contact Discharge: Apply 250V with 5 times discharge for each polarity +/-
		Testing location: Around the face of LCD	Testing location: 1.Apply to bezel. 2.Apply to Vdd, Vss.
7	Drop Test	Packing Weight (Kg)	Drop Height (cm)
		0 ~ 45.4	122
		45.4 ~ 90.8	76
		90.8 ~ 454	61
		Over 454	46



5. PRECAUTION RELATING PRODUCT HANDLING

5.1 SAFETY

- 5.1.1 If the LCD panel breaks , be careful not to get the liquid crystal to touch your skin.
- 5.1.2 If the liquid crystal touches your skin or clothes , please wash it off immediately by using soap and water.

5.2 HANDLING

- 5.2.1 Avoid any strong mechanical shock which can break the glass.
- 5.2.2 Avoid static electricity which can damage the CMOS LSI—When working with the module , be sure to ground your body and any electrical equipment you may be using.
- 5.2.3 Do not remove the panel or frame from the module.
- 5.2.4 The polarizing plate of the display is very fragile. So , please handle it very carefully ,do not touch , push or rub the exposed polarizing with anything harder than an HB pencil lead (glass , tweezers , etc.)
- 5.2.5 Do not wipe the polarizing plate with a dry cloth , as it may easily scratch the surface of plate.
- 5.2.6 Do not touch the display area with bare hands , this will stain the display area.
- 5.2.7 Do not use ketonics solvent & aromatic solvent. Use with a soft cloth soaked with a cleaning naphtha solvent.
- 5.2.8 To control temperature and time of soldering is $280\pm 10^{\circ}\text{C}$ and 3-5 sec.
- 5.2.9 To avoid liquid (include organic solvent) stained on LCM .

5.3 STORAGE

- 5.3.1 Store the panel or module in a dark place where the temperature is $25^{\circ}\text{C} \pm 5^{\circ}\text{C}$ and the humidity is below 65% RH.
- 5.3.2 Do not place the module near organics solvents or corrosive gases.
- 5.3.3 Do not crush , shake , or jolt the module.

5.4 TERMS OF WARRANTY

- 5.4.1 Applicable warrant period
The period is within thirteen months since the date of shipping out under normal using and storage conditions.
- 5.4.2 Unaccepted responsibility
This product has been manufactured to your company's specification as a part for use in your company's general electronic products. It is guaranteed to perform according to delivery specifications. For any other use apart from general electronic equipment , we cannot take responsibility if the product is used in nuclear power control equipment , aerospace equipment , fire and security systems or any other applications in which there is a direct risk to human life and where extremely high levels of reliability are required.