

# Photo interrupter, double-layer mold type

## RPI-124

The RPI-124 is an ultra-small size, double-layer mold photointerrupter.

● External dimensions (Units: mm)

● Applications

Optical control equipment  
Cameras  
Floppy disk drives

● Features

- 1) Ultra-small.
- 2) High-precision position detection (slit width = 0.15 mm).
- 3) Minimal influence from stray light.
- 4) Low collector-emitter saturation voltage.

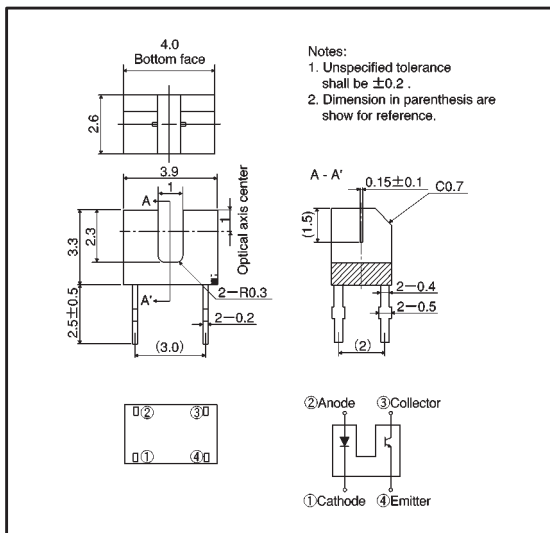

● Absolute maximum ratings (Ta = 25°C)

	Parameter	Symbol	Limits	Unit
Input(LED)	Forward current	I <sub>F</sub>	50	mA
	Reverse voltage	V <sub>R</sub>	5	V
	Power dissipation	P <sub>D</sub>	80	mW
Output (photo-transistor)	Collector-emitter voltage	V <sub>CEO</sub>	30	V
	Emitter-collector voltage	V <sub>ECO</sub>	4.5	V
	Collector current	I <sub>C</sub>	30	mA
	Collector power dissipation	P <sub>C</sub>	80	mW
	Operating temperature	T <sub>opr</sub>	-25~+85	°C
	Storage temperature	T <sub>stg</sub>	-30~+100	°C

●Electrical and optical characteristics (Ta = 25°C)

Parameter		Symbol	Min.	Typ.	Max.	Unit	Conditions
Input characteristics	Forward voltage	$V_F$	—	1.3	1.6	V	$I_F=50\text{mA}$
	Reverse current	$I_R$	—	—	10	$\mu\text{A}$	$V_R=5\text{V}$
	Dark current	$I_{CEO}$	—	—	0.5	$\mu\text{A}$	$V_{CE}=10\text{V}$
Output characteristics	Peak sensitivity wavelength	$\lambda_P$	—	800	—	nm	—
Transfer characteristics	Collector current	$I_C$	0.3	—	1.5	mA	$V_{CC}=5\text{V}, I_F=20\text{mA}$
	Collector-emitter saturation voltage	$V_{CE(sat)}$	—	—	0.3	V	$I_F=20\text{mA}, I_C=0.15\text{mA}$
	Response time	$t_r \cdot t_f$	—	10	—	$\mu\text{s}$	$V_{CC}=5\text{V}, I_F=20\text{mA}, R_L=100\Omega$

●Electrical and optical characteristic curves

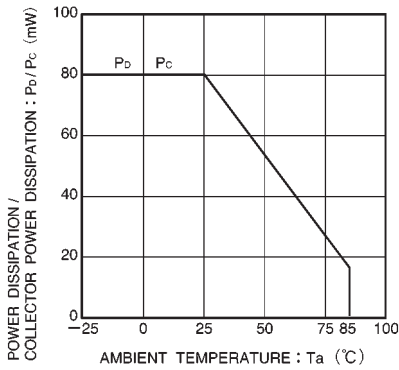

Fig.1 Power dissipation / collector power dissipation vs. ambient temperature

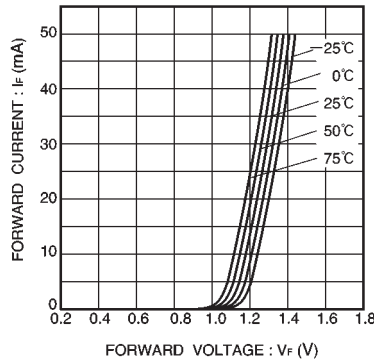

Fig.2 Forward current vs. forward voltage

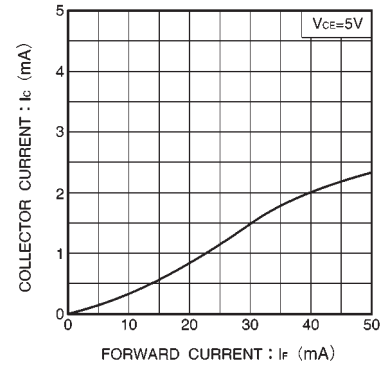

Fig.3 Collector current vs. forward current

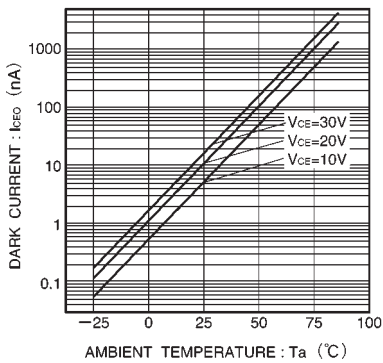

Fig.4 Dark current vs. ambient temperature

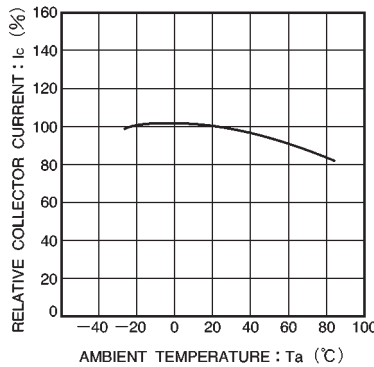

Fig.5 Relative output vs. ambient temperature

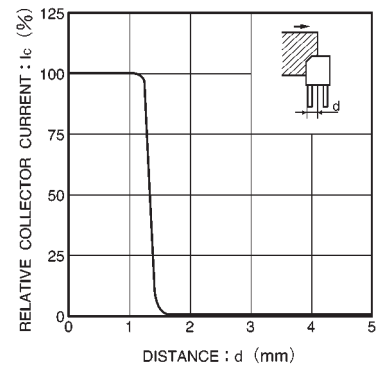

Fig.6 Relative output current vs. distance (I)

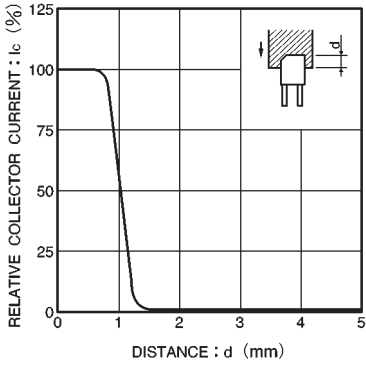

Fig.7 Relative output current vs. distance (II)

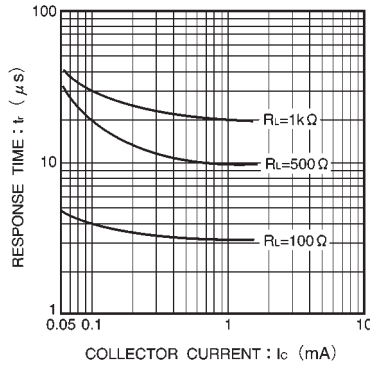

Fig.8 Response time vs. collector current

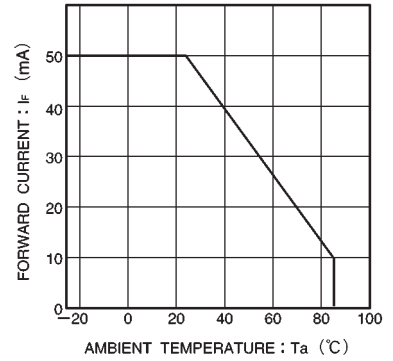

Fig.9 Forward current falloff

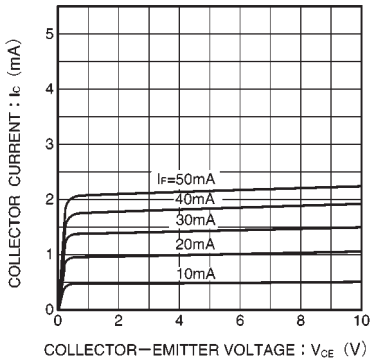
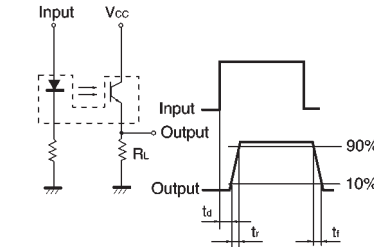

Fig.10 Output characteristics



$t_d$ : Delay time  
 $t_r$ : Rise time (time for output current to rise from 10% to 90% of peak current)  
 $t_f$ : Fall time (time for output current to fall from 90% to 10% of peak current)

Fig.11 Response time measurement circuit