

DATA SHEET

CX74063-26: RF Transceiver for Multi-Band GSM, GPRS, and EDGE Applications with Power Ramping Controller and Integrated Crystal Oscillator with 26 MHz Output

APPLICATIONS

- GSM850, EGSM900, DCS1800, and PCS1900 handsets
- GPRS handsets and modules
- EDGE downlink support

FEATURES

- Direct down-conversion receiver eliminates the external image reject/IF filters
- Three separate LNAs with single-ended inputs
- RF gain range: GSM = 20 dB, DCS = 22 dB, PCS = 20 dB. Baseband gain range = 100 dB
- Gain selectable in 2 dB steps
- Integrated receive baseband filters with tunable bandwidth
- Integrated DC offset correction sequencer
- Reduced filtering requirements with translational loop transmit architecture
- Integrated transmit VCOs
- Wide RF range for quad band operation
- Integrated PAC loop
- Single integrated, fully programmable fractional-N synthesizer suitable for multi-slot GPRS operation
- Fully integrated wideband Ultra High Frequency (UHF) VCO
- Integrated crystal oscillator
- Separate enable lines for power management transmit, receive, and synthesizer modes
- Supply voltage down to 2.6 V
- Band select and front-end enable states may be exercised on output pins to control external circuitry
- Low external component count
- Optional bypass of baseband filtering for use with high dynamic range Analog to Digital Converters (ADCs) for current savings
- Interfaces to low dynamic range ADC
- Meets AM suppression requirements without baseband interaction
- 56-pin RFLGA 8x8 mm package
- Low power standby mode

DESCRIPTION

The CX74063-26 transceiver is a highly integrated device for multi-band Global System for Mobile Communications™ (GSM™) or General Packet Radio Service (GPRS) applications. The device requires a minimal number of external components to complete a GSM radio subsystem. The CX74063-26 supports GSM850, EGSM900, DCS1800, and PCS1900 applications. The receiver also supports downlink Enhanced Data-Rate GSM Evolution (EDGE).

The receive path implements a direct down-conversion architecture that eliminates the need for Intermediate Frequency (IF) components. The CX74063-26 receiver consists of three integrated Low Noise Amplifiers (LNAs), a quadrature demodulator, tunable receiver baseband filters, and a DC-offset correction sequencer.

In the transmit path, the device consists of an In-phase and Quadrature (I/Q) modulator within a frequency translation loop designed to perform frequency up-conversion with high output spectral purity. This loop also contains a phase-frequency detector, charge pump, mixer, programmable dividers, and high power transmit Voltage Controlled Oscillators (VCOs) with no external tank required. With the integrated gain controller (and an integrator), the device realizes the Power Amplifier Control (PAC) functionality when combined with a coupler, a Radio Frequency (RF) detector and a Power Amplifier (PA).

The CX74063-26 also features an integrated, fully programmable, sigma-delta fractional-N synthesizer suitable for GPRS multi-slot operation. Except for the loop filter, the frequency synthesizer function, including a wideband VCO, is completely on-chip. The reference frequency for the synthesizer is supplied by the integrated crystal oscillator circuitry.

The 56-pin 8x8 RF Land Grid Array (RFLGA™) device package and pin configuration are shown in Figure 1. A functional block diagram is shown in Figure 2. Signal pin assignments, functional pin descriptions, and equivalent circuitry are provided in Table 1.

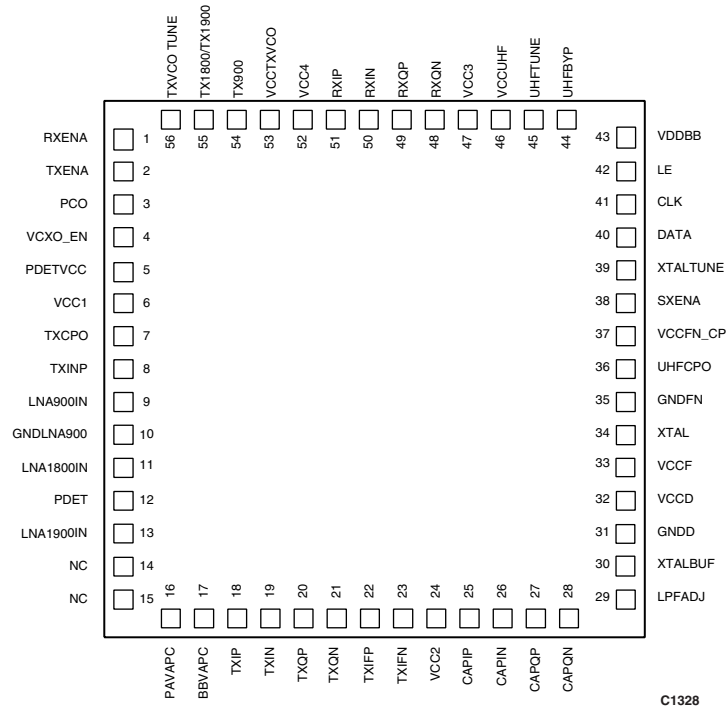

Figure 1. CX74063-26 Pinout – 56-Pin RFLGA (8 x 8 mm) (Top View)

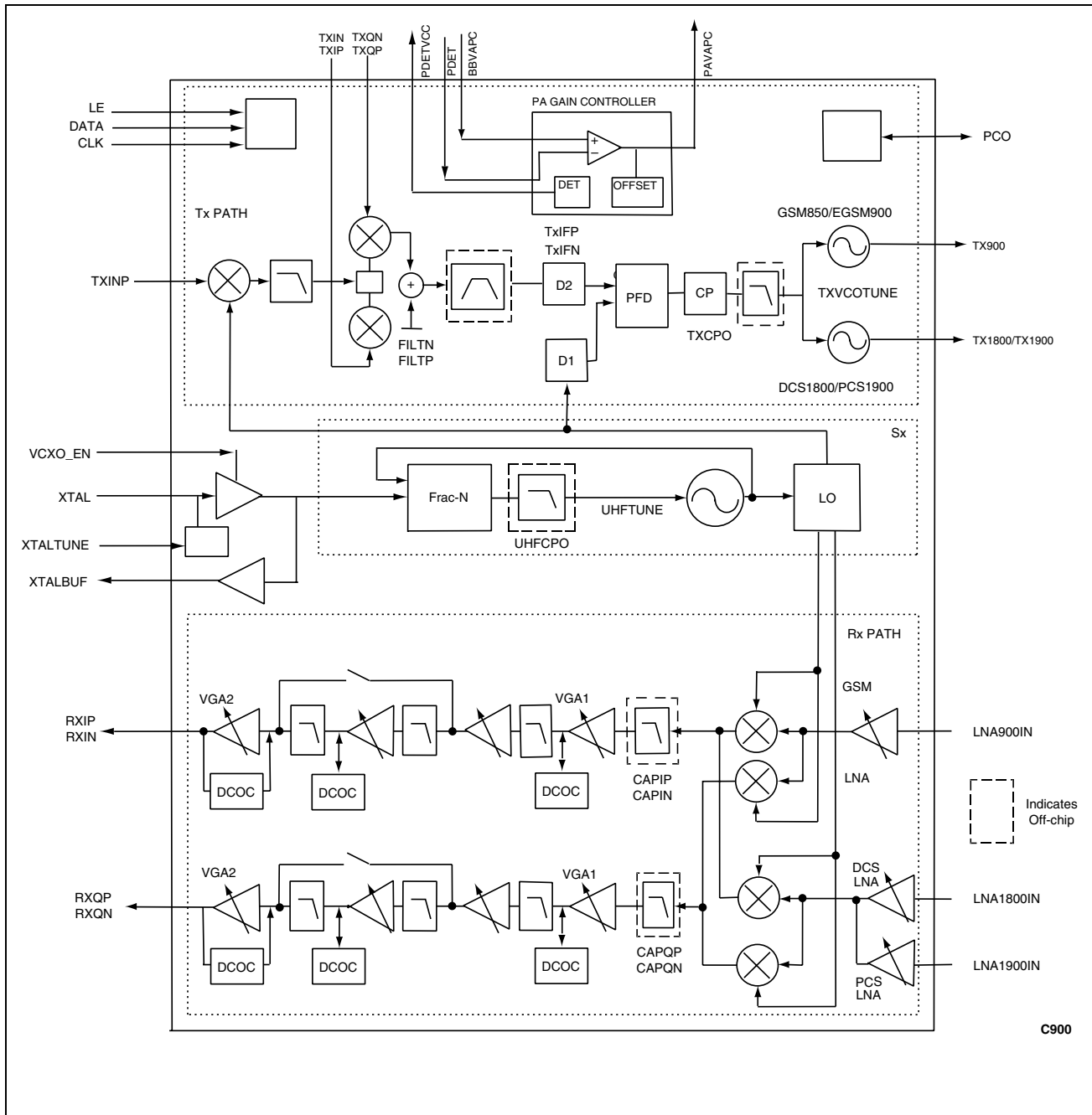

Figure 2. CX74063-26 Transceiver Block Diagram

Table 1. CX74063-26 Signal Descriptions (1 of 5)

Pin #	Name	Description	Equivalent Circuit
1	RXENA	Receiver enable input	
2	TXENA	Transmitter enable input	
3	PCO	Bi-directional band select	
4	VCXO_EN	VCXO enable pin	
5	PDETVCC	Bias for the RF Detector	
6	VCC1	LNA and TX charge pump supply	VCC1
7	TXCPO	Translational loop charge pump output	
8	TXINP	Translational loop feedback input	
9	LNA900IN	Low band LNA input for GSM850, EGSM900	
10	GNDLNA900	Low band LNA emitter ground	

Table 1. CX74063-26 Signal Descriptions (2 of 5)

Pin #	Name	Description	Equivalent Circuit
11	LNA1800IN	DCS LNA input	
12	PDET	Feedback Input to power control loop	
13	LNA1900IN	PCS LNA input	
14	NC	No connect	No connect
15	NC	No connect	No connect
16	PAVAPC	PA control output	
17	BBVAPC	PA control Baseband input	
18	TXIP	TX I baseband input positive	
19	TXIN	TX I baseband input negative	
20	TXQP	TX Q baseband input positive	
21	TXQN	TX Q baseband input negative	
22	TXFP	TX IF filter output positive	
23	TXFN	TX IF filter output negative	

Table 1. CX74063-26 Signal Descriptions (3 of 5)



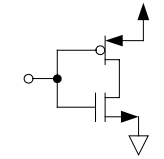
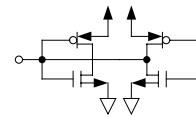
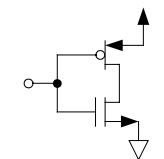
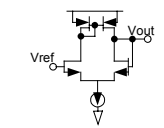
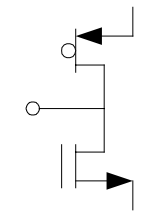
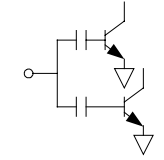
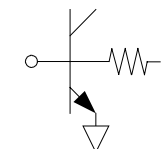
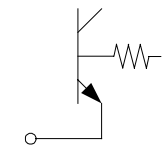

Pin #	Name	Description	Equivalent Circuit
24	VCC2	RX mixer and TX loop supply	VCC2
25	CAPIP	Capacitor filter I positive	
26	CAPIN	Capacitor filter I negative	
27	CAPQP	Capacitor filter Q positive	
28	CAPQN	Capacitor filter Q negative	
29	LPFADJ	LPF frequency setting resistor	
30	XTALBUF	Crystal oscillator buffer output	
31	GNDD	Synthesizer digital ground	
32	VCCD	Synthesizer digital supply	VCCD
33	VCCF	Synthesizer analog supply and crystal oscillator supply	VCCF
34	XTAL	Crystal input	
35	GNDFN	Synthesizer analog ground	

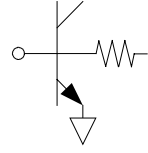
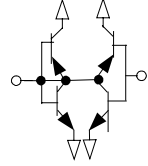
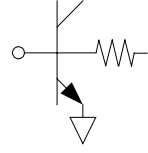
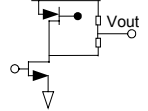
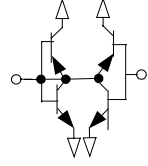
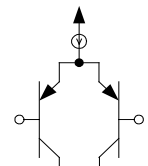
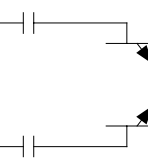
Table 1. CX74063-26 Signal Descriptions (4 of 5)

Pin #	Name	Description	Equivalent Circuit
36	UHFCPO	Synthesizer charge pump output	
37	VCCFN_CP	Synthesizer charge pump supply	VCCFN_CP
38	SXENA	Synthesizer enable input	
39	XTALTUNE	Crystal oscillator varactor control	
40	DATA	Serial bus data input	
41	CLK	Serial bus clock input	
42	LE	Serial bus latch enable input	
43	VDDBB	Digital CMOS supply	VDDBB
44	UHFBYP	Bypass capacitor for UHF VCO	
45	UHFTUNE	UHF VCO control input	
46	VCCUHF	UHF VCO supply	VCCUHF
47	VCC3	LO chain supply	VCC3

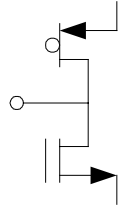
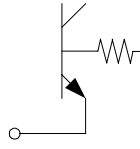
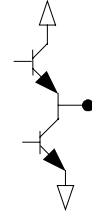
Table 1. CX74063-26 Signal Descriptions (5 of 5)

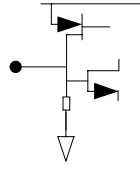
Pin #	Name	Description	Equivalent Circuit
48	RXQN	Receiver output Q negative	
49	RXQP	Receiver output Q positive	
50	RXIN	Receiver output I negative	
51	RXIP	Receiver output I positive	
52	VCC4	Baseband supply	VCC4
53	VCCTXVCO	Transmit VCO supply	VCCTXVCO
54	TX900	Low band transmit VCO	
55	TX1800/TX1900	DCS and PCS transmit VCO output	
56	TXVCOTUNE	Transmit VCO control input	

Technical Description

The CX74063-26 transceiver contains the following sections, as shown in Figure 2.

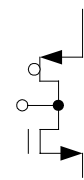
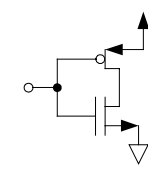
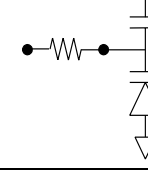
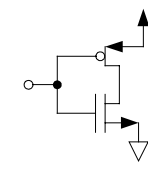
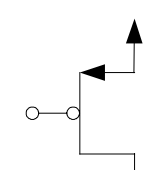
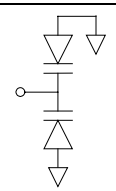
- **Receive section.** Includes three integrated LNAs, a quadrature demodulator section that performs direct down conversion, baseband amplifier circuitry with I/Q outputs, and three stages of DC offset correction. The receiver can be calibrated to optimize IP2 performance.
- **Synthesizer section.** Includes an integrated on-chip VCO locked by a fractional-N synthesizer loop, and a crystal oscillator to supply the reference frequency.
- **Transmit section.** The TX path is a translational loop architecture consisting of an I/Q modulator, integrated high power VCOs, offset mixer, programmable divider, PFD, and charge pump. The device also provides integrated gain controller for the PAC loop, plus the bias generator for an external diode detector.

A 3-wire serial interface controls the transceiver and synthesizer. The receiver gain control, as well as the division ratios and charge pump currents in the synthesizer and transmitter, can be programmed using 24-bit words. These 24-bit words are programmed using the 3-wire input signals CLK, DATA, and LE. Pin 43 (VDDBB) is provided for the digital sections to allow power supply operation compatible with modern digital baseband devices. VDDBB is also used to supply registers 0 through 5 to maintain programmed values.

The TXENA, RXENA, and SXENA signals separately enable the CX74063-26 transmitter, receiver, and synthesizer sections.

TXENA and RXENA should be held low during programming. SXENA should be held high during the programming of register 3 (IP2 calibration). (These timing signals are detailed in Figures 9, 10, and 11.)

Receive Section

LNA and Quadrature Demodulator

Three separate LNAs are integrated to address different bands of operation. These LNAs have separate single-ended inputs, which are externally matched to 50 Ω . The gain is switchable between high (i.e., 15 dB typical) and low (i.e., -5 dB GSM, -7 dB DCS, and -5 dB PCS typical) settings. The LNA outputs feed into a quadrature demodulator that downconverts the RF signals directly to baseband. Two external 470 pF capacitors are required at the demodulator output to suppress the out-of-band blockers.

Baseband Section

An off-chip capacitor and three fixed poles of on-chip, low pass filtering provide rejection of strong in- and out-of-band interferers. In addition, a tunable, four-pole gmC filter provides rejection of the adjacent channel blockers. Incorporated within the fixed-pole filters are two switchable gain stages of 18 dB and 12 dB gain steps, respectively. There is an additional programmable gain amplifier with a gain range from 0 to + 34 dB, selectable in 2 dB steps in the four-pole tunable filter. The final filter output feeds an amplifier with a gain range from 0 to 30 dB, selectable in 6 dB steps.

There is an additional gain stage on the four-pole tunable filter output, the auxiliary gain stage, selectable at 0 dB or + 6 dB.

The gain control ranges are shown in Figure 3.

Recommended combinations of individual block gain settings are shown in Table 22 for GSM900, Table 23 for DCS1800, and Table 24 for PCS1900.

For added baseband interface flexibility, the four-pole filter, its associated Variable Gain Amplifier (VGA), and DC offset correction loop can be bypassed and turned off for current savings.

In Table 2 the typical locations of all eight receiver baseband poles are given. The final four poles are produced by the tunable gmC filter, as set by the external resistor (recommended value is 39.2 k Ω , 1%) placed from pin 29 to ground.

For these tunable poles, Table 2 gives the pole location as a function of this resistor.

DC Offset Correction

Three DC offset correction (DCOC) loops ensure that DC offsets, generated in the CX74063-26, do not overload the baseband chain at any point. After compensation, the correction voltages are held on capacitors for the duration of the receive slot(s). Internally, on-chip timing is provided to generate the track and hold (T_H) signals for the three correction loops.

The timing diagram for the DC offset correction sequence with reference to the receive slot is shown in Figure 4. A rising edge on either the RXENA signal, selected via the serial interface, places the DC compensation circuitry in the track mode.

The timing parameters for each of the three compensation loops, $t_{L,H1}$, $t_{L,H2}$, and $t_{L,H3}$, and the time between compensation start and the LNA being turned on, t_{FEENA} , are defined via an internal state machine. The state machine is preprogrammed with fixed default values, but may be readjusted via the serial interface.

The timing parameters for the three compensation loops and the LNA power-up are each independently defined, relative to the compensation start. Therefore, they may be programmed to occur in any order, but the sequences shown in Figure 4 and Figure 5 are recommended. The device default timing is shown in Figure 5, with a total time of 60 μ s. Individual default timings are given in Table 17. For user-programmed timing, the total time may be set as short as approximately 10 μ s when FREF has a 13 MHz clock applied. However, the shortest recommended total time is approximately 30 μ s, since at the highest gain settings, the resulting DC may degrade as correction time is reduced.

AM Suppression and IP2 Calibration

For direct conversion GSM applications, it is imperative to have extremely low second-order distortion. Mathematically, second-order distortion of a constant tone generates a DC-term proportional to the square of the amplitude. A strong interfering amplitude-modulated (AM) signal is therefore demodulated by second-order distortion in the receiver front end, and generates an interfering baseband signal.

Table 2. Receive Pole Locations

Stage	Typical Pole Location (rad/sec)	Pole Type
Mixer + RC Filter	-1.0×10^6	Real (capacitors at pins 25-26 and 27-28 fixed at 470 pF)
	-1.65×10^6	Real
LPF1	$(-0.91 \times 10^6) \pm j(1.35 \times 10^6)$	Conjugate
VGA1 + gmC filter	$(-0.91 \times 10^6) \times (39.2 \text{ k}\Omega/R)$	Real (adjust with resistor at pin 29)
	$(-0.91 \times 10^6) \times (39.2 \text{ k}\Omega/R)$	Real (adjust with resistor at pin 29)
	$[(-0.46 \times 10^6) \pm j(1.0 \times 10^6)] \times (39.2 \text{ k}\Omega/R)$	Conjugate (adjust with resistor at pin 29)

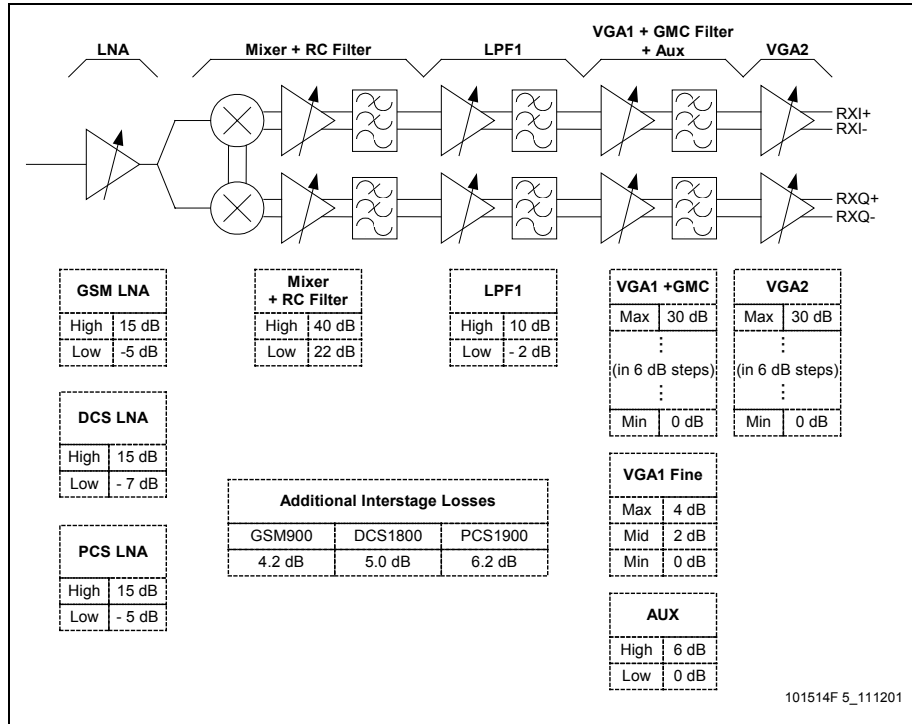

Figure 3. Gain Control Settings

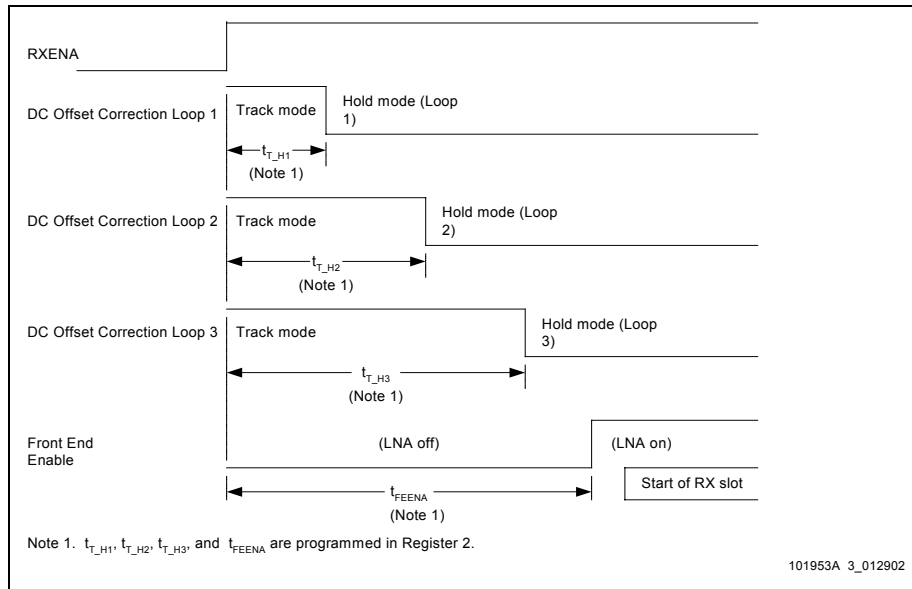

Figure 4. DC Offset Correction Timing (LNA Off During All of the DC Offset Correction Sequence)

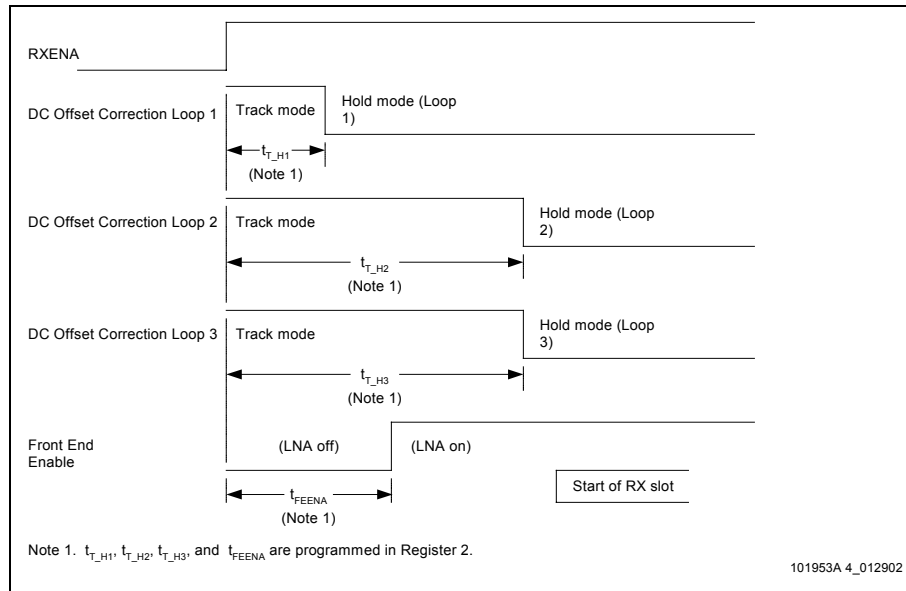

Figure 5. DC Offset Correction Timing (LNA On During Part of the DC Offset Correction Sequence)

A commonly used measure for receiver second-order distortion is the second-order intercept point, IP2. For example, to ensure that the unwanted baseband signals are 9 dB below the wanted signal required under the AM suppression test for type approval (see 3GPP TS 51.010-1), an input IP2 of 43 dBm is required:

The CX74063-26 receiver includes a circuit that minimizes second-order distortion. This IP2 calibration circuit effectively compensates any second-order distortion in the receive chain that would otherwise generate unwanted baseband signals in the presence of strong interfering signals. When calibrated correctly, the CX74063-26 IP2 meets the GSM AM suppression test requirements in all bands with good margin.

To calibrate IP2, apply a strong RF signal at the receiver input and observe the resulting DC voltage level change at the receiver I/Q outputs. The exact frequency and level of the signal applied for the purpose of the calibration are not critical. The signal should, however, be within the receive band, but at least 6 MHz offset from the frequency to which the receiver is tuned. The level should be high enough to cause a notable DC shift at the I/Q outputs. A recommended value is -30 dBm at the LNA input, which applies to all three LNAs.

A set of I/Q compensation coefficients can then be programmed to the device to minimize the DC voltage shift resulting from the second-order distortion. When the DC due to the interfering signal is minimized, the IP2 performance is optimized.

Note: *SXENA, pin 38, must be held high, and a clock signal must be present on XTAL, pin 34, during the programming of the IP2 calibration coefficients in register 3, see Table 18.*

The IP2 calibration is a one-time factory calibration that should be done for each band and each individual device for optimum performance. The determined coefficients must be stored in nonvolatile memory and programmed to the CX74063-26 upon each power-up as part of device initialization. There are on-chip registers that must be programmed through register 3 with the appropriate IP2 coefficients for the band in use.

As long as a supply voltage is maintained on pin 43, VDDBB, the IP2 coefficients for I_{Lowband} , I_{Highband} , Q_{Lowband} , Q_{Highband} , programmed to the device remain in the registers. After the supply voltage has been removed from VDDBB, the coefficients must be re-programmed to the device again.

Synthesizer Section

The CX74063-26 includes a fully integrated UHF VCO with an on-chip LC tank.

A single sigma-delta fractional-N synthesizer can phase-lock the local oscillator used in both transmit and receive paths to a precision frequency reference input. Fractional-N operation offers low phase noise and fast settling times, allowing for multiple slot applications such as GPRS. The CX74063-26 frequency stepping function with a 3 Hz resolution allows triple band operation in both transmit and receive bands using a fully integrated single integrated on-chip UHF VCO. The fine synthesizer resolution allows direct compensation or adjustment for reference frequency errors.

The fractional-N synthesizer consists of the following:

- VCO
- High frequency prescaler
- N-divider with a sigma-delta modulator
- Reference buffer and divider
- Fast phase frequency detector and charge pump

The user must provide the following three parameters:

- The reference divider value, from 1 to 15
- The N-divider value, in a manner similar to an integer-N synthesizer
- A fractional ratio

The generated frequency is given by the following equation:

$$f_{VCO} = \frac{\left(N + 3.5 + \frac{FN}{2^{22}}\right) f_{ref}}{R}$$

where: f_{VCO} = Generated VCO frequency
 N = N-divider ratio integer part
 FN = Fractional setting
 R = R-divider ratio
 f_{REF} = Reference frequency

UHF VCO Frequency Setting

For the receiver, to tune the receive frequency, f_{RX} , set the VCO frequency, f_{VCO} , as follows:

- $f_{VCO} = \frac{3}{2} f_{RX}$ for GSM850/900
- $f_{VCO} = \frac{3}{4} f_{RX}$ for DCS1800 and PCS1900

For the transmitter VCO frequency, refer to the equations shown in Figure 6.

Digital Frequency Centering

The CX74063-26 uses a novel technique whereby the UHF VCO frequency range is re-centered each time the synthesizer is programmed. This technique is called Digital Frequency Centering (DFC). The DFC technique:

- Extends the VCO frequency coverage
- Speeds up settling time
- Ensures robust performance since the VCO is always operated at the center of its tuning range.

Each time the synthesizer is programmed, the DFC circuit is activated, and the VCO is centered to the programmed frequency in less than 20 μ s. After this, normal Phase Locked Loop (PLL) operation is resumed and the fine settling of the frequency is finalized. The DFC typically adjusts the VCO center frequency to within a few MHz and no more than 5 MHz offset, and presets the tuning voltage to the center of the range before the PLL takes over. This speeds up frequency settling and ensures that the PLL control voltage never operates close to the rails.

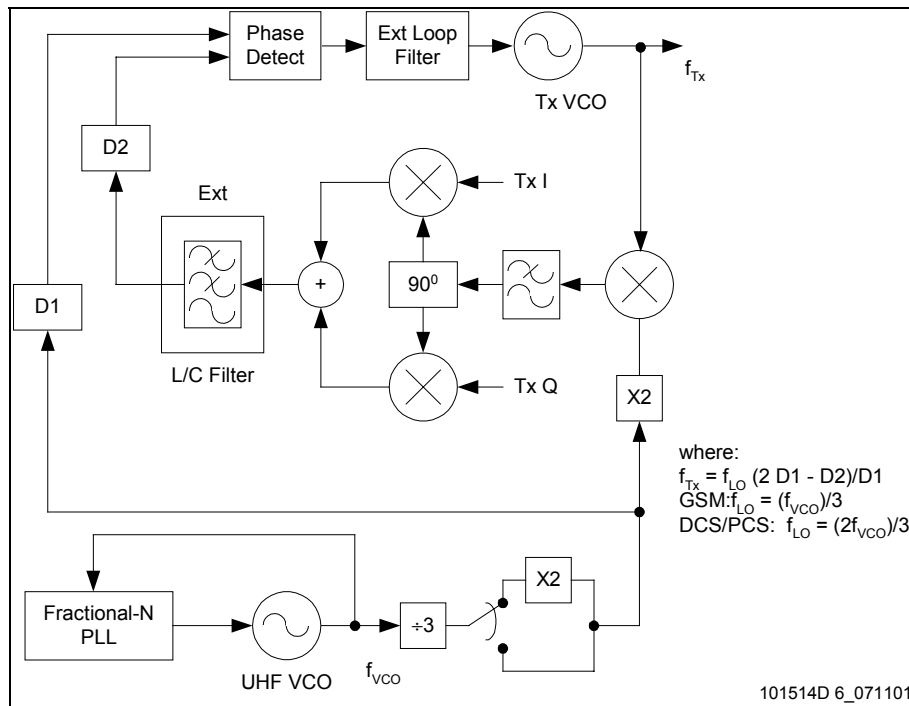

Figure 6. Transmitter Frequency Generation

The DFC is an adaptive circuit that corrects for any VCO center frequency errors caused by variations of the integrated VCO circuit, temperature, supply voltage, aging etc. The VCO can be centered at any frequency in the range from 1.2 GHz to 1.55 GHz. Once centered, the VCO has a minimum analog tuning range of 30 MHz.

No calibration or data storage is needed for DFC operation. It is activated by one of two events:

- When the synthesizer is programmed, the rising edge of the LE signal starts the DFC cycle and,
- When changing the level of the SXENA signal from low to high, thereby turning on the synthesizer, the rising edge of the SXENA signal starts the DFC cycle.

Crystal Oscillator

A crystal oscillator is designed to provide the reference frequency for the synthesizer. As shown in Figure 7, the oscillator uses an external crystal to generate an accurate oscillation frequency. The reference frequency can be changed through coarse tuning with an integrated capacitor array or fine tuning with the integrated varactor diode. The coarse tuning is done by switching in and out (using a digital word programmed via the serial interface) the capacitor network (CAP_A and CAP_B) located at the input of the integrated buffer. The fine tuning is done by providing a tuning voltage to the integrated varactor diode. Table 20 describes the control bits.

An output buffer is provided to drive the baseband circuitry (XTALBUF, pin 30). The VCXO and buffer circuitry are powered from pin 33 (VCCF). When VCCF is ramped to a voltage greater than 2.6 V, the output buffer powers on. The oscillator core powers up when pin 4 (VCXO_EN) is set to logic 1. If pin 4 is tied permanently to logic 1, the R6 VCXO Control Register is set to a defined state by a power-on reset. Pin 4 should be held low if an external reference oscillator is used. The buffer may be disabled by programming bit 3 in the SX1 Control Register (see Table 13) to logic 0.

Transmit Section

To minimize the post-PA filtering requirements and any additional post-PA losses, the transmit path consists of a vector modulator within a frequency translation loop. The translation loop consists of the following:

- Phase Frequency Detector (PFD) and charge pump
- Mixer with an operating range of 800 MHz to 2 GHz
- An in-loop modulator
- Two programmable dividers
- Two transmit VCOs

Translational Loop

The translational loop takes baseband analog I/Q signals and modulates them with the mixed product of transmitter output and LO signal, as shown in Figure 6. The unmodulated result is compared with a divided down LO at the PFD and the difference is used to control the transmit VCO. The on-chip Low Pass Filter (LPF) following the mixer attenuates the unwanted sidebands as well as harmonics.

Transmit VCOs

Two on-chip transmit VCOs are designed to meet GSM850, EGSM900, DCS1800, and PCS1900 requirements. The transmit VCOs use the same DFC technique as described in the Synthesizer section to lock the translational loop. The rising edge on TXENA initializes the transmit DFC.

Power Amplifier Gain Controller

The device contains an error amplifier/integrator to provide transmit burst control for an external power amplifier (PA). As shown in Figure 8, when the device is connected to a PA, an RF detector, and a coupler, a loop is formed that controls the transmit power in a multi-band wireless application. The error amplifier amplifies and integrates the voltage difference between the RF detector output (PDET) and the power control input (BBVAPC). The output of the integrator is fed to an internal gain shaper that drives the gain control input (PAVAPC) of the external RF PA. The device provides a bandgap voltage (PDETVCC) which can be used as the supply voltage for the external peak detector and can source up to 200 μ A.

The PA pre-bias is activated after a programmable delay and time-referenced from the rising edge of TXENA. The time delay is set using the serial interface. See Table 19 for details.

Digital Interface

The transceiver and synthesizer are controlled by a single three-wire serial interface. The transmitter, receiver, and synthesizer are each enabled through external inputs according to typical timing requirements as shown in Figures 10 and 11.

Band selection for the CX74063-26 is through the three-wire serial interface. The PCO signal (pin 3) provides a band selection control output. DC offset calibration and front-end activation timing can also be controlled by an on-chip signal sequencer, precluding the need for separate control signals. All the logic and the three-wire interface inputs are referenced to the PCO signal (pin 3).

The RX/TX Control Register is used to program the transceiver and to preset other test word states by setting bit 22 as a logic 1. If any test words are to be altered from their preset states, bit 22 must be sent to the RX/TX Control Register again as a logic 0. Typically, this is done only on power-up since the device has a zero-power standby mode that retains programmed test memory.

There are seven additional registers used to program various functions of the CX74063-26. The SX1 Control Register is used to program the fractional-N synthesizer and the SX2 Fractional-N Modulo Register is used to program the modulus. Three auxiliary registers are used to program the transceiver besides the RX/TX Control Register, and two 24-bit registers are used to program the synthesizer:

- SX1 Control
- SX2 Fractional-N Modulo
- RX/TX Control
- R0 Auxiliary Control

- R2 DC Offset Timing
- R3 IP2 Calibration
- R6 VCXO Control
- R7 VCXO Control

SX1 Control Register. This register is used to program the fractional-N synthesizer, and set the values of the integral-N divider and the input-R divider. The polarity of the Phase/Frequency Detector (PFD) may also be defined by this register. Refer to Table 13.

SX2 Fractional-N Modulo Register. This register is used to program the 24-bit modulo of the fractional-N synthesizer. The data is a 22-bit binary coded decimal word that allows the PLL to lock to precise frequencies. Refer to Table 14.

RX/TX Control Register. This register is used to control divide ratios and charge pump currents in the transmitter, and to control gain in the receiver along with the band select function. Refer to Table 15.

R0 Auxiliary Control Register. This register is used to bypass the DC offset correction loops and the baseband filters. It also enables and disables the two on-chip transmit VCOs and defines the directionality of the LO port, which allows an external VCO or LO reference to be used or enables the internal VCO to be monitored. Refer to Table 16.

R2 DC Offset Timing Register. This register sets the timing of the tracking of the three DC offset cancellation loops and the time at which the front end turns on relative to the RXENA signal (pin 1). It allows the front-end to be enabled using the internal timer. Refer to Table 17.

R3 IP2 Calibration Register. This register is used to perform 2nd order Intercept Point (IP2) calibration by manually adjusting calibration coefficients. A total of four words need to be set: IP2 coefficients for I-high band, I-low band, Q-high band, and Q-low band. Refer to Table 18.

The IP2 coefficient is eight bits long (including polarity) and is intended to be a factory calibration. An algorithm using a test tone needs to be used to determine the coefficient for each individual part.

R4 PAC Timing Control Register. This register is used to set timing for the PAC pedestal. See Table 19.

R6 and R7 VCXO Control Registers. These registers are used to control the tuning range and oscillation frequency of the VCXO. See Tables 20 and 21, respectively.

Electrical and Mechanical Specifications

The absolute maximum ratings of the CX74063-26 are provided in Table 3. The recommended operating conditions are specified in Table 4. Electrical specifications are provided in Tables 5 through 11. Tables 12 through 21, and Figures 9 through 11 provide the serial interface programming states, functions, and timing curves. Receiver data is shown in Tables 22 through 33 and illustrated in Figures 12 through 20. Transmit data is illustrated in Figures 21 through 26.

A typical application circuit using the CX74063-26 is shown in Figure 27. The 56-pin RFLGA package dimensions are provided in Figure 28 and the tape and reel dimensions are shown in Figure 29.

Electrostatic Discharge

The CX74063-26 contains Class 1 devices. The following Electrostatic Discharge (ESD) precautions are recommended:

- Protective outer garments
- Handle device in ESD safeguarded work area
- Transport device in ESD shielded containers
- Monitor and test all ESD protection equipment
- Treat the CX74063-26 as extremely sensitive to ESD

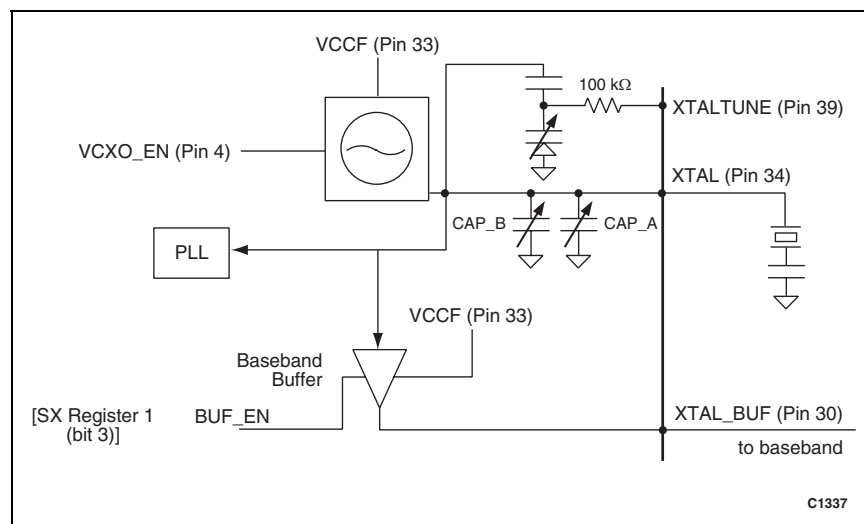

Figure 7. VCXO Block Diagram

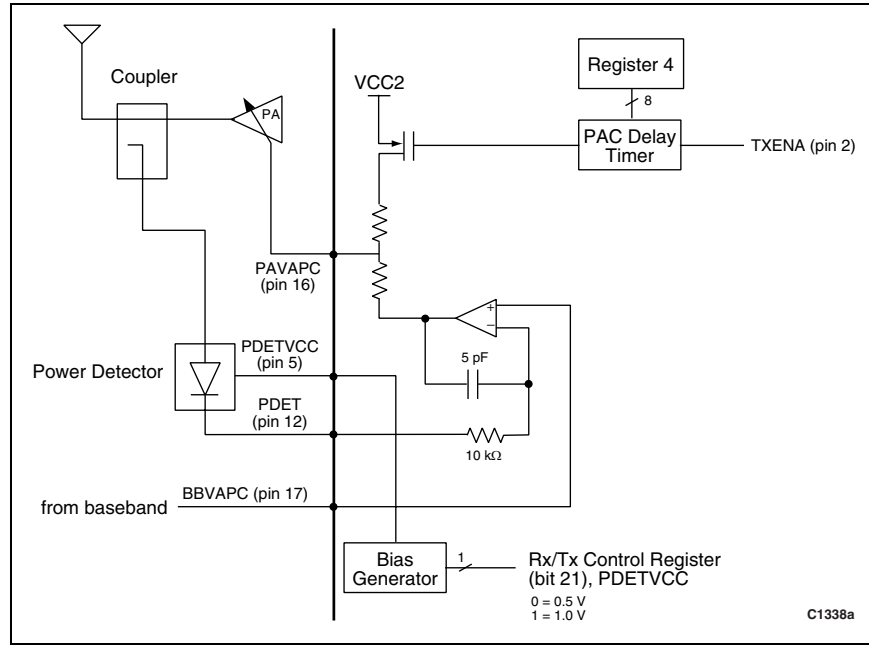

Figure 8. PA Controller Block Diagram

Table 3. CX74063-26 Absolute Maximum Ratings

Parameter	Minimum	Maximum	Units
Supply voltage (VCC)	-0.3	+3.6	V
Ambient operating temperature range	-40	+95	°C
Storage temperature range	-50	+125	°C
Input voltage range	GND	VCC	V
Maximum power dissipation		600	mW

Note: Stresses above these absolute maximum ratings may cause permanent damage. These are stress ratings only and functional operation at these conditions is not implied. Exposure to maximum rating conditions for extended periods may reduce device reliability.

Table 4. CX74063-26 Recommended Operating Conditions

Parameter	Minimum	Typical	Maximum	Units
LNA input level (pins 9, 11, 13) RXEN = Off			10	dBm
Power supply	2.6	2.8	3.3	V
Digital power supply, VDDBB	1.8		3.3	V
Operating junction temperature	-40		+110	°C
Operating ambient temperature	-30		+85	°C

Table 5. Power Consumption Specifications
 (TA = 25° C, VCC = 2.8 V unless otherwise noted)

Parameter	Symbol	Test Condition	Min	Typical	Max	Units
Total supply current:	I _{cc}					
Rx section, EGSM/GSM850		RXENA=H; SXENA=L		41	48	mA
Tx section, EGSM/GSM850 (includes TX VCO)		TXENA=H; SXENA=L		121	137	mA
Synthesizer section, EGSM/GSM850 (includes UHF VCO)		SXENA=H		39	46	mA
Rx section, DCS/PCS		RXENA=H; SXENA=L		49	58	mA
Tx section, DCS/PCS (includes TX VCO)		TXENA=H; SXENA=L		126	143	mA
Synthesizer section, DCS/PCS (includes UHF VCO)		SXENA=H		39	46	mA
Sleep mode		@ VCC = 3.3 V RXENA=L; TXENA=L; SXENA=L		20	100	μA

Table 6. CX74063-26 Electrical Specifications – EGSM/GSM850 Receiver (1 of 3)
 (T_A = 25° C, V_{CC} = 2.8 V unless otherwise noted)

Parameter	Symbol	Test Condition (Note 1)	Min	Typical	Max	Units
Input impedance. See Figure 12 for unmatched input impedance.	Z _{IN}	With external match		50		Ω
Input operating frequency	Band 1		869		960	MHz
Receiver maximum voltage gain	G _{RXMAX}	Highest gain mode	120	126		dB
Receiver minimum voltage gain	G _{RXMIN}	Lowest gain mode		11	17	dB
Receiver gain temperature variation	G _{TEMPVAR}	T _A = -30 °C to +85 °C			4.5	dB
Gain step	ΔA _V			2		dB
Gain step accuracy	G _{STEP}	Over range recommended in Table 25	-0.75		+0.75	dB
Gain variation versus frequency	G _{FREQ}	Over 869-894 MHz			2	dB
		Over 925-960 MHz			2	dB
Noise Figure	NF _{GAIN1}	G = 15/40/10/12/0/18		3.2	3.9	dB
Noise Figure (temperature)	NF _{TEMP}	T _A = +75 °C			5.0	dB
		T _A = +85 °C			5.2	dB
Noise Figure degradation in presence of blocker	NF _{BLOC}	With -26 dBm input blocker @ 3 MHz offset (ideal LO)			2	dB
		Internal LO			4	dB
		G = 15/40/10/12/0/18				
Input 2nd order intercept point	IIP2	Referred to LNA input calibrated and measured at middle of EGSM or GSM850 band.	50	65		dBm
DC shift in presence of blocker	AM Supp	With -34 dBm @ 6 MHz offset G = 15/40/10/12/0/18			17	mV
LO Re-radiation @ LNA input	LOREV	@ wanted frequency		-110	-100	dBm
Selectivity		@ 3 MHz offset	143			dB
		@ 1.6 MHz offset	128	137		dB
		@ 600 kHz offset	61	68		dB
		@ 400 kHz offset	37	44		dB
		@ 200 kHz offset	9	13		dB
		T _A = -30 °C to +85 °C				

Table 6. CX74063-26 Electrical Specifications – EGSM/GSM850 Receiver (2 of 3)
(TA = 25° C, VCC = 2.8 V unless otherwise noted)

Parameter	Symbol	Test Condition (Note 1)	Min	Typical	Max	Units
I/Q amplitude imbalance		TA = -30 °C to +85 °C			1	dB
I/Q phase imbalance		TA = -30 °C to +85 °C	-3		+3	degrees
Input 1 dB compression point	IP1dB	F = 200 kHz, G = 15/40/-2/8/0/18	-65	-60		dBm
		F = 400 kHz, G = 15/40/-2/8/0/18	-45	-40		dBm
		F = 600 kHz, G = 15/40/10/12/0/18	-35	-30		dBm
		F = 1.6 MHz, G = 15/40/10/12/0/18	-32	-28		dBm
		F = 3.0 MHz, G = 15/40/10/12/0/18	-25	-22		dBm
3rd order intercept point @ +25 °C	IIP3	F = 3.0 MHz G = 15/40/10/12/0/18	-15	-12		dBm
3rd order intercept point @ -20 °C	IIP3	F = 3.0 MHz G = 15/40/10/12/0/18	-15	-12		dBm
Output offset voltage		With DC offset corrected while LNA is off			200	mV
		TA = +85°C			220	mV
		With DC offset corrected while LNA is on G=15/40/10/12/0/18			20	mV
		TA = +85 °C (60 μs total DC correction time)			25	mV
Offset drift (long term)	DCDRFT1	G = 15/40/10/12/0/18 50 ms after correction			100	mV
Offset drift (short term)	DCDRFT2	G = 15/40/10/12/0/18 577 μs after correction			10	mV
Baseband Tunable Active Filter						
3 dB corner frequency (tunable)	Fc		80		100	kHz
Corner frequency variation	dFc	39.2 kΩ at pin 29 470 pF at pins 25-26 and 27-28	-11		+11	%

Table 6. CX74063-26 Electrical Specifications – EGSM/GSM850 Receiver (3 of 3)
(T_A = 25° C, VCC = 2.8 V unless otherwise noted)

Parameter	Symbol	Test Condition (Note 1)	Min	Typical	Max	Units
Receiver Output Stage						
Differential output amplitude (pk/pk differential)		VGA2 = 30 dB	3.7			V
		VGA2 = 0 dB	0.3			V
Output common mode voltage		T _A = -30 °C to +85 °C	VCC/2 – 0.1	VCC/2	VCC/2 + 0.1	V
Maximum current drive	I _{OUT}				0.5	mA
Output resistance	R _{OUT}		160	200	240	Ω
Output capacitance	C _{OUT}				1	pF

Note 1: Gain codes refer to LNA/Mixer/LPF1/VGA1/AUX/VGA2 gains in dB.

Table 7. CX74063-26 Electrical Specifications – DCS1800 Receiver (1 of 3)
(T_A = 25° C, VCC = 2.8 V unless otherwise noted)

Parameter	Symbol	Test Condition (Note 1)	Min	Typical	Max	Units
Input impedance See Figure 13 for unmatched input impedance.	Z _{IN}	With external match		50		Ω
Input operating frequency	Band 2	DCS Rx band	1805		1880	MHz
Receiver maximum voltage gain	G _{RXMAX}	Highest gain mode	117	123		dB
Receiver minimum voltage gain	G _{RXMIN}	Lowest gain mode		9	15	dB
Gain step	ΔA _V			2		dB
Receiver gain temperature variation	G _{TEMPVAR}	T _A = -30 °C to +85 °C			4.5	dB
Gain step accuracy	G _{STEP}	Over range recommended in Table 26	-0.75		+0.75	dB
Gain variation versus frequency	G _{FREQ}	Over band 2			2	dB
Noise Figure	NF _{GAIN1}	G = 15/40/10/12/0/18		3.6	4.3	dB
Noise Figure (temperature)	NF _{TEMP}	T _A = +75 °C T _A = +85 °C			5.4 5.6	dB
Noise Figure degradation in presence of blocker	NF _{BLOC}	With -30 dBm input blocker @ 3 MHz offset (ideal LO)		2		dB
		Internal LO G = 15/40/10/12/0/18		4		dB

Table 7. CX74063-26 Electrical Specifications – DCS1800 Receiver (2 of 3)
 (T_A = 25° C, VCC = 2.8 V unless otherwise noted)

Parameter	Symbol	Test Condition (Note 1)	Min	Typical	Max	Units
Input 2nd order intercept point	IIP2	Referred to LNA input calibrated and measured at middle of DCS1800 band.	50	65		dBm
DC shift in presence of blocker	AM Supp	With -33 dBm @ 6 MHz offset G = 15/40/10/12/0/18			17	mV
LO re-radiation @ LNA input	LOREV	@ wanted frequency		-110	-100	dBm
Selectivity		@ 3 MHz offset	143			dB
		@ 1.6 MHz offset	128	137		dB
		@ 600 kHz offset	61	68		dB
		@ 400 kHz offset	37	41		dB
		@ 200 kHz offset T _A = -30 °C to +85 °C	9	13		dB
I/Q amplitude imbalance		T _A = -30 °C to +85 °C			1	dB
I/Q phase imbalance		T _A = -30 °C to +85 °C	-3		+3	degrees
Input 1 dB compression point	IP1dB	F = 200 kHz, G = 15/40/-2/8/0/18	-65	-60		dBm
		F = 400 kHz, G = 15/40/-2/8/0/18	-45	-40		dBm
		F = 600 kHz, G = 15/40/10/12/0/18	-35	-30		dBm
		F = 1.6 MHz, G = 15/40/10/12/0/18	-32	-28		dBm
		F = 3.0 MHz, G = 15/40/10/12/0/18	-25	-22		dBm
3rd order intercept point @ +25 °C	IIP3	F = 3.0 MHz G = 15/40/10/12/0/18	-15	-12		dBm
3rd order intercept point @ -20 °C	IIP3	F = 3.0 MHz G = 15/40/10/12/0/18	-15	-12		dBm

Table 7. CX74063-26 Electrical Specifications – DCS1800 Receiver (3 of 3)
(T_A = 25° C, VCC = 2.8 V unless otherwise noted)

Parameter	Symbol	Test Condition (Note 1)	Min	Typical	Max	Units
Output offset voltage		With DC offset corrected while LNA is off T _A = + 85°C			200	mV
					220	mV
		With DC offset corrected while LNA is on G=15/40/10/12/0/18 T _A = + 85 °C (60 μs total DC correction time)			20	mV
					25	mV
Offset drift (long term)	DCDRFT1	G=15/40/10/12/0/18 50 ms after correction			100	mV
Offset drift (short term)	DCDRFT2	G=15/40/10/12/0/18 577 μs after correction			10	mV
Baseband Tunable Active Filter						
3 dB corner frequency (tunable)	F _c		80		100	kHz
Corner frequency variation	dF _c	39.2 kΩ at pin 29 470 pF at pins 25-26 and 27-28	-11		+11	%
Receiver Output Stage						
Differential output amplitude (pk/pk differential)		VGA2 = 30 dB	3.7			V
		VGA2 = 0 dB	0.3			V
Output common mode voltage			VCC/2 – 0.1	VCC/2	VCC/2 + 0.1	V
Maximum current drive	I _{OUT}				0.5	mA
Output Resistance	R _{OUT}		160	200	240	Ω
Output Capacitance	C _{OUT}				1	pF

Note 1: Gain codes refer to LNA/Mixer/LPF1/VGA1/AUX/VGA2 gains in dB.

Table 8. CX74063-26 Electrical Specifications – PCS1900 Receiver (1 of 3)
 (TA = 25 °C, VCC = 2.8 V unless otherwise noted)

Parameter	Symbol	Test Condition (Note 1)	Min	Typical	Max	Units
Input impedance. See Figure 14 for unmatched input impedance.	Z _{IN}	With external match		50		Ω
Input operating frequency	Band 3	PCS Rx band	1930		1990	MHz
Receiver maximum voltage gain	G _{RXMAX}	Highest gain mode	117	123		dB
Receiver minimum voltage gain	G _{RXMIN}	Lowest gain mode		7	13	dB
Receiver gain temperature variation	G _{TEMPVAR}	T _A = -30 °C to +85 °C			4.5	dB
Gain step	ΔA _V			2		dB
Gain step accuracy	G _{STEP}	Over range recommended in Table 27	-0.75		+0.75	dB
Gain variation versus frequency	G _{FREQ}	Over band 3			2	dB
Noise Figure	NF _{GAIN1}	G = 15/40/10/14/0/18		4.2	4.9	dB
Noise Figure (temperature)	NF _{TEMP}	T _A = +75 °C T _A = +85 °C			6.0 6.2	dB
Noise Figure degradation in presence of blocker	NF _{BLOC}	With -30 dBm input blocker @ 3MHz offset (ideal LO) Internal LO G = 15/40/10/14/0/18		2 4		dB dB
Input 2nd order intercept point	IIP2	Referred to LNA input calibrated and measured at middle of PCS1900 band	50	65		dBm
DC shift in presence of blocker	AM Supp	With -33 dBm @ 6 MHz offset G = 15/40/10/14/0/18			17	mV
LO Re-radiation @ LNA input	LOREV	@ wanted frequency		-110	-100	dBm
Selectivity		@ 3 MHz offset @ 1.6 MHz offset @ 600 kHz offset @ 400 kHz offset @ 200 kHz offset T _A = -30 °C to +85 °C	143 128 61 37 9			dB dB dB dB dB
I/Q amplitude imbalance		T _A = -30 °C to +85 °C			1	dB
I/Q phase imbalance		T _A = -30 °C to +85 °C	-3		+3	degrees

Table 8. CX74063-26 Electrical Specifications – PCS1900 Receiver (2 of 3)
(T_A = 25 °C, VCC = 2.8 V unless otherwise noted)

Parameter	Symbol	Test Condition (Note 1)	Min	Typical	Max	Units
Input 1 dB compression point	IP1dB	F = 200 kHz, G = 15/40/-2/8/0/18	-65	-60		dBm
		F = 400 kHz, G = 15/40/-2/8/0/18	-45	-40		dBm
		F = 600 kHz, G = 15/40/10/14/0/18	-35	-30		dBm
		F = 1.6 MHz, G = 15/40/10/14/0/18	-32	-28		dBm
		F = 3.0 MHz, G = 15/40/10/14/0/18	-25	-22		dBm
3rd order intercept point @ +25 °C	IIP3	F = 3.0 MHz G = 15/40/10/14/0/18	-15	-12		dBm
3rd order intercept point @ -20 °C	IIP3	F = 3.0 MHz G = 15/40/10/14/0/18	-15	-12		dBm
Output offset voltage		With DC offset corrected while LNA is off			200	mV
		T _A = + 85°C			220	mV
		With DC offset corrected while LNA is on			20	mV
		G = 15/40/10/12/0/18 T _A = + 85 °C (60 μs total DC correction time)			25	mV
Offset drift (long term)	DCDRFT1	50 ms after correction G = 15/40/10/14/0/18			100	mV
Offset drift (short term)	DCDRFT2	577 μs after correction G = 15/40/10/14/0/18			10	mV
Baseband Tunable Active Filter						
3 dB corner frequency (tunable)	F _c		80		100	kHz
Corner frequency variation	dF _c	39.2 kΩ at pin 29 470 pF at pins 25-26 and 27-28	-11		+11	%

Table 8. CX74063-26 Electrical Specifications – PCS1900 Receiver (3 of 3)
 (T_A = 25° C, VCC = 2.8 V unless otherwise noted)

Parameter	Symbol	Test Condition (Note 1)	Min	Typical	Max	Units
Receiver Output Stage						
Differential output amplitude (pk/pk differential)		VGA2 = 30 dB	3.7			V
		VGA2 = 0 dB	0.3			V
Output common mode voltage			VCC/2 – 0.1	VCC/2	VCC/2 + 0.1	V
Maximum current drive	I _{OUT}				0.5	mA
Output resistance	R _{OUT}		160	200	240	Ω
Output capacitance	C _{OUT}				1	pF

Note 1: Gain codes refer to LNA/Mixer/LPF1/VGA1/AUX/VGA2 gains in dB.

Table 9. CX74063-26 Electrical Specifications – Transmitter (1 of 4)
 (T_A = 25° C, VCC = 2.8 V unless otherwise noted)

Parameter	Symbol	Test Condition	Min	Typical	Max	Units
I/Q Modulator						
Differential input impedance	Z _{IN}		16	20	24	kΩ
Input signal level		Differential	0.8	1	1.2	V _{p-p}
Input common mode voltage range	V _{CM}		0.85	1.35	VCC – 1.3	V
Input frequency 3 dB bandwidth				3		MHz
Input common mode rejection ratio		f _{IN} = 100 kHz	65	75		dB
		f _{IN} = 1 MHz	45	55		
Output operating frequency	F _{OUT}		70		130	MHz
Output impedance	Z _{OUT}	Per side	170	200	230	Ω
Output voltage	V _{OUT}			–33		dBV
Output noise power	N _O	@ 10 MHz offset		–132	–128	dBc/Hz
		@ 1.8 MHz offset		–130	–126	dBc/Hz
LO suppression			30	35		dBc
Sideband suppression			30	35		dBc
Translational Loop						
Spurious		Modulation 2nd order		–70	–40	dBc
		Modulation 3rd order		–60	–55	dBc
Transmit frequency (input from VCO)	F _{TX}		800		2000	MHz
IF frequency	F _{IF}		70		130	MHz
Transmit input power	P _{IN}	With external 50 Ω termination	–20	–15	–10	dBm

Table 9. CX74063-26 Electrical Specifications – Transmitter (2 of 4)
 (T_A = 25° C, V_{CC} = 2.8 V unless otherwise noted)

Parameter	Symbol	Test Condition	Min	Typical	Max	Units
Translational Loop (continued)						
Transmit input impedance	Z _{IN}			300// 0.3		Ω// pF
Transmitter output phase noise (includes TX VCO and LO PLL)	N ₀	@ 400 kHz offset		-120	-118	dBc/Hz
		@ 1.8 MHz offset		-130	-124	dBc/Hz
		@ 10 MHz offset EGSM/GSM850		-152	-150	dBc/Hz
		@ 20 MHz offset EGSM/GSM850		-164	-162	dBc/Hz
		@ 20 MHz offset DCS/PCS		-156	-154	dBc/Hz
Tx phase error	T _{XPHERR}	rms (employs reference frequency source, and loop filters as shown in the reference design)		2.0		degrees
Charge pump output current: high impedance source/sink	I _{OUT}	RX/TX control register bits S15 S14 CP = 0 0 CP = 0 1 CP = 1 0 CP = 1 1		±0.5 ±0.75 ±1.0 ±1.25		mA mA mA mA
Charge pump current variation		0.3 ≤ V _{CPO} ≤ V _{CC} - 0.5			20	%
Charge pump current variation over temperature		0.3 ≤ V _{CPO} ≤ V _{CC} - 0.5 T _A = -30 °C to +85 °C		10		%
D1 divide ratio range			9		12	
D2 divide ratio			1		2	
Tx mixer LO leakage	TX MIX LEAKAGE	Tx mixer 50 Ω terminated			-60	dBm
Low Band Translation Loop VCO						
Center frequency	f _c	T _A = -30 °C to +85 °C	800		930	MHz
Digital frequency centering resolution	e _{DFC}			2.5		MHz
Digital frequency centering time	t _{DFC}	From rising edge of TXENA (13 MHz clock frequency)		12	20	μs
Digital frequency centering voltage	V _{DFC}	(Control voltage at end of DFC and start of analog lock)	V _{CC} /2 - 0.2	V _{CC} /2	V _{CC} /2 + 0.2	V
Analog frequency control range	f _{MAX} - f _{MIN}	0.5 < V _{CTL} < 2.2	20			MHz

Table 9. CX74063-26 Electrical Specifications – Transmitter (3 of 4)
 (T_A = 25° C, VCC = 2.8 V unless otherwise noted)

Parameter	Symbol	Test Condition	Min	Typical	Max	Units
Low Band Translation Loop VCO (continued)						
Absolute control sensitivity	K _{VCO}	(0.9 V < V _{CTL} and 1.9 V > V _{CTL})				
		820 MHz < f _c < 850 MHz	16	21	26	MHz/V
		870 MHz < f _c < 915 MHz	18	25	32	MHz/V
Output harmonics		2nd harmonic		-50	-30	dBc
		3rd harmonic		-55	-30	dBc
Phase noise		@ 400 kHz offset		-125.0	-120.0	dBc/Hz
		@ 20 MHz offset		-164.0	-162.0	dBc/Hz
		@ 30 MHz offset			-164.5	dBc/Hz
Output VSWR		with external 50 Ω match			2:1	
Pushing				2	4	MHz/V
Pulling		VSWR 2:1			±4	MHz
Output power	P _{OUT}	F _{OUT} = 897.5 MHz with external 50 Ω match	10.5	11.5	12.5	dBm
Output power temperature variation		T _A = -30°C to +85°C		±0.7		dB
High Band Translation Loop VCO						
Center frequency	f _c	T _A = -30 °C to +85 °C	1700		1930	MHz
Digital frequency centering resolution	e _{DFC}			6		MHz
Digital frequency centering time	t _{DFC}	From rising edge of TXENA(13 MHz clock frequency)		12	20	μs
Digital frequency centering voltage	V _{DFC}	control voltage at end of DFC and start of analog lock	VCC/2 - 0.2	VCC/2	VCC/2 + 0.2	V
Analog frequency control range	f _{MAX} - f _{MIN}	0.5 < V _{CTL} < 2.2	20			MHz
Absolute control sensitivity	K _{VCO}	0.9 V < V _{CTL} and 1.9 V > V _{CTL}				
		1710 MHz < f _c < 1785 MHz	14	18	22	MHz/V
		1850 MHz < f _c < 1910 MHz	19	23	27	MHz/V
Output harmonics		2nd harmonic		-50	-30	dBc
		3rd harmonic		-55	-30	dBc

Table 9. CX74063-26 Electrical Specifications – Transmitter (4 of 4)
 (T_A = 25° C, V_{CC} = 2.8 V unless otherwise noted)

Parameter	Symbol	Test Condition	Min	Typical	Max	Units
High Band Translation Loop VCO (continued)						
Phase noise		@ 400 kHz offset		-125.0	-120.0	dBc/Hz
		@ 20 MHz offset		-158.0	-155.0	dBc/Hz
		@ 30 MHz offset			-164.5	dBc/Hz
Output VSWR		with external 50 Ω match			2:1	
Pushing				2	4	MHz/V
Pulling		VSWR 2:1			±4	MHz
Output power	P _{OUT}	F _{OUT} = 1747.5 MHz with external 50 Ω match	5.5	7	8.5	dBm
Output power variation		T _A = -30 °C to +85 °C		±1		dB
PA Gain Controller						
PAVAPC output swing			0.22		V _{CC} – 0.3	V
PAVAPC offset voltage		TXENA = H		0.68		
PAVAPC sink current	I _{SINK}			550		μA
PAVAPC source current	I _{SOURCE}			750		μA
Open loop gain	G		104		111	dB
Input common mode range			0		2.7	V
PDETVCC source current	I _{PDETVCC}			200		μA
PDETVCC output voltage		PDETVCC = 0 (bit 21 of RX/TX Control Register)		0.5		V
		PDETVCC = 1 (bit 21 of RX/TX Control Register)		1.0		V
Output load				10pF 10 kΩ		

Table 10. CX74063-26 Electrical Specifications – Synthesizer (1 of 3)
 (T_A = 25° C, V_{CC} = 2.8 V unless otherwise noted)

Parameter	Symbol	Test Condition	Min	Typical	Max	Units
Prescaler operating input frequency			1000		1700	MHz
Reference input frequency			10	13	26	MHz
Phase detector frequency				13	15	MHz
External crystal oscillator input sensitivity			-15		+3	dBm
Reference oscillator sensitivity			0.4		V _{CC}	V _{PEAK}
In-band phase noise		Measured within the loop bandwidth		-85		dBc/Hz
Charge pump output current (can be programmed in four steps)		V _{CP} = V _{CCFN_CP} /2 (SX1 Control Register, bit[6:5] = 00)		100		μA
		V _{CP} = V _{CCFN_CP} /2 (SX1 Control Register, bit[6:5] = 01)		200		μA
		V _{CP} = V _{CCFN_CP} /2 (SX1 Control Register, bit[6:5] = 10)		300		μA
		V _{CP} = V _{CCFN_CP} /2 (SX1 Control Register, bit[6:5] = 11)		400		μA
Charge pump leakage current		0.5 < V _{CP} < V _{CCFN_CP} - 0.5		0.1		nA
Charge pump sink versus source mismatch		V _{CP} = V _{CCFN_CP} /2		5		%
Charge pump current versus voltage		0.5 < V _{CP} < V _{CCFN_CP} - 0.5		10		%
Charge pump current versus temperature		V _{CP} = V _{CCFN_CP} /2 T _A = -30 °C to +85 °C		10		%
UHF VCO						
Center frequency	f _c	T _A = -30 °C to +85 °C	1200		1550	MHz
Digital frequency centering resolution	e _{DFC}			2		MHz
Digital frequency centering time	t _{DFC}	From rising edge of SXENA or LE when programming SX word (13 MHz clock frequency)		12	20	μs
Digital frequency centering voltage	V _{DFC}	control voltage at end of DFC/start of analog lock	V _{CCUHF} /2 - 0.2	V _{CCUHF} /2	V _{CCUHF} /2 + 0.2	V
Analog frequency control range	f _{MAX} - f _{MIN}	0.5 < V _{CTL} < 2.2	30			MHz

Table 10. CX74063-26 Electrical Specifications – Synthesizer (2 of 3)
(T_A = 25° C, V_{CC} = 2.8 V unless otherwise noted)

Parameter	Symbol	Test Condition	Min	Typical	Max	Units
UHF VCO (continued)						
Relative control sensitivity	K _{VCO} /f _c	After DFC, within the range of e _{VCTL}				
		1200 MHz < f _c < 1300 MHz	1.3	1.7	2.1	%/V
		1300 MHz < f _c < 1400 MHz	1.5	2.0	2.4	%/V
		1400 MHz < f _c < 1475 MHz	1.7	2.2	2.6	%/V
		1475 MHz < f _c < 1550 MHz	1.9	2.4	2.8	%/V
Absolute control sensitivity	K _{VCO}	V _{DFC} + e _{VCTL,MIN} < V _{CTL} and V _{DFC} + e _{VCTL,MAX} > V _{CTL}				
		1200 MHz < f _c < 1300 MHz	15	21	28	MHz/V
		1300 MHz < f _c < 1400 MHz	19	27	34	MHz/V
		1400 MHz < f _c < 1475 MHz	24	32	39	MHz/V
		1475 MHz < f _c < 1550 MHz	28	36	44	MHz/V
Phase noise		@ 400 kHz offset		-123	-121	dBc/Hz
		@ 3 MHz offset		-140	-137	dBc/Hz
Slow center frequency drift	Δf _c /Δt	T _A = -30°C to + 85°C	-5		+5	MHz/sec
26 MHz Crystal Oscillator						
Operating frequency				26		MHz
Buffer output frequency				26		MHz
Phase noise:						
@ 100 Hz					-98	dBc/Hz
@ 1 kHz					-127	dBc/Hz
@ 10 kHz					-145	dBc/Hz
Clock jitter					16	ps
Spurious rejection				-20	-15	dBc
Digital tuning (Note 1)			±50	±70		ppm
Analog tuning (Note 1)		V _{TUNE} = 0.05 to 2.5 V	±20	±23		ppm
Analog varactor voltage range			0		V _{CC}	V
Analog varactor DC impedance				1		MΩ
Supply voltage dependence		2.8 ± 0.1 V		1	2	ppm/V
Operating current (start) @ 26 MHz				2600		μA

Table 10. CX74063-26 Electrical Specifications – Synthesizer (3 of 3)
(T_A = 25° C, VCC = 2.8 V unless otherwise noted)

Parameter	Symbol	Test Condition	Min	Typical	Max	Units
26 MHz Crystal Oscillator (continued)						
Operating current (equilibrium) @ 26 MHz				2600		μA
Voltage swing @ crystal				1.1		V _{pp}
Voltage swing @ buffer			0.8	1.1		V _{pp}
Buffer output load				10pF 10 kΩ		
Start-up time					4	ms
Tuning sensitivity					35	ppm/V

Note 1: Using a crystal with equivalent 6 mH inductor and ESR ≤ 100 Ω.

Table 11. CX74063-26 Electrical Specifications – Digital Interface
(T_A = 25° C, VCC = 2.8 V unless otherwise noted)

Parameter	Symbol	Test Condition	Min	Typical	Max	Units
Data to clock setup time (Note 1)	T _{CS}		30			ns
Data to clock hold time (Note 1)	T _{CH}		10			ns
Clock pulse width high (Note 1)	T _{CWH}		30			ns
Clock pulse width low (Note 1)	T _{CWL}		30			ns
Clock to load enable setup time (Note 1)	T _{ES}		30			ns
Load enable pulse width (Note 1)	T _{EW}		50			ns
LE falling edge to clock rising edge (Note 1)	T _{EFC}		30			ns
RXENA setup time TXENA setup time SXENA setup time			30 30 30			ns ns ns
High level input voltage	V _{IH}	RXENA, TXENA, DATA, CLK, LE, PCO, VCXO_EN, SXENA	0.8 × VDDBB			V
Low level input voltage	V _{IL}				0.2 × VDDBB	V
High level input current	I _{IH}		-1		+1	μA
Low level input current	I _{IL}		-1		+1	μA
Digital input pin capacitance	C _{ID}				10	pF
High level output voltage	V _{OH}		PCO, I _{OH} = -1.0 mA	VDDBB - 0.4		
Low level output voltage	V _{OL}	PCO, I _{OL} = 1.0 mA			0.4	V
Digital output pin load capacitance	C _{LD}	PCO			15	pF

Note 1: See Figure 9.

Serial Interface Programming

Table 12. Control and Output States

Register	Address Bits						
	B6	B5	B4	B3	B2	B1	B0
SX1 Control	X	X	X	X	X	0	0
SX2 Fractional-N Modulo	X	X	X	X	X	1	0
RX/TX Control	X	X	X	X	X	1	1
R0 Auxiliary Control	X	X	X	0	0	0	1
R2 DC Offset Timing	X	X	X	1	0	0	1
R3 IP2 Calibration	X	0	0	1	1	0	1
R4 PAC Timing Control	X	0	1	1	1	0	1
R6 VCXO Control	0	1	0	1	1	0	1
R7 VCXO Control	1	1	0	1	1	0	1

Table 13. SX1 Control Register (Synthesizer Control Functions)

Symbol	Function	State Description
ADDR	Address bits [1:0]. Must be set to 00b (see Table 12)	
EN	Enable mode [2]	0 enables synthesizer 1 disables synthesizer
BUF_EN	Buffer enable [3]	0 sets buffer to off state 1 sets buffer to on state
SP	Phase detector output polarity [4]	0 sets phase detector output for negative VCO gain 1 sets phase detector output for positive VCO gain
SC	Charge pump output current [6:5]	Bit [6,5]: 0 0 sets charge pump current to 100 μ A 0 1 sets charge pump current to 200 μ A 1 0 sets charge pump current to 300 μ A 1 1 sets charge pump current to 400 μ A
RSVD	Reserved	Bit [8,7]: set bit 8 = 1, bit 7 = 0
N	Main divider [19:9]	Sets 11-bit main divider ratio range (64...2047)
R	Reference divider [23:20]	Sets 4-bit reference divider ratio range (1...15)

Table 14. SX2 Fractional-N Modulo Register

Symbol	Function	State Description
ADDR	Address bits [1:0]. Must be set to 10b (see Table 12)	
FN	Fractional-N modulo [23:2]	Sets fractional-N modulo up to 2 ²² range (0...4,194,303)

Table 15. RX/TX Control Register (1 of 2)

Symbol	Function	State Description																																
ADDR	Address bits [1:0]. Must be set to 11b (see Table 12)																																	
LNA	LNA gain step control [2]	0 selects low gain mode of LNA 1 selects high gain mode of LNA																																
MIX	Mixer gain step [3]	0 selects low gain mode of RX mixer 1 selects high gain mode of RX mixer																																
LPF1	1st LPF gain step [4]	0 selects low gain mode of the first active LPF 1 selects high gain mode of the first active LPF																																
VGA2	VGA2 gain steps [7:5]	Bit 7 to bit 5 program the VGA2 gain in 6 dB increments: Bit 7, Bit 6, Bit 5 <table border="0" style="margin-left: 20px;"> <tr><td>0</td><td>0</td><td>0</td><td>sets the gain to 30 dB</td></tr> <tr><td>0</td><td>0</td><td>1</td><td>sets the gain to 24 dB</td></tr> <tr><td>0</td><td>1</td><td>0</td><td>sets the gain to 18 dB</td></tr> <tr><td>0</td><td>1</td><td>1</td><td>sets the gain to 12 dB</td></tr> <tr><td>1</td><td>0</td><td>0</td><td>sets the gain to 6 dB</td></tr> <tr><td>1</td><td>0</td><td>1</td><td>sets the gain to 0 dB</td></tr> <tr><td>1</td><td>1</td><td>0</td><td>not used</td></tr> <tr><td>1</td><td>1</td><td>1</td><td>not used</td></tr> </table>	0	0	0	sets the gain to 30 dB	0	0	1	sets the gain to 24 dB	0	1	0	sets the gain to 18 dB	0	1	1	sets the gain to 12 dB	1	0	0	sets the gain to 6 dB	1	0	1	sets the gain to 0 dB	1	1	0	not used	1	1	1	not used
0	0	0	sets the gain to 30 dB																															
0	0	1	sets the gain to 24 dB																															
0	1	0	sets the gain to 18 dB																															
0	1	1	sets the gain to 12 dB																															
1	0	0	sets the gain to 6 dB																															
1	0	1	sets the gain to 0 dB																															
1	1	0	not used																															
1	1	1	not used																															
AUX	Auxiliary gain [8]	0 sets 0 dB auxiliary gain post gmC filter 1 sets 6 dB auxiliary gain post gmC filter																																
VGA1	VGA1 gain steps [11:9]	Bit 11 to bit 9 program the VGA1 gain in the following increments: Bit 11, Bit 10, Bit 9 <table border="0" style="margin-left: 20px;"> <tr><td>0</td><td>0</td><td>0</td><td>sets the gain to 0 dB</td></tr> <tr><td>0</td><td>0</td><td>1</td><td>sets the gain to 24 dB</td></tr> <tr><td>0</td><td>1</td><td>0</td><td>sets the gain to 12 dB</td></tr> <tr><td>0</td><td>1</td><td>1</td><td>not used</td></tr> <tr><td>1</td><td>0</td><td>0</td><td>sets the gain to 6 dB</td></tr> <tr><td>1</td><td>0</td><td>1</td><td>sets the gain to 30 dB</td></tr> <tr><td>1</td><td>1</td><td>0</td><td>sets the gain to 18 dB</td></tr> <tr><td>1</td><td>1</td><td>1</td><td>not used</td></tr> </table>	0	0	0	sets the gain to 0 dB	0	0	1	sets the gain to 24 dB	0	1	0	sets the gain to 12 dB	0	1	1	not used	1	0	0	sets the gain to 6 dB	1	0	1	sets the gain to 30 dB	1	1	0	sets the gain to 18 dB	1	1	1	not used
0	0	0	sets the gain to 0 dB																															
0	0	1	sets the gain to 24 dB																															
0	1	0	sets the gain to 12 dB																															
0	1	1	not used																															
1	0	0	sets the gain to 6 dB																															
1	0	1	sets the gain to 30 dB																															
1	1	0	sets the gain to 18 dB																															
1	1	1	not used																															
VGA1FINE	VGA1 fine gain step [13:12]	Bit 13 and bit 12 program VGA1 in 2 dB increments: Bit 13, Bit 12 <table border="0" style="margin-left: 20px;"> <tr><td>0</td><td>0</td><td>sets gain to 0 dB</td></tr> <tr><td>0</td><td>1</td><td>sets gain to 4 dB</td></tr> <tr><td>1</td><td>0</td><td>sets gain to 2 dB</td></tr> <tr><td>1</td><td>1</td><td>not used</td></tr> </table>	0	0	sets gain to 0 dB	0	1	sets gain to 4 dB	1	0	sets gain to 2 dB	1	1	not used																				
0	0	sets gain to 0 dB																																
0	1	sets gain to 4 dB																																
1	0	sets gain to 2 dB																																
1	1	not used																																

Table 15. RX/TX Control Register (2 of 2)

Symbol	Function	State Description												
TXCP	TX charge pump bits [15:14]	Translational loop charge pump current setting: Bit 15, Bit 14 <table border="0"> <tr> <td>0</td> <td>0</td> <td>sets TXCP to 0.5 mA</td> </tr> <tr> <td>0</td> <td>1</td> <td>sets TXCP to 0.75 mA</td> </tr> <tr> <td>1</td> <td>0</td> <td>sets TXCP to 1.0 mA</td> </tr> <tr> <td>1</td> <td>1</td> <td>sets TXCP to 1.25 mA</td> </tr> </table>	0	0	sets TXCP to 0.5 mA	0	1	sets TXCP to 0.75 mA	1	0	sets TXCP to 1.0 mA	1	1	sets TXCP to 1.25 mA
0	0	sets TXCP to 0.5 mA												
0	1	sets TXCP to 0.75 mA												
1	0	sets TXCP to 1.0 mA												
1	1	sets TXCP to 1.25 mA												
TXD1	TX divider D1 [17:16]	Translational loop D1 divider setting: Bit 17, Bit 16 <table border="0"> <tr> <td>0</td> <td>0</td> <td>sets D1 to 9</td> </tr> <tr> <td>0</td> <td>1</td> <td>sets D1 to 11</td> </tr> <tr> <td>1</td> <td>0</td> <td>sets D1 to 10</td> </tr> <tr> <td>1</td> <td>1</td> <td>sets D1 to 12</td> </tr> </table>	0	0	sets D1 to 9	0	1	sets D1 to 11	1	0	sets D1 to 10	1	1	sets D1 to 12
0	0	sets D1 to 9												
0	1	sets D1 to 11												
1	0	sets D1 to 10												
1	1	sets D1 to 12												
TXD2	TX divider D2 [18]	Translational loop D2 divider setting: 0 sets D2 to 1 1 sets D2 to 2												
PDETVCC	Power detector bias [19]	Bit [19] sets bias voltage for the Schottky diode pair: 0 = 0.5 V 1 = 1.0 V												
SOFTSEL	Software band select [21:20]	Bit 21, Bit 20 <table border="0"> <tr> <td>0</td> <td>0</td> <td>not used</td> </tr> <tr> <td>0</td> <td>1</td> <td>selects EGSM/GSM850, PCO = 0</td> </tr> <tr> <td>1</td> <td>0</td> <td>selects DCS, PCO = 1</td> </tr> <tr> <td>1</td> <td>1</td> <td>selects PCS, PCO = 1</td> </tr> </table>	0	0	not used	0	1	selects EGSM/GSM850, PCO = 0	1	0	selects DCS, PCO = 1	1	1	selects PCS, PCO = 1
0	0	not used												
0	1	selects EGSM/GSM850, PCO = 0												
1	0	selects DCS, PCO = 1												
1	1	selects PCS, PCO = 1												
PREENA	Load default words [22]	0 allows changing contents of R0 to R7 1 allows loading default words into R0 to R7 Upon power up, program RX/TX control register with PREENA = 1 to load the default words into R0 to R5. If changing the default words is required, program RX/TX control register with PREENA = 0 and then program any or all of R0 to R5. PREENA should also be set to 0 when sending SX R1, SX R2, and RX/TX control register words before each time slot in normal operation. The data is stored in R0 to R5 as long as VDDBB (pin 43) is supplied with power.												
NU	Not used [23]	Not used												

Table 16. R0 Auxiliary Control Register

Symbol	Function	State Description	Default (Binary)
ADDR	Address bits [3:0]. Must be set to 0001b (see Table 12)		
GMC_BYP	Bypass GMC stage [4]	0 enables gmC filter stage 1 disables and bypasses gmC filter stage	0
SK_BYP	Bypass S-K stage [5]	0 enables Sallen-Key filter stage 1 disables and bypasses Sallen-Key filter stage	0
DC_BYP1	Bypass first DC OC loop [6]	0 enables first DC offset correction loop 1 disables and bypasses first DC offset correction loop	0
DC_BYP2	Bypass second DC OC loop [7]	0 enables second DC offset correction loop 1 disables and bypasses second DC offset correction	0
DC_BYP3	Bypass second DC OC loop [8]	0 enables third DC offset correction loop 1 disables and bypasses third DC offset correction	0
NU	Not used [9]	Not used	0
TXVCOEN	TXVCO Select [10]	0 disables TXVCO 1 enables TXVCO via TXENA (Pin4)	1
RSVD	Reserved [12:11]	Reserved, must be programmed to default value	10
NU	Not Used [13]	Not Used	0
RSVD	Reserved [14]	Reserved, must be programmed to default value	0
RSVD	Reserved [15]	Reserved, must be programmed to default value	0
DFCPLLENA	DFC Enable [16]	0 disables DFC 1 enables DFC	1
UHFVCOENA	UHFVCO Enable [17]	0 disables internal UHF VCO 1 enables internal UHF VCO	1
RSVD	Reserved[20:18]	Reserved, must be programmed to default value	011
CALENA	Enable IP2 Cal [21]	0 disables IP2 calibration 1 enables IP2 calibration	1
NU	Not used[22]	Not used	0
NU	Not used[23]	Not used	0

Table 17. R2 DC Offset Timing Register

Symbol	Function	State Description	Default (Binary)
ADDR	Address bits [3:0]. Must be set to 1001b (see Table 12)		
DCOCL1	DCOC control [7:4]	Tracking timing for DCOCL1 ($tT_H1 = (DCOCL1 \times 64 \times R)/F_{ref}$) (Note 1)	0100 (20 μ s with 13 MHz f_{REF})
DCOCL2	DCOC control [12:8]	Tracking timing for DCOCL2 ($tT_H2 = (DCOCL2 \times 64 \times R)/F_{ref}$) (Note 1)	01100 (60 μ s with 13 MHz f_{REF})
DCOCL3	DCOC control [16:13]	Tracking timing for DCOCL3 ($tT_H3 = (DCOCL3 \times 128 \times R)/F_{ref}$) (Note 1)	0110 (60 μ s with 13 MHz f_{REF})
FEENA_TIM	FEENA relative to initial track [20:17]	Front end enable timing ($tFEENA = (FEENA_TIM \times 128 \times R)/F_{ref}$) (Note 1)	0100 (40 μ s with 13 MHz f_{REF})
NU	Not used [21]	Not used	0
NU	Not used [22]	Not used	0
NU	Not used [23]	Not used	0

Note 1: See Figure 3 and Figure 4.

Table 18. R3 IP2 Calibration Register

Symbol	Function	State Description
ADDR	Address bits [5:0]. Must be set to 001101b (see Table 12)	
ADDR_SEL	Channel selection [6]	0 selects Q channel 1 selects I channel
RSVD	Reserved [7]	Must be set to 1 for correct operation
CORR_DATA	IP2 correction coefficient [15:8]	Coefficient for adjustment of receiver IP2: Bit [15] sets polarity: 0 = Positive 1 = Negative Bit [14:8]: 1111111 minimum correction • • • 0000000 maximum correction Bit [14] = MSB Bit [8] = LSB
NU	Not used [23:16]	Not used

Table 19. R4 PAC Timing Control Register

Symbol	Function	State Description	Default (Binary)
ADDR	Address bits [5:0]. Must be set to 011101b (see Table 12)		
RSVD	Reserved [11:6]	Reserved. Must be set to default value.	000010
PAC_TIME	PAC timing control [19:12]	Bit [19:12] sets timing for the PAC pedestal. When all bits = 0, no pedestal. Bit [12] = MSB = $1024/f_{\text{PFD}} = 78.7 \mu\text{s}$ for $f_{\text{PFD}} = 13 \text{ MHz}$ Bit [19] = LSB = $8/f_{\text{PFD}} = 0.615 \mu\text{s}$ for $f_{\text{PFD}} = 13 \text{ MHz}$	10011010 = 54.769 μs
RSVD	Reserved [23:20]	Reserved. Must be set to default value.	0100

Table 20. R6 VCXO Control Register

Symbol	Function Description	Internal Power-On Value (Binary)	Recommended Operational Value (Binary)
ADDR	Address bits [6:0]. Must be set to 0101101b (see Table 12)		
CAP_A	Bit [11:7] capacitor A array control. Binary weighted. Bit [11] = LSB = 1/8 pF Bit [7] = MSB = 2 pF Array composition = 2 pF, 1 pF, 0.5 pF, 0.25 pF, 0.125 pF	00001	Determined during a one-time factory calibration
CAP_B	Bit [15:12] capacitor B array control. Binary weighted. Bit [15] = LSB = 1/32 pF Bit [12] = MSB = 1/4 pF Array composition = 0.25 pF, 0.125 pF, 0.065 pF, 0.03125 pF	0000	
RSVD	Bit [23:16] reserved	00000000	00000000

Note: Programmed values in this register are not maintained with VDDBB (pin 43).

Table 21. R7 VCXO Control Register

Symbol	Function Description	Internal Power-On Value (Binary)	Recommended Operational Value (Binary)
ADDR	Address bits [6:0]. Must be set to 1101101b (see Table 12)		
I_VCXO	Bit [10:7] negative resistance current control. Binary weighted. Negative logic (on = low, off = high) Bit [10] = LSB = 8 μ A Bit [7] = MSB = 64 μ A Stepped values = 64 μ A, 32 μ A, 16 μ A, 8 μ A	0101	1001
RSVD	Bit [23:11] reserved. Must be set to default value.	000000000000	000000001110 (Must Use)

Note: Programmed values in this register are not maintained with VDDDB (pin 43).

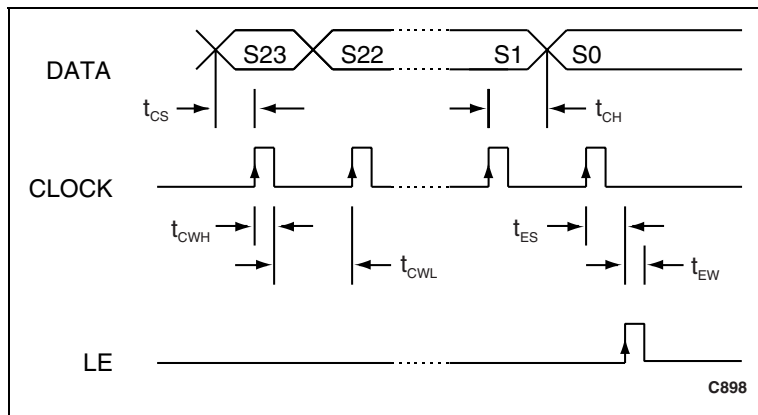

Figure 9. Serial Data Input Timing Diagram For Transceiver

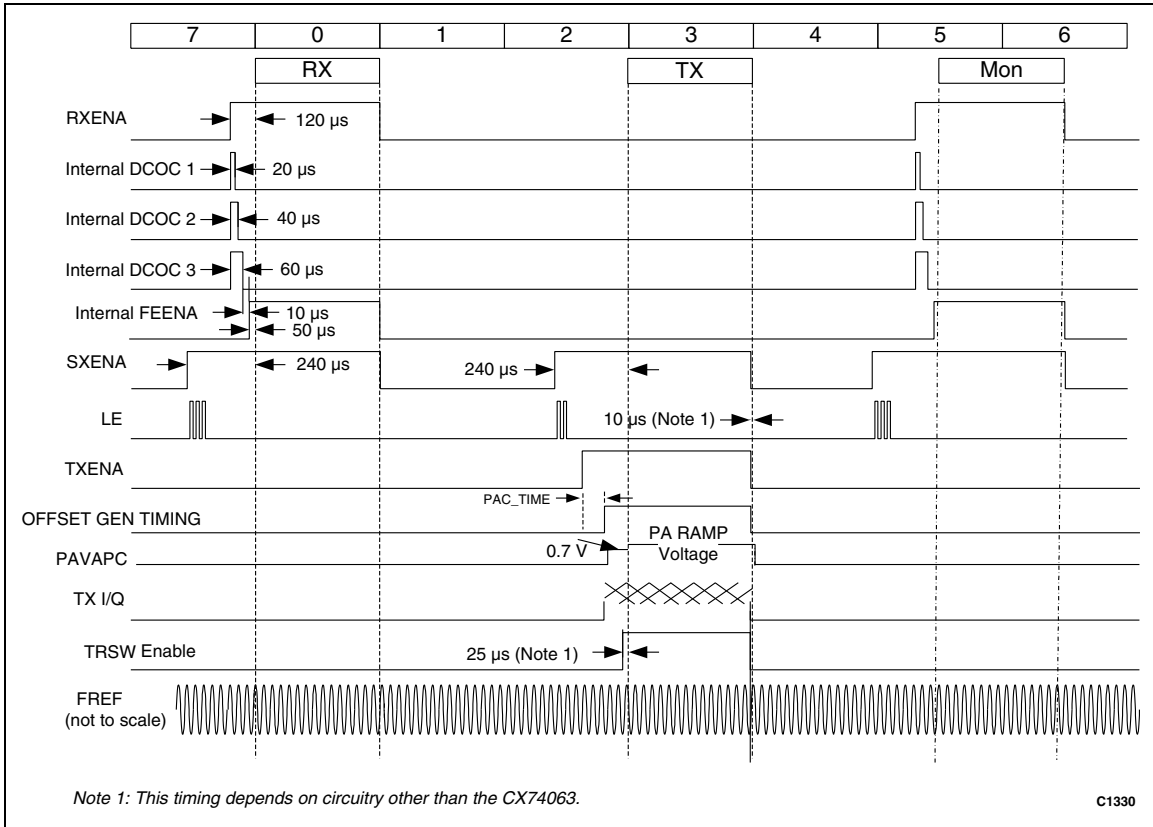

Figure 10. CX74063-26 Signal Timing Example (Normal Operation)

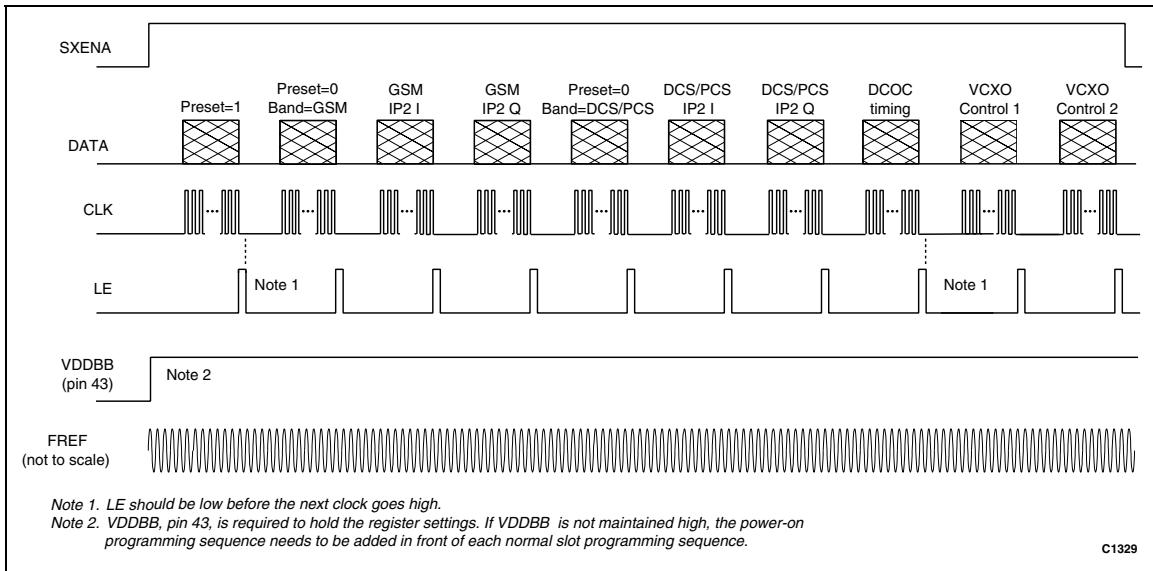

Figure 11. CX74063-26 Register Programming Sequence and Timing Example (Initialization After Power Up)

Receiver Data

Table 22. Recommended EGSM900/GSM850 AGC Data (1 of 2)
(AGC Setpoint = - 25.2 dBV = 55.0 mVrms)

Antenna Input (dBm)		External Front End Losses (dB)	LNA (dB)	Mixer (dB)	LPF (dB)	VGA1 (dB)	VGA1 Fine (dB)	Aux (dB)	VGA2 (dB)	Internal Inter-stage Losses (dB)	Total voltage Gain (dB)	I/Q Output (dBV)	
From	To											From	To
-110	-108	-4.0	15	40	10	18	4	0	18	-4.2	96.8	-26.2	-24.2
-108	-106	-4.0	15	40	10	18	2	0	18	-4.2	94.8	-26.2	-24.2
-106	-104	-4.0	15	40	10	18	0	0	18	-4.2	92.8	-26.2	-24.2
-104	-102	-4.0	15	40	10	12	4	0	18	-4.2	90.8	-26.2	-24.2
-102	-100	-4.0	15	40	10	12	2	0	18	-4.2	88.8	-26.2	-24.2
-100	-98	-4.0	15	40	10	12	0	0	18	-4.2	86.8	-26.2	-24.2
-98	-96	-4.0	15	40	10	6	4	0	18	-4.2	84.8	-26.2	-24.2
-96	-94	-4.0	15	40	10	6	2	0	18	-4.2	82.8	-26.2	-24.2
-94	-92	-4.0	15	40	10	6	0	0	18	-4.2	80.8	-26.2	-24.2
-92	-90	-4.0	15	40	10	0	4	0	18	-4.2	78.8	-26.2	-24.2
-90	-88	-4.0	15	40	10	0	2	0	18	-4.2	76.8	-26.2	-24.2
-88	-86	-4.0	15	40	10	0	0	0	18	-4.2	74.8	-26.2	-24.2
-86	-84	-4.0	15	40	-2	6	4	0	18	-4.2	72.8	-26.2	-24.2
-84	-82	-4.0	15	40	-2	6	2	0	18	-4.2	70.8	-26.2	-24.2
-82	-80	-4.0	15	40	-2	6	0	0	18	-4.2	68.8	-26.2	-24.2
-80	-78	-4.0	15	40	-2	0	4	0	18	-4.2	66.8	-26.2	-24.2
-78	-76	-4.0	15	40	-2	0	2	0	18	-4.2	64.8	-26.2	-24.2
-76	-74	-4.0	15	40	-2	0	0	0	18	-4.2	62.8	-26.2	-24.2
-74	-72	-4.0	15	22	10	0	4	0	18	-4.2	60.8	-26.2	-24.2
-72	-70	-4.0	15	22	10	0	2	0	18	-4.2	58.8	-26.2	-24.2
-70	-68	-4.0	15	22	10	0	0	0	18	-4.2	56.8	-26.2	-24.2
-68	-66	-4.0	15	22	-2	6	4	0	18	-4.2	54.8	-26.2	-24.2
-66	-64	-4.0	15	22	-2	6	2	0	18	-4.2	52.8	-26.2	-24.2
-64	-62	-4.0	15	22	-2	6	0	0	18	-4.2	50.8	-26.2	-24.2
-62	-60	-4.0	15	22	-2	0	4	0	18	-4.2	48.8	-26.2	-24.2
-60	-58	-4.0	15	22	-2	0	2	0	18	-4.2	46.8	-26.2	-24.2
-58	-56	-4.0	15	22	-2	0	0	0	18	-4.2	44.8	-26.2	-24.2
-56	-54	-4.0	-5	22	10	6	0	0	18	-4.2	42.8	-26.2	-24.2
-54	-52	-4.0	-5	22	10	0	4	0	18	-4.2	40.8	-26.2	-24.2

Table 22. Recommended EGSM900/GSM850 AGC Data (2 of 2)
(AGC Setpoint = - 25.2 dBV = 55.0 mVrms)

Antenna Input (dBm)		External Front End Losses (dB)	LNA (dB)	Mixer (dB)	LPF (dB)	VGA1 (dB)	VGA1 Fine (dB)	Aux (dB)	VGA2 (dB)	Internal Inter-stage Losses (dB)	Total voltage Gain (dB)	I/Q Output (dBV)	
From	To											From	To
-52	-50	-4.0	-5	22	10	0	2	0	18	-4.2	38.8	-26.2	-24.2
-50	-48	-4.0	-5	22	10	0	0	0	18	-4.2	36.8	-26.2	-24.2
-48	-46	-4.0	-5	22	-2	6	4	0	18	-4.2	34.8	-26.2	-24.2
-46	-44	-4.0	-5	22	-2	6	2	0	18	-4.2	32.8	-26.2	-24.2
-44	-42	-4.0	-5	22	-2	6	0	0	18	-4.2	30.8	-26.2	-24.2
-42	-40	-4.0	-5	22	-2	0	4	0	18	-4.2	28.8	-26.2	-24.2
-40	-38	-4.0	-5	22	-2	0	2	0	18	-4.2	26.8	-26.2	-24.2
-38	-36	-4.0	-5	22	-2	0	0	0	18	-4.2	24.8	-26.2	-24.2
-36	-34	-4.0	-5	22	-2	0	4	0	12	-4.2	22.8	-26.2	-24.2
-34	-32	-4.0	-5	22	-2	0	2	0	12	-4.2	20.8	-26.2	-24.2
-32	-30	-4.0	-5	22	-2	0	0	0	12	-4.2	18.8	-26.2	-24.2
-30	-28	-4.0	-5	22	-2	0	4	0	6	-4.2	16.8	-26.2	-24.2
-28	-26	-4.0	-5	22	-2	0	2	0	6	-4.2	14.8	-26.2	-24.2
-26	-24	-4.0	-5	22	-2	0	0	0	6	-4.2	12.8	-26.2	-24.2
-24	-22	-4.0	-5	22	-2	0	4	0	0	-4.2	10.8	-26.2	-24.2
-22	-20	-4.0	-5	22	-2	0	2	0	0	-4.2	8.8	-26.2	-24.2
-20	-18	-4.0	-5	22	-2	0	0	0	0	-4.2	6.8	-26.2	-24.2
-18	-16	-4.0	-5	22	-2	0	0	0	0	-4.2	6.8	-24.2	-22.2
-16	-14	-4.0	-5	22	-2	0	0	0	0	-4.2	6.8	-22.2	-20.2

Table 23. Recommended DCS1800 AGC Data (1 of 2)
(AGC Setpoint = - 24.2 dBV = 61.7 mVrms)

Antenna Input (dBm)		External Front End Losses (dB)	LNA (dB)	Mixer (dB)	LPF (dB)	VGA1 (dB)	VGA1 Fine (dB)	Aux (dB)	VGA2 (dB)	Internal Inter-stage Losses (dB)	Total voltage Gain (dB)	I/Q Output (dBV)	
From	To											From	To
-110	-108	-4.2	15	40	10	24	0	0	18	-5.0	97.8	-25.2	-23.2
-108	-106	-4.2	15	40	10	18	4	0	18	-5.0	95.8	-25.2	-23.2
-106	-104	-4.2	15	40	10	18	2	0	18	-5.0	93.8	-25.2	-23.2
-104	-102	-4.2	15	40	10	18	0	0	18	-5.0	91.8	-25.2	-23.2
-102	-100	-4.2	15	40	10	12	4	0	18	-5.0	89.8	-25.2	-23.2
-100	-98	-4.2	15	40	10	12	2	0	18	-5.0	87.8	-25.2	-23.2
-98	-96	-4.2	15	40	10	12	0	0	18	-5.0	85.8	-25.2	-23.2
-96	-94	-4.2	15	40	10	6	4	0	18	-5.0	83.8	-25.2	-23.2
-94	-92	-4.2	15	40	10	6	2	0	18	-5.0	81.8	-25.2	-23.2
-92	-90	-4.2	15	40	10	6	0	0	18	-5.0	79.8	-25.2	-23.2
-90	-88	-4.2	15	40	10	0	4	0	18	-5.0	77.8	-25.2	-23.2
-88	-86	-4.2	15	40	10	0	2	0	18	-5.0	75.8	-25.2	-23.2
-86	-84	-4.2	15	40	10	0	0	0	18	-5.0	73.8	-25.2	-23.2
-84	-82	-4.2	15	40	-2	6	4	0	18	-5.0	71.8	-25.2	-23.2
-82	-80	-4.2	15	40	-2	6	2	0	18	-5.0	69.8	-25.2	-23.2
-80	-78	-4.2	15	40	-2	6	0	0	18	-5.0	67.8	-25.2	-23.2
-78	-76	-4.2	15	40	-2	0	4	0	18	-5.0	65.8	-25.2	-23.2
-76	-74	-4.2	15	40	-2	0	2	0	18	-5.0	63.8	-25.2	-23.2
-74	-72	-4.2	15	40	-2	0	0	0	18	-5.0	61.8	-25.2	-23.2
-72	-70	-4.2	15	22	10	0	4	0	18	-5.0	59.8	-25.2	-23.2
-70	-68	-4.2	15	22	10	0	2	0	18	-5.0	57.8	-25.2	-23.2
-68	-66	-4.2	15	22	10	0	0	0	18	-5.0	55.8	-25.2	-23.2
-66	-64	-4.2	15	22	10	6	4	0	18	-5.0	53.8	-25.2	-23.2
-64	-62	-4.2	15	22	-2	6	2	0	18	-5.0	51.8	-25.2	-23.2
-62	-60	-4.2	15	22	-2	6	0	0	18	-5.0	49.8	-25.2	-23.2
-60	-58	-4.2	15	22	-2	0	4	0	18	-5.0	47.8	-25.2	-23.2
-58	-56	-4.2	15	22	-2	0	2	0	18	-5.0	45.8	-25.2	-23.2
-56	-54	-4.2	15	22	-2	0	0	0	18	-5.0	43.8	-25.2	-23.2
-54	-52	-4.2	-7	22	10	6	2	0	18	-5.0	41.8	-25.2	-23.2
-52	-50	-4.2	-7	22	10	6	0	0	18	-5.0	39.8	-25.2	-23.2

Table 23. Recommended DCS1800 AGC Data (2 of 2)
(AGC Setpoint = - 24.2 dBV = 61.7 mVrms)

Antenna Input (dBm)		External Front End Losses (dB)	LNA (dB)	Mixer (dB)	LPF (dB)	VGA1 (dB)	VGA1 Fine (dB)	Aux (dB)	VGA2 (dB)	Internal Inter-stage Losses (dB)	Total voltage Gain (dB)	I/Q Output (dBV)	
From	To											From	To
-50	-48	-4.2	-7	22	10	0	4	0	18	-5.0	37.8	-25.2	-23.2
-48	-46	-4.2	-7	22	10	0	2	0	18	-5.0	35.8	-25.2	-23.2
-46	-44	-4.2	-7	22	10	0	0	0	18	-5.0	33.8	-25.2	-23.2
-44	-42	-4.2	-7	22	-2	6	4	0	18	-5.0	31.8	-25.2	-23.2
-42	-40	-4.2	-7	22	-2	6	2	0	18	-5.0	29.8	-25.2	-23.2
-40	-38	-4.2	-7	22	-2	6	0	0	18	-5.0	27.8	-25.2	-23.2
-38	-36	-4.2	-7	22	-2	0	4	0	18	-5.0	25.8	-25.2	-23.2
-36	-34	-4.2	-7	22	-2	0	2	0	18	-5.0	23.8	-25.2	-23.2
-34	-32	-4.2	-7	22	-2	0	0	0	18	-5.0	21.8	-25.2	-23.2
-32	-30	-4.2	-7	22	-2	0	4	0	12	-5.0	19.8	-25.2	-23.2
-30	-28	-4.2	-7	22	-2	0	2	0	12	-5.0	17.8	-25.2	-23.2
-28	-26	-4.2	-7	22	-2	0	0	0	12	-5.0	15.8	-25.2	-23.2
-26	-24	-4.2	-7	22	-2	0	4	0	6	-5.0	13.8	-25.2	-23.2
-24	-22	-4.2	-7	22	-2	0	2	0	6	-5.0	11.8	-25.2	-23.2
-22	-20	-4.2	-7	22	-2	0	0	0	6	-5.0	9.8	-25.2	-23.2
-20	-18	-4.2	-7	22	-2	0	4	0	0	-5.0	7.8	-25.2	-23.2
-18	-16	-4.2	-7	22	-2	0	2	0	0	-5.0	5.8	-25.2	-23.2
-16	-14	-4.2	-7	22	-2	0	0	0	0	-5.0	5.8	-23.2	-21.2

Table 24. Recommended PCS1900 AGC Data (1 of 2)
(AGC Setpoint = - 25.4 dBV = 53.7 mVrms)

Antenna Input (dBm)		External Front End Losses (dB)	LNA (dB)	Mixer (dB)	LPF (dB)	VGA1 (dB)	VGA1 Fine (dB)	Aux (dB)	VGA2 (dB)	Internal Inter-stage Losses (dB)	Total voltage Gain (dB)	I/Q Output (dBV)	
From	To											From	To
-110	-108	-4.2	15	40	10	24	0	0	18	-6.2	96.6	-26.4	-24.4
-108	-106	-4.2	15	40	10	18	4	0	18	-6.2	94.6	-26.4	-24.4
-106	-104	-4.2	15	40	10	18	2	0	18	-6.2	92.6	-26.4	-24.4
-104	-102	-4.2	15	40	10	18	0	0	18	-6.2	90.6	-26.4	-24.4
-102	-100	-4.2	15	40	10	12	4	0	18	-6.2	88.6	-26.4	-24.4
-100	-98	-4.2	15	40	10	12	2	0	18	-6.2	86.6	-26.4	-24.4
-98	-96	-4.2	15	40	10	12	0	0	18	-6.2	84.6	-26.4	-24.4
-96	-94	-4.2	15	40	10	6	4	0	18	-6.2	82.6	-26.4	-24.4
-94	-92	-4.2	15	40	10	6	2	0	18	-6.2	80.6	-26.4	-24.4
-92	-90	-4.2	15	40	10	6	0	0	18	-6.2	78.6	-26.4	-24.4
-90	-88	-4.2	15	40	10	0	4	0	18	-6.2	76.6	-26.4	-24.4
-88	-86	-4.2	15	40	10	0	2	0	18	-6.2	74.6	-26.4	-24.4
-86	-84	-4.2	15	40	10	0	0	0	18	-6.2	72.6	-26.4	-24.4
-84	-82	-4.2	15	40	-2	6	4	0	18	-6.2	70.6	-26.4	-24.4
-82	-80	-4.2	15	40	-2	6	2	0	18	-6.2	68.6	-26.4	-24.4
-80	-78	-4.2	15	40	-2	6	0	0	18	-6.2	66.6	-26.4	-24.4
-78	-76	-4.2	15	40	-2	0	4	0	18	-6.2	64.6	-26.4	-24.4
-76	-74	-4.2	15	40	-2	0	2	0	18	-6.2	62.6	-26.4	-24.4
-74	-72	-4.2	15	40	-2	0	0	0	18	-6.2	60.6	-26.4	-24.4
-72	-70	-4.2	15	22	10	0	4	0	18	-6.2	58.6	-26.4	-24.4
-70	-68	-4.2	15	22	10	0	2	0	18	-6.2	56.6	-26.4	-24.4
-68	-66	-4.2	15	22	10	0	0	0	18	-6.2	54.6	-26.4	-24.4
-66	-64	-4.2	15	22	-2	6	4	0	18	-6.2	52.6	-26.4	-24.4
-64	-62	-4.2	15	22	-2	6	2	0	18	-6.2	50.6	-26.4	-24.4
-62	-60	-4.2	15	22	-2	6	0	0	18	-6.2	48.6	-26.4	-24.4
-60	-58	-4.2	15	22	-2	0	4	0	18	-6.2	46.6	-26.4	-24.4
-58	-56	-4.2	15	22	-2	0	2	0	18	-6.2	44.6	-26.4	-24.4
-56	-54	-4.2	15	22	-2	0	0	0	18	-6.2	42.6	-26.4	-24.4
-54	-52	-4.2	-5	22	10	6	0	0	18	-6.2	40.6	-26.4	-24.4
-52	-50	-4.2	-5	22	10	0	4	0	18	-6.2	38.6	-26.4	-24.4

Table 24. Recommended PCS1900 AGC Data (2 of 2)
(AGC Setpoint = - 25.4 dBV = 53.7 mVrms)

Antenna Input (dBm)		External Front End Losses (dB)	LNA (dB)	Mixer (dB)	LPF (dB)	VGA1 (dB)	VGA1 Fine (dB)	Aux (dB)	VGA2 (dB)	Internal Inter-stage Losses (dB)	Total voltage Gain (dB)	I/Q Output (dBV)	
From	To											From	To
-50	-48	-4.2	-5	22	10	0	2	0	18	-6.2	36.6	-26.4	-24.4
-48	-46	-4.2	-5	22	10	0	0	0	18	-6.2	34.6	-26.4	-24.4
-46	-44	-4.2	-5	22	-2	6	4	0	18	-6.2	32.6	-26.4	-24.4
-44	-42	-4.2	-5	22	-2	6	2	0	18	-6.2	30.6	-26.4	-24.4
-42	-40	-4.2	-5	22	-2	6	0	0	18	-6.2	28.6	-26.4	-24.4
-40	-38	-4.2	-5	22	-2	0	4	0	18	-6.2	26.6	-26.4	-24.4
-38	-36	-4.2	-5	22	-2	0	2	0	18	-6.2	24.6	-26.4	-24.4
-36	-34	-4.2	-5	22	-2	0	0	0	18	-6.2	22.6	-26.4	-24.4
-34	-32	-4.2	-5	22	-2	0	4	0	12	-6.2	20.6	-26.4	-24.4
-32	-30	-4.2	-5	22	-2	0	2	0	12	-6.2	18.6	-26.4	-24.4
-30	-28	-4.2	-5	22	-2	0	0	0	12	-6.2	16.6	-26.4	-24.4
-28	-26	-4.2	-5	22	-2	0	4	0	6	-6.2	14.6	-26.4	-24.4
-26	-24	-4.2	-5	22	-2	0	2	0	6	-6.2	12.6	-26.4	-24.4
-24	-22	-4.2	-5	22	-2	0	0	0	6	-6.2	10.6	-26.4	-24.4
-22	-20	-4.2	-5	22	-2	0	4	0	0	-6.2	8.6	-26.4	-24.4
-20	-18	-4.2	-5	22	-2	0	2	0	0	-6.2	6.6	-26.4	-24.4
-18	-16	-4.2	-5	22	-2	0	0	0	0	-6.2	4.6	-26.4	-24.4
-16	-14	-4.2	-5	22	-2	0	0	0	0	-6.2	4.6	-24.4	-22.4

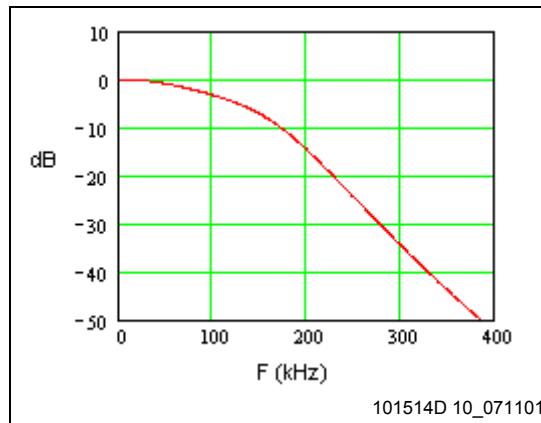

Figure 12. Typical Baseband Frequency Response

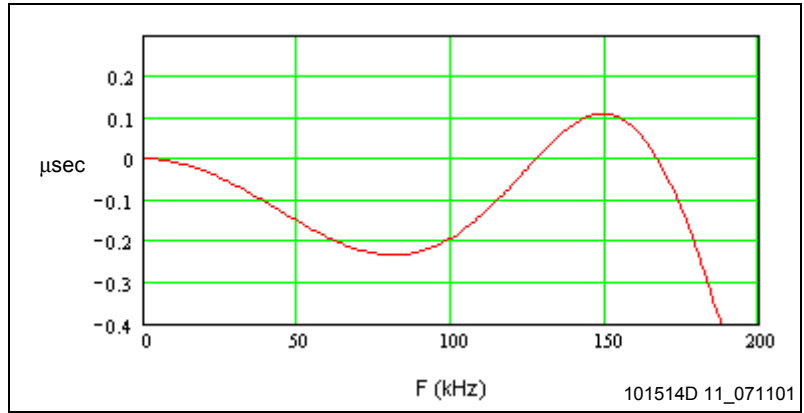

Figure 13. Typical Differential Delay Response

Table 25. EGSM900/GSM850 LNA S11 (Normalized to 50 Ω)

Frequency (MHz)	S11
869.0	0.386 – 0.632j
878.1	0.438 – 0.630j
887.2	0.454 – 0.629j
896.3	0.420 – 0.639j
905.4	0.403 – 0.642j
914.5	0.398 – 0.646j
923.6	0.371 – 0.653j
932.7	0.376 – 0.653j
941.8	0.379 – 0.657j
950.9	0.343 – 0.664j
960.0	0.350 – 0.664j

Table 26. DCS1800 LNA S11 (Normalized to 50 Ω)

Frequency (MHz)	S11
1805.0	0.0205 – 0.649j
1812.5	0.205 – 0.689j
1820.0	0.275 – 0.704j
1827.5	0.299 – 0.710j
1835.0	0.319 – 0.713j
1842.5	0.326 – 0.718j
1850.0	0.316 – 0.722j
1857.5	0.306 – 0.722j
1865.0	0.307 – 0.722j
1872.5	0.300 – 0.724j
1880.0	0.287 – 0.724j

Table 27. PCS1900 LNA S11 (Normalized to 50 Ω)

Frequency (MHz)	S11
1930	0.237 – 0.583j
1936	0.362 – 0.595j
1942	0.432 – 0.591j
1948	0.472 – 0.589j
1954	0.489 – 0.591j
1960	0.488 – 0.597j
1966	0.483 – 0.600j
1972	0.485 – 0.600j
1978	0.484 – 0.600j
1984	0.475 – 0.603j
1990	0.465 – 0.605j

Table 28. Typical EGSM and GSM850 Band Noise Figure vs. Gain Data

Gain	NF	Gain	NF	Gain	NF	Gain	NF	Gain	NF	Gain	NF
100.8	3.17	84.8	3.38	68.8	7.60	52.8	22.50	36.8	39.71	20.8	43.56
98.8	3.17	82.8	3.48	66.8	8.39	50.8	23.76	34.8	41.11	18.8	45.01
96.8	3.17	80.8	3.59	64.8	11.80	48.8	24.92	32.8	42.46	16.8	46.39
94.8	3.18	78.8	3.73	62.8	12.77	46.8	30.21	30.8	43.73	14.8	45.89
92.8	3.20	76.8	4.90	60.8	13.71	44.8	31.29	28.8	44.89	12.8	47.58
90.8	3.22	74.8	5.44	58.8	18.43	42.8	32.37	26.8	42.70	10.8	49.25
88.8	3.26	72.8	6.08	56.8	19.79	40.8	33.39	24.8	44.02		
86.8	3.31	70.8	6.82	54.8	21.16	38.8	38.32	22.8	45.24		

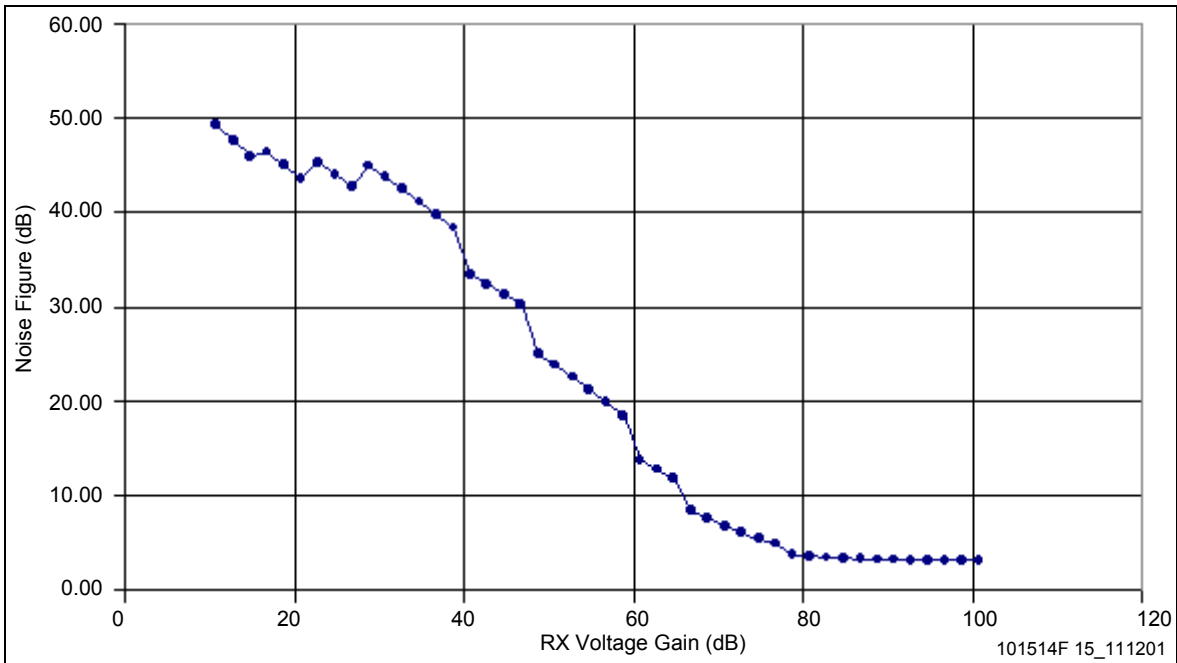

Figure 14. Typical EGSM and GSM850 Band Noise Figure vs. Voltage Gain Curve (CX74063-26 Only, No Front End Loss)

Table 29. Typical EGSM and GSM850 Band Dynamic Range Data (Includes 4.0 dB Front End Loss)

Input	Noise Floor	P1dB	Gain	Input	Noise Floor	P1dB	Gain	Input	Noise Floor	P1dB	Gain
-109.0	-113.0	-78.6	97.8	-77.0	-108.2	-52.4	65.8	-45.0	-78.6	-21.2	33.8
-107.0	-113.0	-76.6	95.8	-75.0	-107.1	-52.0	63.8	-43.0	-74.5	-18.1	31.8
-105.0	-113.0	-74.6	93.8	-73.0	-106.0	-51.8	61.8	-41.0	-72.9	-17.7	29.8
-103.0	-113.0	-72.6	91.8	-71.0	-102.9	-43.4	59.8	-39.0	-71.4	-17.4	27.8
-101.0	-113.0	-70.6	89.8	-69.0	-101.6	-42.5	57.8	-37.0	-69.8	-17.2	25.8
-99.0	-113.0	-68.7	87.8	-67.0	-100.4	-41.9	55.8	-35.0	-68.3	-17.0	23.8
-97.0	-112.9	-66.9	85.8	-65.0	-96.4	-36.9	53.8	-33.0	-66.9	-17.0	21.8
-95.0	-112.9	-65.2	83.8	-63.0	-94.9	-35.9	51.8	-31.0	-66.9	-16.9	19.8
-93.0	-112.8	-63.7	81.8	-61.0	-93.4	-35.2	49.8	-29.0	-65.2	-16.9	17.8
-91.0	-112.7	-62.4	79.8	-59.0	-91.8	-34.6	47.8	-27.0	-63.4	-16.9	15.8
-89.0	-112.5	-61.4	77.8	-57.0	-90.3	-34.3	45.8	-25.0	-62.3	-16.8	13.8
-87.0	-112.3	-60.5	75.8	-55.0	-88.9	-34.0	43.8	-23.0	-60.3	-16.8	11.8
-85.0	-112.1	-59.9	73.8	-53.0	-83.8	-24.3	41.8	-21.0	-58.4	-16.8	9.8
-83.0	-110.8	-54.8	71.8	-51.0	-82.6	-23.2	39.8	-19.0	-56.7	-16.8	7.8
-81.0	-110.0	-53.8	69.8	-49.0	-81.3	-22.3	37.8	-17.0	-54.7	-16.8	5.8
-79.0	-109.2	-53.0	67.8	-47.0	-79.9	-21.7	35.8	-15.0	-52.7	-16.8	3.8

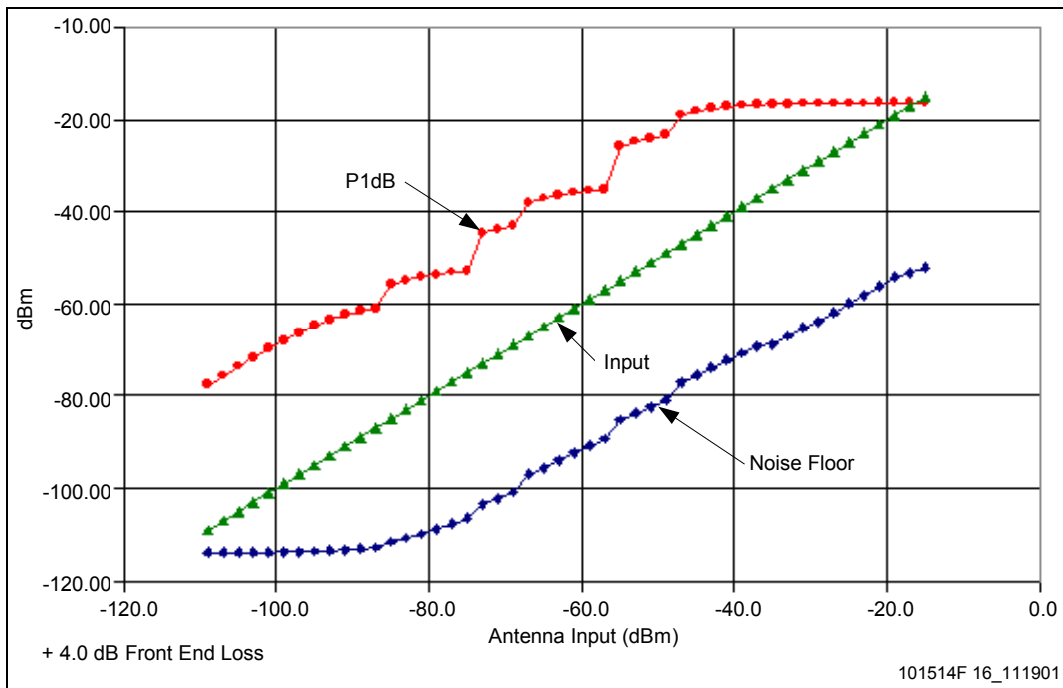

Figure 15. Typical EGSM and GSM850 Band Dynamic Range vs. Antenna Input Curve

Table 30. Typical DCS1800 Band Noise Figure vs. Gain Data

Gain	NF	Gain	NF	Gain	NF	Gain	NF	Gain	NF	Gain	NF
100	3.7	84	3.9	68	8.3	52	23.3	36	41.1	20	48.0
98	3.7	82	4.0	66	9.1	50	24.6	34	42.5	18	46.4
96	3.7	80	4.1	64	12.6	48	25.7	32	43.9	16	47.8
94	3.7	78	4.3	62	13.6	46	32.0	30	45.3	14	49.2
92	3.7	76	5.5	60	14.5	44	33.0	28	46.5	12	48.7
90	3.7	74	6.1	58	19.2	42	34.1	26	47.7	10	50.4
88	3.8	72	6.7	56	20.6	40	35.2	24	45.5		
86	3.8	70	7.5	54	22.0	38	36.2	22	46.8		

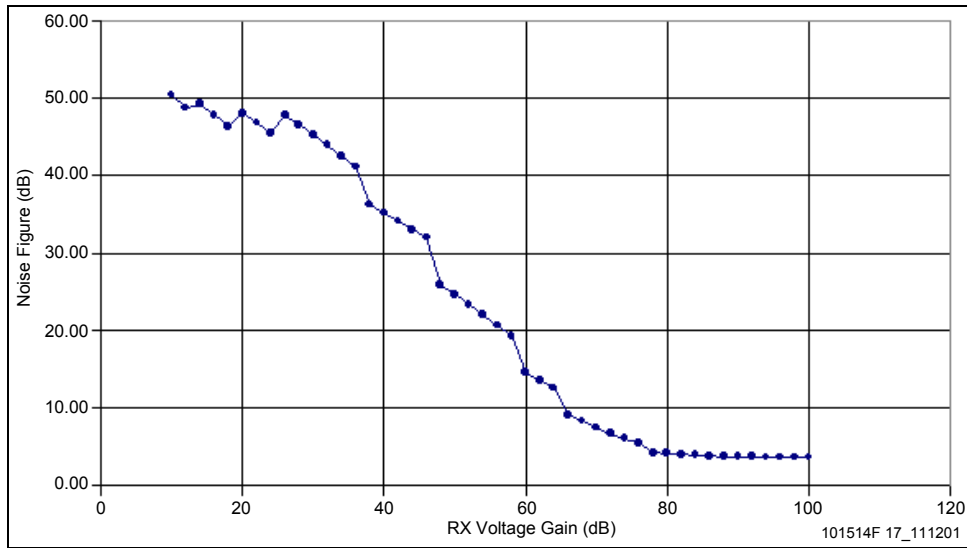

Figure 16. Typical DCS1800 Band Noise Figure vs. Voltage Gain Curve (CX74063-26 Only; No Front End Loss)

Table 31. Typical DCS1800 Band Dynamic Range Data (Includes 4.2 dB Front End Loss)

Input	Noise Floor	P1dB	Gain	Input	Noise Floor	P1dB	Gain	Input	Noise Floor	P1dB	Gain
-109.0	-113.0	-78.6	97.8	-77.0	-108.2	-52.4	65.8	-45.0	-78.6	-21.2	33.8
-107.0	-113.0	-76.6	95.8	-75.0	-107.1	-52.0	63.8	-43.0	-74.5	-18.1	31.8
-105.0	-113.0	-74.6	93.8	-73.0	-106.0	-51.8	61.8	-41.0	-72.9	-17.7	29.8
-103.0	-113.0	-72.6	91.8	-71.0	-102.9	-43.4	59.8	-39.0	-71.4	-17.4	27.8
-101.0	-113.0	-70.6	89.8	-69.0	-101.6	-42.5	57.8	-37.0	-69.8	-17.2	25.8
-99.0	-113.0	-68.7	87.8	-67.0	-100.4	-41.9	55.8	-35.0	-68.3	-17.0	23.8
-97.0	-112.9	-66.9	85.8	-65.0	-96.4	-36.9	53.8	-33.0	-66.9	-17.0	21.8
-95.0	-112.9	-65.2	83.8	-63.0	-94.9	-35.9	51.8	-31.0	-66.9	-16.9	19.8
-93.0	-112.8	-63.7	81.8	-61.0	-93.4	-35.2	49.8	-29.0	-65.2	-16.9	17.8
-91.0	-112.7	-62.4	79.8	-59.0	-91.8	-34.6	47.8	-27.0	-63.4	-16.9	15.8
-89.0	-112.5	-61.4	77.8	-57.0	-90.3	-34.3	45.8	-25.0	-62.3	-16.8	13.8
-87.0	-112.3	-60.5	75.8	-55.0	-88.9	-34.0	43.8	-23.0	-60.3	-16.8	11.8
-85.0	-112.1	-59.9	73.8	-53.0	-83.8	-24.3	41.8	-21.0	-58.4	-16.8	9.8
-83.0	-110.8	-54.8	71.8	-51.0	-82.6	-23.2	39.8	-19.0	-56.7	-16.8	7.8
-81.0	-110.0	-53.8	69.8	-49.0	-81.3	-22.3	37.8	-17.0	-54.7	-16.8	5.8
-79.0	-109.2	-53.0	67.8	-47.0	-79.9	-21.7	35.8	-15.0	-52.7	-16.8	3.8

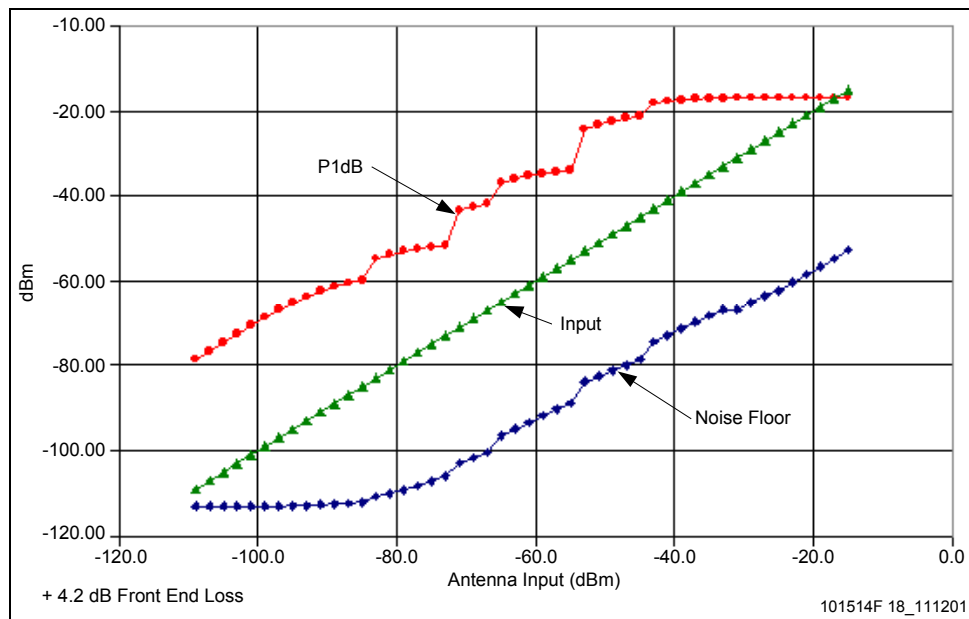

Figure 17. Typical DCS1800 Band Dynamic Range vs. Antenna Input Curve

Table 32. Typical PCS1900 Band Noise Figure vs. Gain Data

Gain	NF	Gain	NF	Gain	NF	Gain	NF	Gain	NF	Gain	NF
98.8	4.2	82.8	4.5	66.8	9.3	50.8	24.5	34.8	42.3	18.8	49.2
96.8	4.2	80.8	4.6	64.8	10.1	48.8	25.8	32.8	43.7	16.8	47.6
94.8	4.2	78.8	4.7	62.8	13.7	46.8	26.9	30.8	45.1	14.8	49.0
92.8	4.2	76.8	4.9	60.8	14.7	44.8	33.2	28.8	46.5	12.8	50.4
90.8	4.2	74.8	6.3	58.8	15.6	42.8	34.2	26.8	47.7	10.8	49.9
88.8	4.3	72.8	6.9	56.8	20.4	40.8	35.3	24.8	48.9	8.8	51.6
86.8	4.3	70.8	7.6	54.8	21.8	38.8	36.4	22.8	46.7	6.8	53.3
84.8	4.4	68.8	8.4	52.8	23.1	36.8	37.4	20.8	48.0		

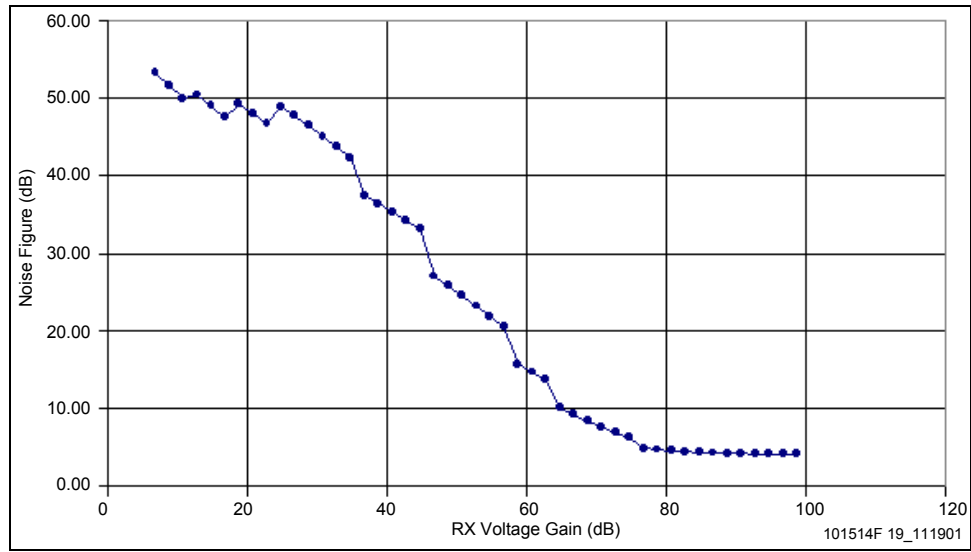

Figure 18. Typical PCS1900 Band Noise Figure vs. Voltage Gain Curve (CX74063-26 Only; No Front End Loss)

Table 33. Typical PCS1900 Band Dynamic Range Data (Includes 4.2 dB Front End Loss)

Input	Noise Floor	P1dB	Gain	Input	Noise Floor	P1dB	Gain	Input	Noise Floor	P1dB	Gain
-109.0	-112.5	-77.4	96.6	-77.0	-107.4	-51.2	64.6	-45.0	-77.7	-20.3	32.6
-107.0	-112.5	-75.4	94.6	-75.0	-106.3	-50.8	62.6	-43.0	-73.5	-17.6	30.6
-105.0	-112.5	-73.4	92.6	-73.0	-105.2	-50.6	60.6	-41.0	-72.0	-17.2	28.6
-103.0	-112.5	-71.4	90.6	-71.0	-102.0	-42.2	58.6	-39.0	-70.4	-17.0	26.6
-101.0	-112.5	-69.4	88.6	-69.0	-100.7	-41.3	56.6	-37.0	-68.9	-16.8	24.6
-99.0	-112.5	-67.5	86.6	-67.0	-99.5	-40.7	54.6	-35.0	-67.4	-16.7	22.6
-97.0	-112.4	-65.7	84.6	-65.0	-95.4	-35.7	52.6	-33.0	-66.0	-16.6	20.6
-95.0	-112.4	-64.0	82.6	-63.0	-93.9	-34.7	50.6	-31.0	-66.3	-16.6	18.6
-93.0	-112.3	-62.5	80.6	-61.0	-92.4	-34.0	48.6	-29.0	-64.6	-16.5	16.6
-91.0	-112.1	-61.2	78.6	-59.0	-90.9	-33.4	46.6	-27.0	-62.9	-16.5	14.6
-89.0	-112.0	-60.2	76.6	-57.0	-89.4	-33.1	44.6	-25.0	-61.8	-16.5	12.6
-87.0	-111.8	-59.3	74.6	-55.0	-88.0	-32.8	42.6	-23.0	-59.9	-16.5	10.6
-85.0	-111.5	-58.7	72.6	-53.0	-82.8	-23.3	40.6	-21.0	-58.0	-16.5	8.6
-83.0	-110.0	-53.6	70.6	-51.0	-81.6	-22.2	38.6	-19.0	-56.3	-16.5	6.6
-81.0	-109.3	-52.6	68.6	-49.0	-80.3	-21.4	36.6	-17.0	-54.3	-16.5	4.6
-79.0	-108.4	-51.8	66.6	-47.0	-79.0	-20.8	34.6	-15.0	-52.4	-16.5	2.6

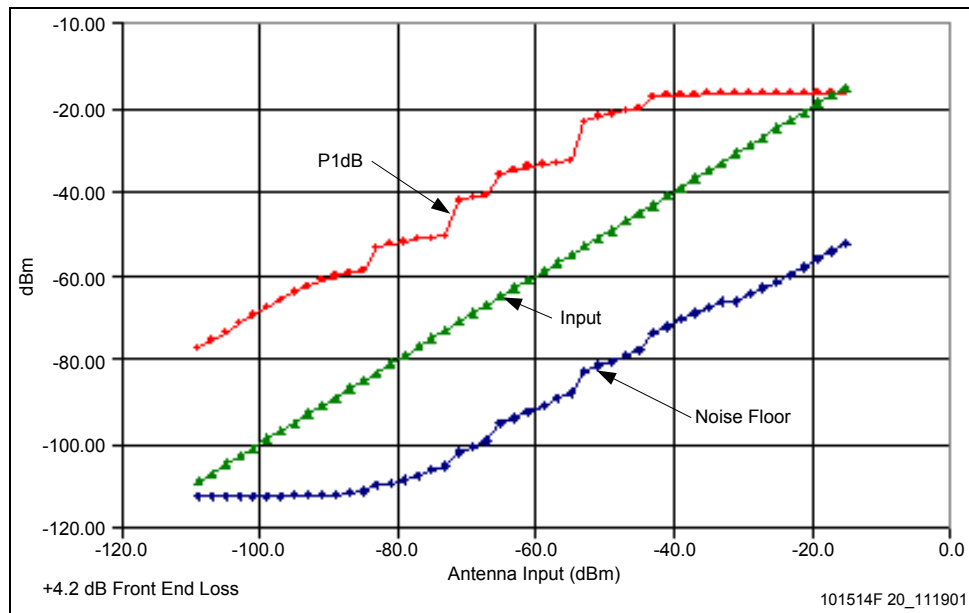

Figure 19. Typical PCS1900 Band Dynamic Range vs. Antenna Input Curve

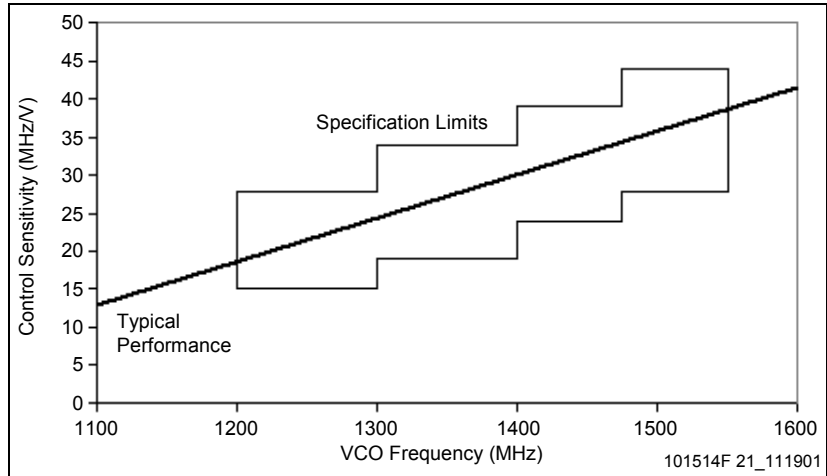

Figure 20. Typical Control Sensitivity, UHF VCO

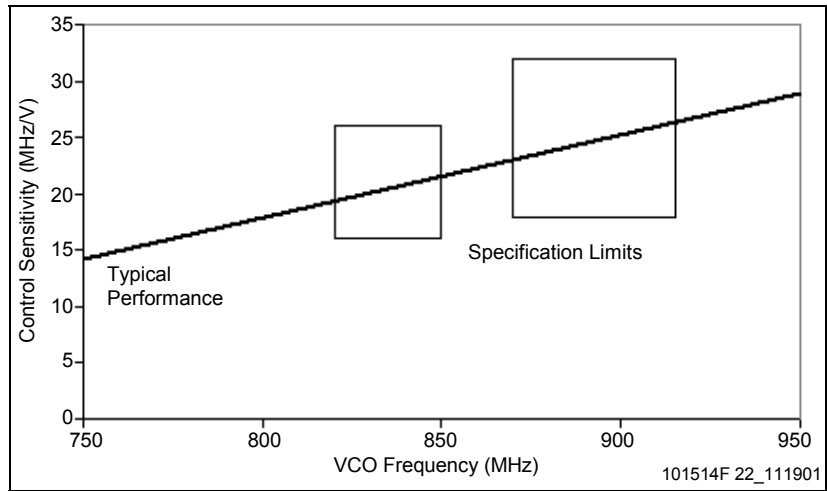

Figure 21. Typical Control Sensitivity, Low Band TX VCO

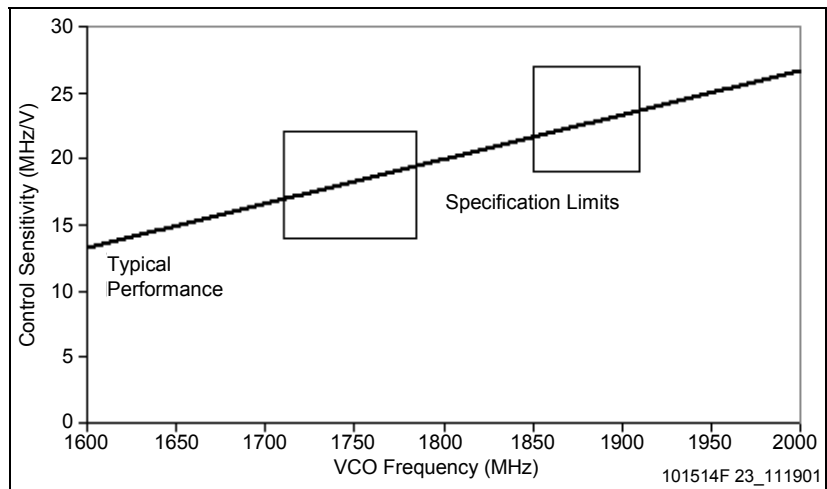

Figure 22. Typical Control Sensitivity, High Band TX VCO

Transmitter Data

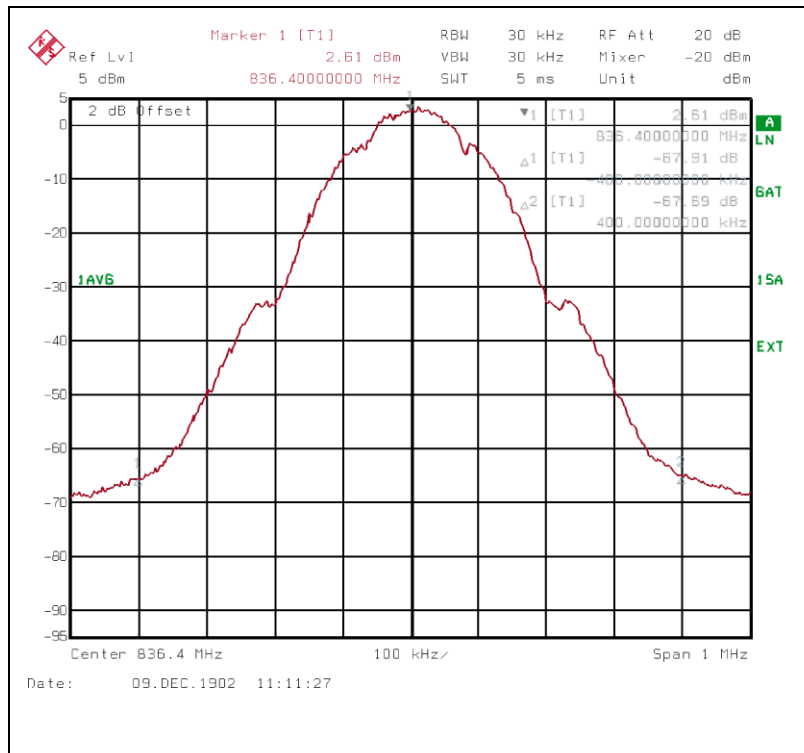

Figure 23. Typical GSM850 Band Output Spectrum

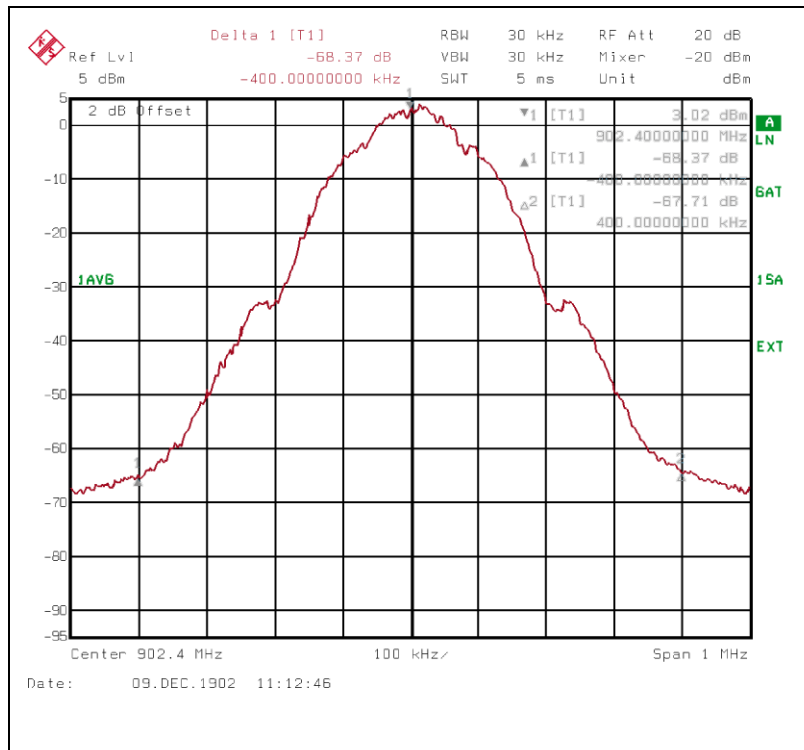

Figure 24. Typical EGSM Band Output Spectrum

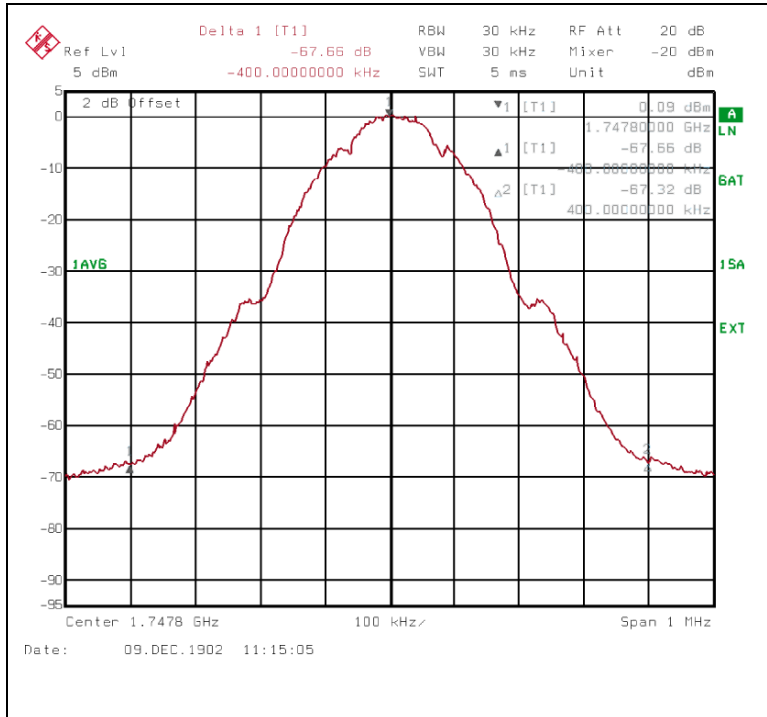

Figure 25. Typical DCS Band Output Spectrum

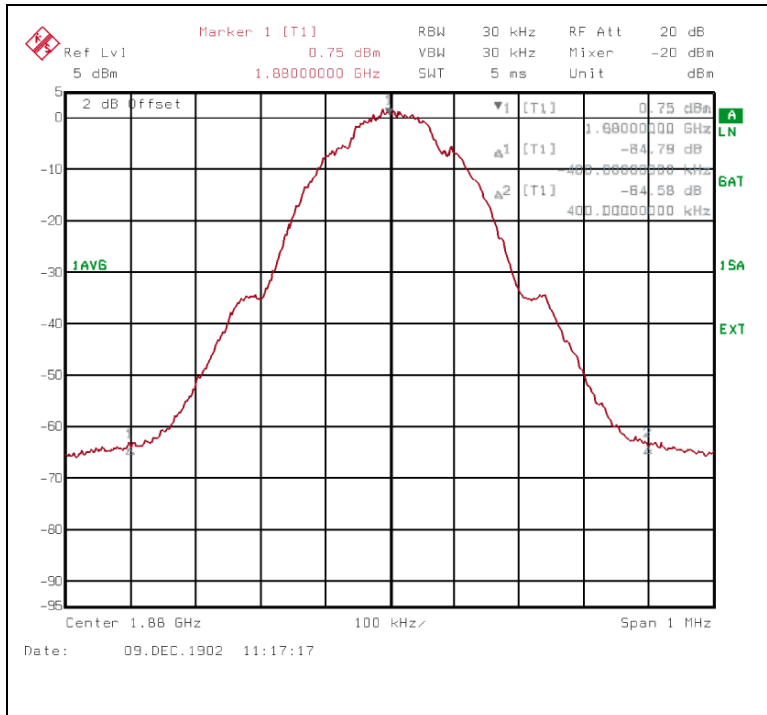

Figure 26. Typical PCS Band Output Spectrum

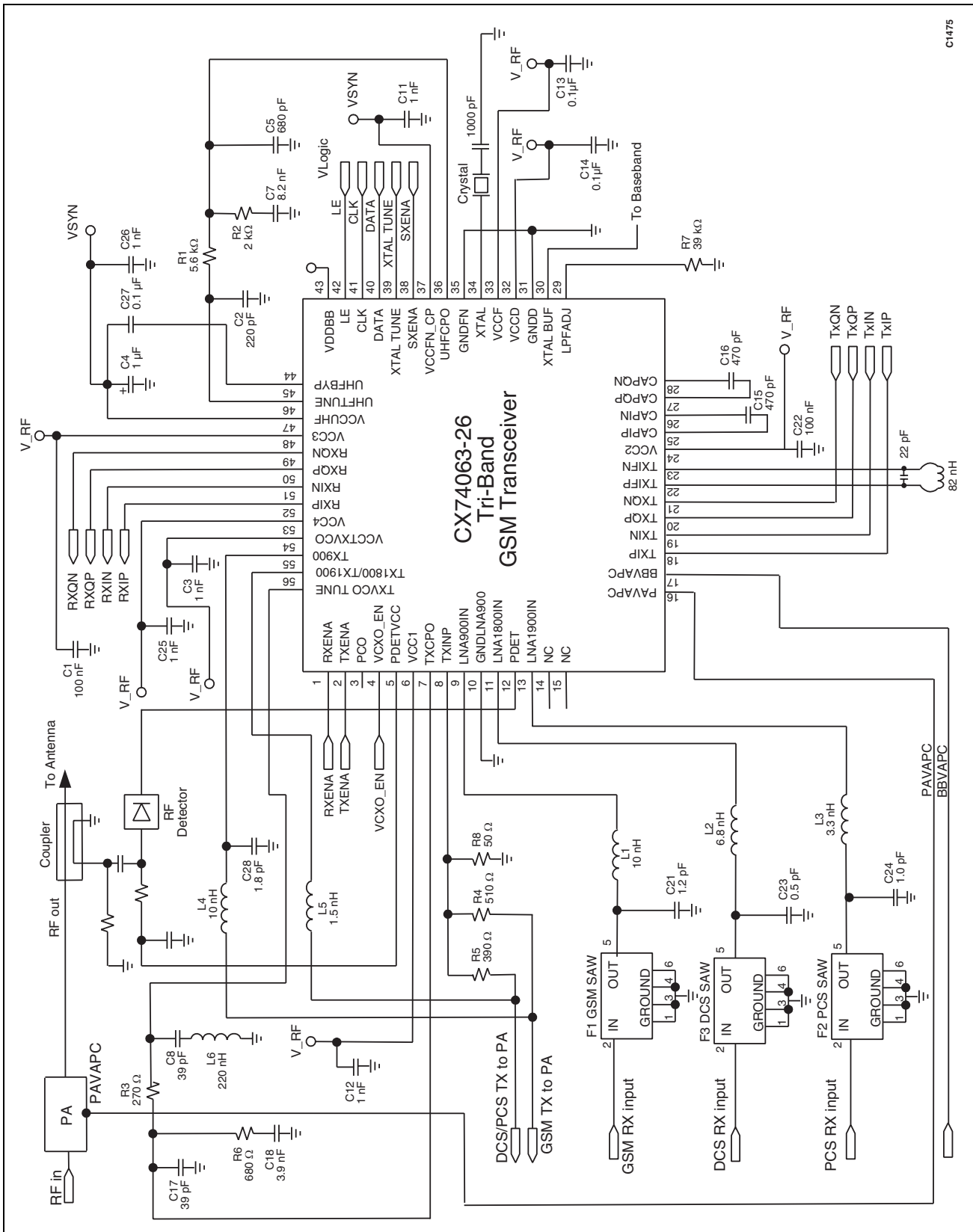

Figure 27. Typical CX74063-26 Application Circuit

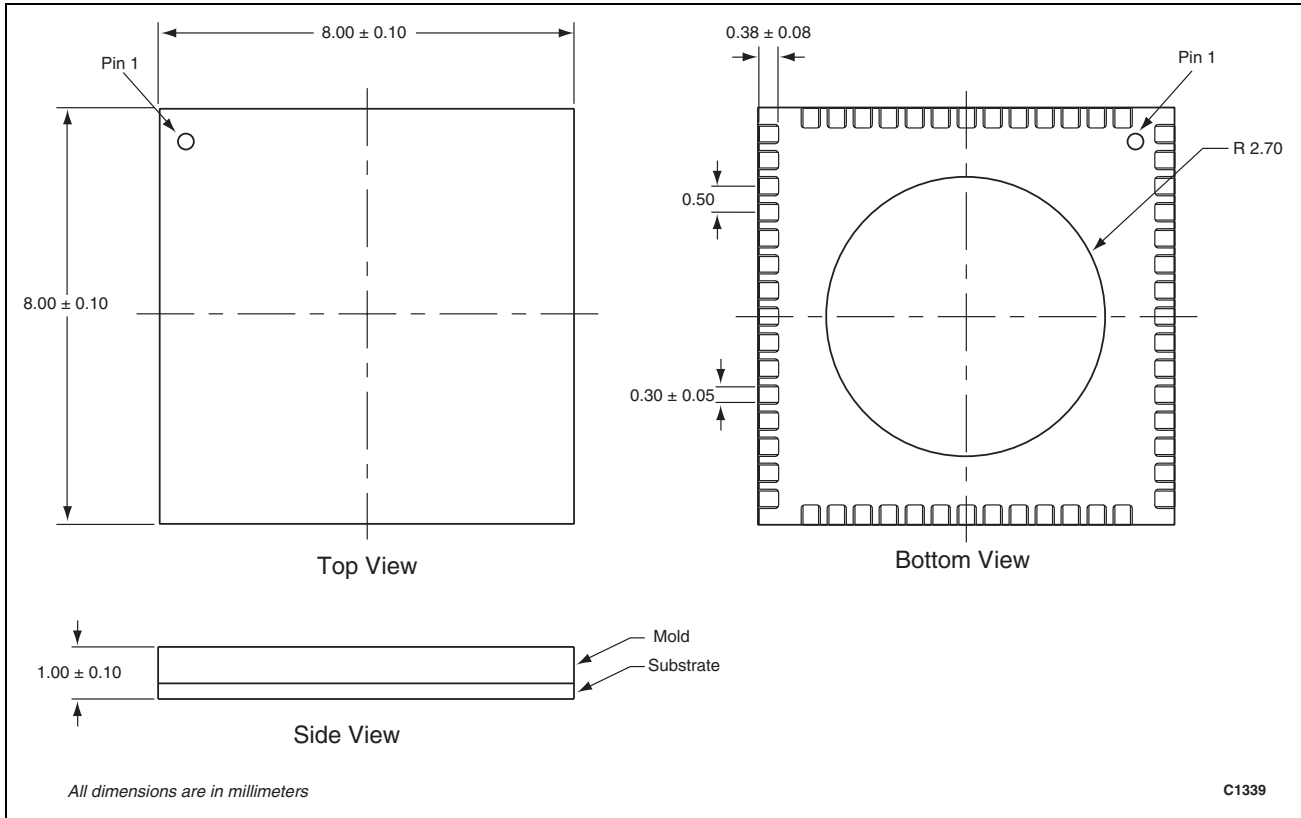

Figure 28. CX74063-26 56-Pin RFLGA Package Dimension Drawing

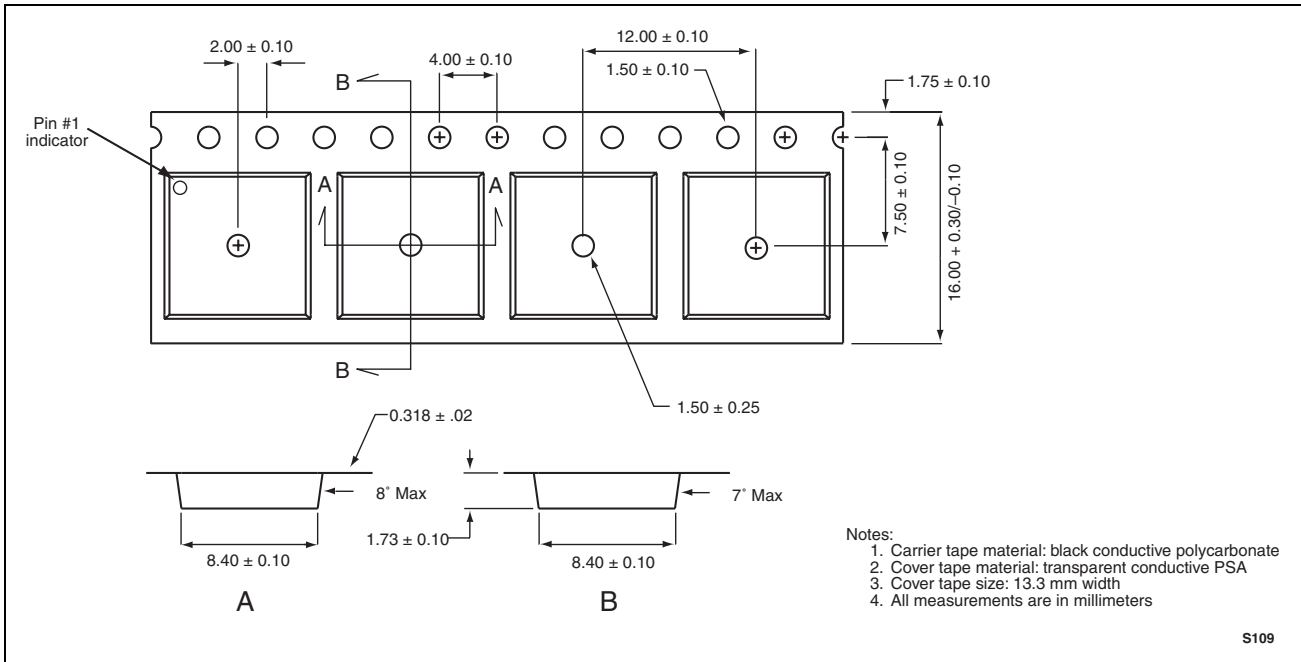

Figure 29. CX74063-26 56-Pin RFLGA Tape and Reel Dimensions

Ordering Information

Model Name	Manufacturing Part Number	Product Revision
CX74063	CX74063-26	

© 2001, 2002, 2003 Skyworks Solutions, Inc. All Rights Reserved.

Information in this document is provided in connection with Skyworks Solutions, Inc. ("Skyworks") products. These materials are provided by Skyworks as a service to its customers and may be used for informational purposes only. Skyworks assumes no responsibility for errors or omissions in these materials. Skyworks may make changes to its products, specifications and product descriptions at any time, without notice. Skyworks makes no commitment to update the information and shall have no responsibility whatsoever for conflicts, incompatibilities, or other difficulties arising from future changes to its products and product descriptions.

No license, express or implied, by estoppel or otherwise, to any intellectual property rights is granted by this document. Except as may be provided in Skyworks' Terms and Conditions of Sale for such products, Skyworks assumes no liability whatsoever.

THESE MATERIALS ARE PROVIDED "AS IS" WITHOUT WARRANTY OF ANY KIND, EITHER EXPRESS OR IMPLIED, RELATING TO SALE AND/OR USE OF SKYWORKS™ PRODUCTS INCLUDING WARRANTIES RELATING TO FITNESS FOR A PARTICULAR PURPOSE, MERCHANTABILITY, PERFORMANCE, QUALITY OR NON-INFRINGEMENT OF ANY PATENT, COPYRIGHT OR OTHER INTELLECTUAL PROPERTY RIGHT. SKYWORKS FURTHER DOES NOT WARRANT THE ACCURACY OR COMPLETENESS OF THE INFORMATION, TEXT, GRAPHICS OR OTHER ITEMS CONTAINED WITHIN THESE MATERIALS. SKYWORKS SHALL NOT BE LIABLE FOR ANY SPECIAL, INDIRECT, INCIDENTAL, OR CONSEQUENTIAL DAMAGES, INCLUDING WITHOUT LIMITATION, LOST REVENUES OR LOST PROFITS THAT MAY RESULT FROM THE USE OF THESE MATERIALS.

Skyworks™ products are not intended for use in medical, lifesaving or life-sustaining applications. Skyworks' customers using or selling Skyworks™ products for use in such applications do so at their own risk and agree to fully indemnify Skyworks for any damages resulting from such improper use or sale.

The following are trademarks of Skyworks Solutions, Inc.: Skyworks™, the Skyworks symbol, "Single Package Radio"™, SPR™, and "Breakthrough Simplicity"™. Product names or services listed in this publication are for identification purposes only, and may be trademarks of third parties. Third-party brands and names are the property of their respective owners.

GSM™, "Global System for Mobile Communications™," and the GSM logo are trademarks of the GSM Association. RFLGA™ is a trademark of Conexant Systems, Inc.

Additional information, posted at www.skyworksin.com, is incorporated by reference.

General Information
Skyworks Solutions, Inc.
20 Sylvan Rd.
Woburn, MA 01801

www.skyworksinc.com

