

April 1995

Features

- 1.25 Micron Radiation Hardened SOS CMOS
- Total Dose 300K RAD (Si)
- Single Event Upset (SEU) Immunity <math><1 \times 10^{-10}</math> Errors/Bit-Day (Typ)
- SEU LET Threshold >80 MEV-cm²/mg
- Dose Rate Upset >10¹¹ RAD (Si)/s, 20ns Pulse
- Latch-Up Free Under Any Conditions
- Military Temperature Range: -55°C to +125°C
- Significant Power Reduction Compared to ALSTTL Logic
- DC Operating Voltage Range: 4.5V to 5.5V
- Input Logic Levels
 - VIL = 0.8V Max
 - VIH = VCC/2 Min
- Input Current ≤1μA at VOL, VOH

Description

The Intersil ACTS08MS is a radiation hardened quad 2-Input AND Gate. A high on both inputs forces the output to a high logic level.

The ACTS08MS utilizes advanced CMOS/SOS technology to achieve high-speed operation. This device is a member of a radiation hardened, high-speed, CMOS/SOS Logic Family.

Pinouts

14 LEAD CERAMIC DUAL-IN-LINE
MIL-STD-1835 DESIGNATOR CDIP2-T14, LEAD FINISH C
TOP VIEW

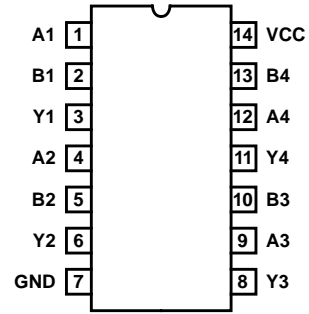

14 LEAD CERAMIC FLAT PACK
MIL-STD-1835 DESIGNATOR CDFP3-F14, LEAD FINISH C
TOP VIEW

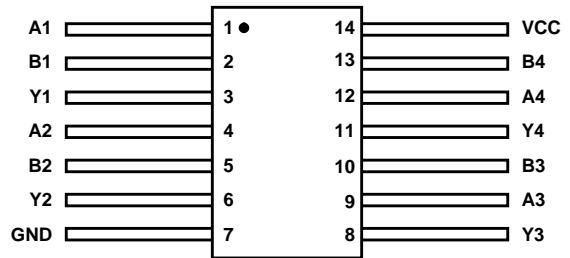

Ordering Information

| PART NUMBER | TEMPERATURE RANGE | SCREENING LEVEL | PACKAGE |
|----------------|-------------------|-----------------------------|--------------------------|
| ACTS08DMSR | -55°C to +125°C | Intersil Class S Equivalent | 14 Lead SBDIP |
| ACTS08KMSR | -55°C to +125°C | Intersil Class S Equivalent | 14 Lead Ceramic Flatpack |
| ACTS08D/Sample | +25°C | Sample | 14 Lead SBDIP |
| ACTS08K/Sample | +25°C | Sample | 14 Lead Ceramic Flatpack |
| ACTS08HMSR | +25°C | Die | Die |

Truth Table

| INPUTS | | OUTPUT |
|--------|----|--------|
| An | Bn | Yn |
| L | L | L |
| L | H | L |
| H | L | L |
| H | H | H |

NOTE: L = Logic Level Low, H = Logic Level High

Functional Diagram

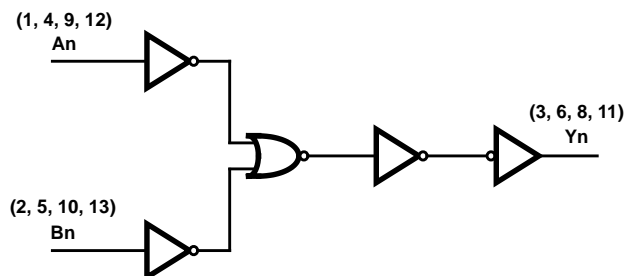

Specifications ACTS08MS

Absolute Maximum Ratings

| | |
|--|--------------------|
| Supply Voltage | -0.5V to +6.0V |
| Input Voltage Range | -0.5V to VCC +0.5V |
| DC Input Current, Any One Input | ±10mA |
| DC Drain Current, Any One Output | ±50mA |
| Storage Temperature Range | -65°C to +150°C |
| Lead Temperature (Soldering 10s) | +265°C |
| Junction Temperature (T _J) | +175°C |
| ESD Classification | Class 1 |

(All voltages reference to VSS)

Reliability Information

| | | |
|---|---------------|---------------|
| Thermal Impedance | θ_{JA} | θ_{JC} |
| DIP | 74°C/W | 24°C/W |
| Flatpack | 116°C/W | 30°C/W |
| Maximum Package Power Dissipation at +125°C | | |
| DIP | 0.7W | |
| Flatpack | 0.4W | |
| Maximum Device Power Dissipation | (TBD)W | |
| Gate Count | 42 Gates | |

CAUTION: As with all semiconductors, stress listed under "Absolute Maximum Ratings" may be applied to devices (one at a time) without resulting in permanent damage. This is a stress rating only. Exposure to absolute maximum rating conditions for extended periods may affect device reliability. The conditions listed under "Electrical Performance Characteristics" are the only conditions recommended for satisfactory device operation.

Operating Conditions

| | | | |
|--|-----------------|--------------------------|---------------|
| Supply Voltage (VCC) | +4.5V to +5.5V | Input Low Voltage (VIL) | 0.0V to 0.8V |
| Input Rise and Fall Times at 4.5V VCC (TR, TF) | 10ns/V Max | Input High Voltage (VIH) | VCC to VCC/2V |
| Operating Temperature Range (T _A) | -55°C to +125°C | | |

TABLE 1. DC ELECTRICAL PERFORMANCE CHARACTERISTICS

| PARAMETER | SYMBOL | (NOTE 1) CONDITIONS | GROUP A SUB- GROUPS | TEMPERATURE | LIMITS | | UNITS |
|-----------------------------------|--------|---|---------------------------|----------------------|----------|------|-------|
| | | | | | MIN | MAX | |
| Supply Current | ICC | VCC = 5.5V, VIN = VCC or GND | 1 | +25°C | - | 5 | μA |
| | | | 2, 3 | +125°C, -55°C | - | 100 | μA |
| Delta ICC | DICC | VCC = 5.5V VIN = VCC or GND 1 Input = 3.4V | 1, 2, 3 | +25°C, +125°C, -55°C | - | 1.6 | mA |
| Output Current (Source) | IOH | VCC = VIH = 4.5V, VOUT = VCC -0.4V, VIL = 0V (Note 2) | 1 | +25°C | -12 | - | mA |
| | | | 2, 3 | +125°C, -55°C | -8 | - | mA |
| Output Current (Sink) | IOL | VCC = VIH = 4.5V, VOUT = 0.4V, VIL = 0V (Note 2) | 1 | +25°C | 12 | - | mA |
| | | | 2, 3 | +125°C, -55°C | 8 | - | mA |
| Output Voltage High | VOH | VCC = 5.5V, VIH = 2.75V, IOH = -50μA, VIL = 0.80V | 1, 2, 3 | +25°C, +125°C, -55°C | VCC -0.1 | - | V |
| | | VCC = 4.5V, VIH = 2.25V, IOH = -50μA, VIL = 0.8V | 1, 2, 3 | +25°C, +125°C, -55°C | VCC -0.1 | - | V |
| Output Voltage Low | VOL | VCC = 5.5V, VIH = 2.75V, IOL = 50μA, VIL = 0.80V | 1, 2, 3 | +25°C, +125°C, -55°C | - | 0.1 | V |
| | | VCC = 4.5V, VIH = 2.25V, IOL = 50μA, VIL = 0.80V | 1, 2, 3 | +25°C, +125°C, -55°C | - | 0.1 | V |
| Input Leakage Current | IIN | VCC = 5.5V, VIN = VCC or GND | 1 | +25°C | - | ±0.5 | μA |
| | | | 2, 3 | +125°C, -55°C | - | ±1.0 | μA |
| Noise Immunity Functional Test | FN | VCC = 4.5V, VIH = 2.25V, VIL = 0.8V (Note 3) | 7, 8A, 8B | +25°C, +125°C, -55°C | - | - | V |

NOTE:

1. All voltages reference to device GND.
2. Force/measure functions may be interchanged.
3. Per functional tests, VO ≥ 4.0V is recognized as a logic "1", and VO ≤ 0.5V is recognized as a logic "0".

Specifications ACTS08MS

TABLE 2. AC ELECTRICAL PERFORMANCE CHARACTERISTICS

| PARAMETER | SYMBOL | (NOTES 1, 2) CONDITIONS | GROUP A SUB- GROUPS | TEMPERATURE | LIMITS | | UNITS |
|--------------------------------------|--------|-------------------------------------|---------------------------|---------------|--------|-----|-------|
| | | | | | MIN | MAX | |
| Propagation Delay Input to Output | TPHL | VCC = 4.5V, VIH = 3.0V, VIL = 0V | 9 | +25°C | 2 | 13 | ns |
| | | | 10, 11 | +125°C, -55°C | 2 | 15 | ns |
| | TPLH | VCC = 4.5V, VIH = 3.0V, VIL = 0V | 9 | +25°C | 2 | 14 | ns |
| | | | 10, 11 | +125°C, -55°C | 2 | 15 | ns |

NOTES:

1. All voltages referenced to device GND.
2. Measurements made with RL = 500Ω, CL = 50pF, Input TR = TF = 3ns.

TABLE 3. ELECTRICAL PERFORMANCE CHARACTERISTICS

| PARAMETER | SYMBOL | CONDITIONS | NOTE | TEMP | LIMITS | | | UNITS |
|----------------------------------|--------|---|------|--------|--------|-----|-----|-------|
| | | | | | MIN | TYP | MAX | |
| Capacitance Power Dissipation | CPD | VCC = 5.0V, VIH = 5.0V, VIL = 0V, f = 1MHz | 1 | +25°C | - | TBD | - | pF |
| | | | 1 | +125°C | - | TBD | - | pF |
| Input Capacitance | CIN | VCC = 5.0V, VIH = 5.0V, VIL = 0V, f = 1MHz | 1 | +25°C | - | - | 10 | pF |
| | | | 1 | +125°C | - | - | 10 | pF |

NOTE:

1. The parameters listed in Table 3 are controlled via design or process parameters. Min and Max Limits are guaranteed but not directly tested. These parameters are characterized upon initial design release and upon design changes which affect these characteristics.

TABLE 4. DC POST RADIATION ELECTRICAL PERFORMANCE CHARACTERISTICS

| PARAMETER | SYMBOL | (NOTES 1, 2) CONDITIONS | TEMPERATURE | RAD LIMITS | | UNITS |
|--------------------------------------|---------------|--|-------------|------------|-----|-------|
| | | | | MIN | MAX | |
| Supply Current | ICC | VCC = 5.5V, VIN = VCC or GND | +25°C | - | 100 | μA |
| Delta ICC | ICC | VCC = 5.5V, VIN = VCC or GND 1 Input = 3.4V | +25°C | - | 1.6 | mA |
| Output Current (Source) | IOH | VCC = VIH = 4.5V, VIL = 0, VOUT = VCC - 0.4V | +25°C | -8 | - | mA |
| Output Current (Sink) | IOL | VCC = VIH = 4.5V, VIL = 0, VOUT = 0.4V | +25°C | 8 | - | mA |
| Output Voltage High | VOH | VCC = 5.5V, VIH = 2.75V, VIL = 0.80V, IOH = -50μA | +25°C | VCC - 0.1 | - | V |
| | | VCC = 4.5V, VIH = 2.25V, VIL = 0.80V, IOH = -50μA | +25°C | VCC - 0.1 | - | V |
| Output Voltage Low | VOL | VCC = 5.5V, VIH = 2.75V, VIL = 0.80V, IOH = 50μA | +25°C | - | 0.1 | V |
| | | VCC = 4.5V, VIH = 2.25V, VIL = 0.80V, IOH = 50μA | +25°C | - | 0.1 | V |
| Input Leakage Current | IIN | VCC = 5.5V, VIN = VCC or GND | +25°C | - | ±1 | μA |
| Noise Immunity Functional Test | FN | VCC = 4.5V, VIH = 2.25V, VIL = 0.80V (Note 2) | +25°C | - | - | V |
| Propagation Delay Input to Output | TPHL, TPLH | VCC = 4.5V, VIH = 3.0V, VIL = 0V | +25°C | 2 | 15 | ns |

NOTES:

1. All voltages referenced to device GND.
2. For functional tests, VO ≥ 4.0V is recognized as a logic "1", and VO ≤ 0.5V is recognized as a logic "0".

Specifications ACTS08MS

TABLE 5. DELTA PARAMETERS (+25°C)

| PARAMETER | SYMBOL | (NOTE 1) DELTA LIMIT | UNITS |
|----------------|---------|-------------------------|-------|
| Supply Current | ICC | ±1.0 | µA |
| Output Current | IOL/IOH | ±15 | % |

NOTE:

- All delta calculations are referenced to 0 hour readings or pre-life readings.

TABLE 6. APPLICABLE SUBGROUPS

| CONFORMANCE GROUP | | METHOD | GROUP A SUBGROUPS | READ AND RECORD |
|------------------------------|--------------|-------------|---------------------------------------|------------------------------|
| Initial Test (Preburn-In) | | 100%/5004 | 1, 7, 9 | ICC, IOL/H |
| Interim Test 1 (Postburn-In) | | 100%/5004 | 1, 7, 9 | ICC, IOL/H |
| Interim Test 2 (Postburn-In) | | 100%/5004 | 1, 7, 9 | ICC, IOL/H |
| PDA | | 100%/5004 | 1, 7, 9, Deltas | |
| Interim Test 3 (Postburn-In) | | 100%/5004 | 1, 7, 9 | ICC, IOL/H |
| PDA | | 100%/5004 | 1, 7, 9, Deltas | |
| Final Test | | 100%/5004 | 2, 3, 8A, 8B, 10, 11 | |
| Group A (Note 1) | | Sample/5005 | 1, 2, 3, 7, 8A, 8B, 9, 10, 11 | |
| Group B | Subgroup B-5 | Sample/5005 | 1, 2, 3, 7, 8A, 8B, 9, 10, 11, Deltas | Subgroups 1, 2, 3, 9, 10, 11 |
| | Subgroup B-6 | Sample/5005 | 1, 7, 9 | |
| Group D | | Sample/5005 | 1, 7, 9 | |

NOTE:

- Alternate Group A testing may be exercised in accordance with MIL-STD-883, Method 5005.

TABLE 7. TOTAL DOSE IRRADIATION

| CONFORMANCE GROUP | METHOD | TEST | | READ AND RECORD | |
|--------------------|--------|---------|----------|-----------------|------------------|
| | | PRE RAD | POST RAD | PRE RAD | POST RAD |
| Group E Subgroup 2 | 5005 | 1, 7, 9 | Table 4 | 1, 9 | Table 4 (Note 1) |

NOTE:

- Except FN test which will be performed 100% Go/No-Go.

TABLE 8. BURN-IN TEST CONNECTIONS (+125°C < TA < 139°C)

| OPEN | GROUND | 1/2 VCC = 3V ±0.5V | VCC = 6V ±0.5V | OSCILLATOR | |
|---|------------------------------|--------------------|-------------------------------|---------------------------|-------|
| | | | | 50kHz | 25kHz |
| STATIC BURN-IN I (Note 1) | | | | | |
| - | 1, 2, 4, 5, 7, 9, 10, 12, 13 | 3, 6, 8, 11 | 14 | - | - |
| STATIC BURN-IN II (Note 1) | | | | | |
| - | 7 | 3, 6, 8, 11 | 1, 2, 4, 5, 9, 10, 12, 13, 14 | - | - |
| DYNAMIC BURN-IN TEST CONNECTIONS (Note 1) | | | | | |
| - | 7 | 3, 6, 8, 11 | 14 | 1, 2, 4, 5, 9, 10, 12, 13 | - |

NOTE:

- Each pin except VCC and GND will have a series resistor of 500Ω ±5%.

TABLE 9. IRRADIATION TEST CONNECTIONS (TA = +25°C, ±5°C)

| FUNCTION | OPEN | GROUND | VCC = 5V ±0.5V |
|------------------------------|-------------|--------|-----------------------------------|
| Irradiation Circuit (Note 1) | 3, 6, 8, 11 | 7 | 1, 2, 4, 5, 9, 10, 11, 12, 13, 14 |

NOTE:

- Each pin except VCC and GND will have a series resistor of 47kΩ ±5%. Group E, Subgroup 2, sample size is 4 dice/wafer, 0 failures.

Specifications ACTS08MS

Intersil - Space Products MS Screening

| | |
|--|---|
| Wafer Lot Acceptance (All Lots) Method 5007 (Includes SEM) | 100% Static Burn-In 2 Method 1015, 24 Hours at +125°C Min |
| Radiation Verification (Each Wafer) Method 1019, 4 Samples/Wafer, 0 Rejects | 100% Interim Electrical Test 2 (Note 1) |
| 100% Nondestructive Bond Pull Method 2023 | 100% Dynamic Burn-In Method 1015, 240 Hours at +125°C or 180 Hours at +135°C |
| 100% Internal Visual Inspection Method 2010 | 100% Interim Electrical Test 3 (Note 1) |
| 100% Temperature Cycling Method 1010 Condition C (-65° to +150°C) | 100% Final Electrical Test |
| 100% Constant Acceleration | 100% Fine and Gross Seal Method 1014 |
| 100% PIND Testing | 100% Radiographics Method 2012 (2 Views) |
| 100% External Visual Inspection | 100% External Visual Method 2009 |
| 100% Serialization | Group A (All Tests) Method 5005 (Class S) |
| 100% Initial Electrical Test | Group B (Optional) Method 5005 (Class S) (Note 2) |
| 100% Static Burn-In 1 Method 1015, 24 Hours at +125°C Min | Group D (Optional) Method 5005 (Class S) (Note 2) |
| 100% Interim Electrical Test 1 (Note 1) | CSI and/or GSI (Optional) (Note 2) |
| | Data Package Generation (Note 3) |

NOTES:

- Failures from interim electrical tests 1 and 2 are combined for determining PDA (PDA = 5% for subgroups 1, 7, 9 and delta failures combined, PDA = 3% for subgroup 7 failures). Interim electrical tests 3 PDA (PDA = 5% for subgroups 1, 7, 9 and delta failures combined, PDA = 3% for subgroup 7 failures).
- These steps are optional, and should be listed on the purchase order if required.
- Data Package Contents:
 Cover Sheet (P.O. Number, Customer Number, Lot Date Code, Intersil Number, Lot Number, Quantity).
 Certificate of Conformance (as found on shipper).
 Lot Serial Number Sheet (Good Unit(s) Serial Number and Lot Number).
 Variables Data (All Read, Record, and delta operations).
 Group A Attributes Data Summary.
 Wafer Lot Acceptance Report (Method 5007) to include reproductions of SEM photos. NOTE: SEM photos to include percent of step coverage.
 X-Ray Report and Film, including penetrometer measurements.
 GAMMA Radiation Report with initial shipment of devices from the same wafer lot; containing a Cover Page, Disposition, RAD Dose, Lot Number, Test Package, Spec Number(s), Test Equipment, etc. Irradiation Read and Record data will be on file at Intersil.

Propagation Delay Timing Diagram and Load Circuit

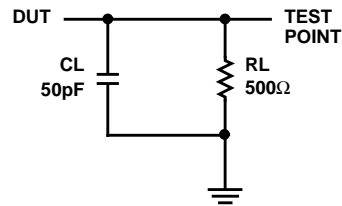
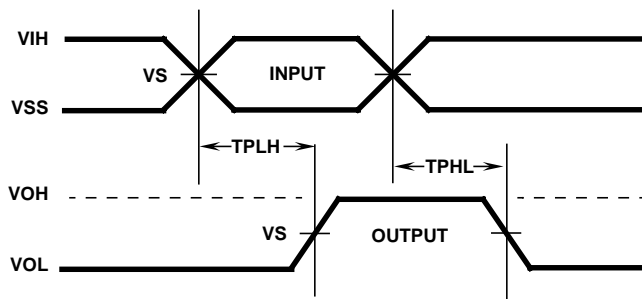

AC VOLTAGE LEVELS

| PARAMETER | ACTS | UNITS |
|-----------|------|-------|
| VCC | 4.50 | V |
| VIH | 3.00 | V |
| VS | 1.30 | V |
| VIL | 0 | V |
| GND | 0 | V |

ACTS08MS

Die Characteristics

DIE DIMENSIONS:

88 mils x 88 mils
2.24mm x 2.24mm

METALLIZATION:

Type: AlSiCu
Metal 1 Thickness: 6.75kÅ (Min), 8.25kÅ (Max)
Metal 2 Thickness: 9kÅ (Min), 11kÅ (Max)

GLASSIVATION:

Type: SiO₂
Thickness: 8kÅ ±1kÅ

DIE ATTACH:

Material: Silver Glass or JM 7000 Polymer after 7/1/95

WORST CASE CURRENT DENSITY:

< 2.0 x 10⁵A/cm²

BOND PAD SIZE:

> 4.3 mils x 4.3 mils
> 110µm x 110µm

Metallization Mask Layout

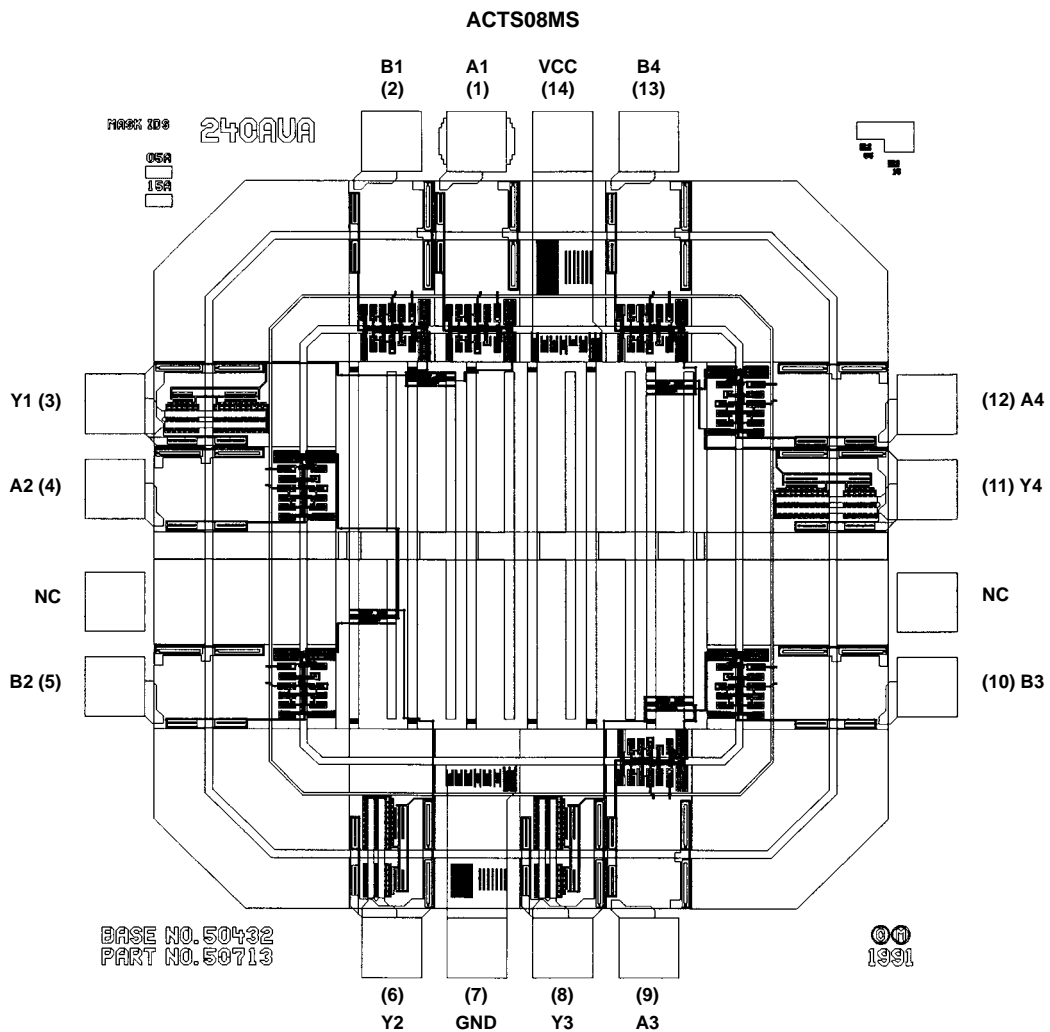

Ceramic Dual-In-Line Metal Seal Packages (SBDIP)

**D14.3 MIL-STD-1835 CDIP2-T14 (D-1, CONFIGURATION C)
14 LEAD CERAMIC DUAL-IN-LINE METAL SEAL PACKAGE**

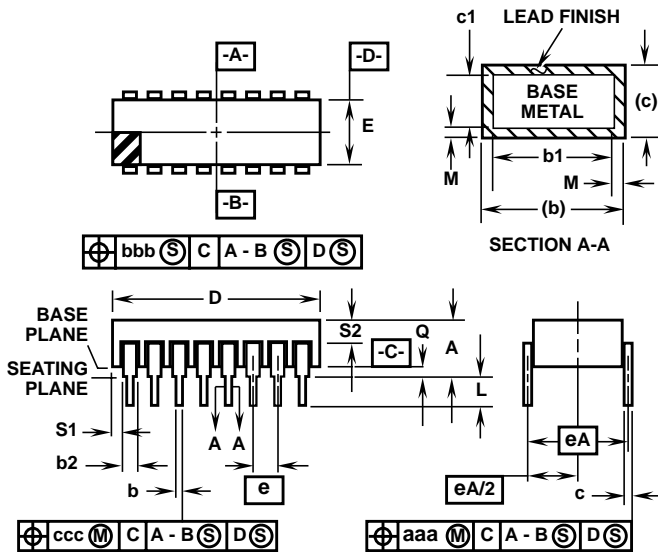

NOTES:

1. Index area: A notch or a pin one identification mark shall be located adjacent to pin one and shall be located within the shaded area shown. The manufacturer's identification shall not be used as a pin one identification mark.
2. The maximum limits of lead dimensions b and c or M shall be measured at the centroid of the finished lead surfaces, when solder dip or tin plate lead finish is applied.
3. Dimensions b1 and c1 apply to lead base metal only. Dimension M applies to lead plating and finish thickness.
4. Corner leads (1, N, N/2, and N/2+1) may be configured with a partial lead paddle. For this configuration dimension b3 replaces dimension b2.
5. Dimension Q shall be measured from the seating plane to the base plane.
6. Measure dimension S1 at all four corners.
7. Measure dimension S2 from the top of the ceramic body to the nearest metallization or lead.
8. N is the maximum number of terminal positions.
9. Braze fillets shall be concave.
10. Dimensioning and tolerancing per ANSI Y14.5M - 1982.
11. Controlling dimension: INCH.

| SYMBOL | INCHES | | MILLIMETERS | | NOTES |
|----------|-----------|--------|-------------|-------|-------|
| | MIN | MAX | MIN | MAX | |
| A | - | 0.200 | - | 5.08 | - |
| b | 0.014 | 0.026 | 0.36 | 0.66 | 2 |
| b1 | 0.014 | 0.023 | 0.36 | 0.58 | 3 |
| b2 | 0.045 | 0.065 | 1.14 | 1.65 | - |
| b3 | 0.023 | 0.045 | 0.58 | 1.14 | 4 |
| c | 0.008 | 0.018 | 0.20 | 0.46 | 2 |
| c1 | 0.008 | 0.015 | 0.20 | 0.38 | 3 |
| D | - | 0.785 | - | 19.94 | - |
| E | 0.220 | 0.310 | 5.59 | 7.87 | - |
| e | 0.100 BSC | | 2.54 BSC | | - |
| eA | 0.300 BSC | | 7.62 BSC | | - |
| eA/2 | 0.150 BSC | | 3.81 BSC | | - |
| L | 0.125 | 0.200 | 3.18 | 5.08 | - |
| Q | 0.015 | 0.060 | 0.38 | 1.52 | 5 |
| S1 | 0.005 | - | 0.13 | - | 6 |
| S2 | 0.005 | - | 0.13 | - | 7 |
| α | 90° | 105° | 90° | 105° | - |
| aaa | - | 0.015 | - | 0.38 | - |
| bbb | - | 0.030 | - | 0.76 | - |
| ccc | - | 0.010 | - | 0.25 | - |
| M | - | 0.0015 | - | 0.038 | 2 |
| N | 14 | | 14 | | 8 |

Rev. 0 4/94

Ceramic Metal Seal Flatpack Packages (Flatpack)

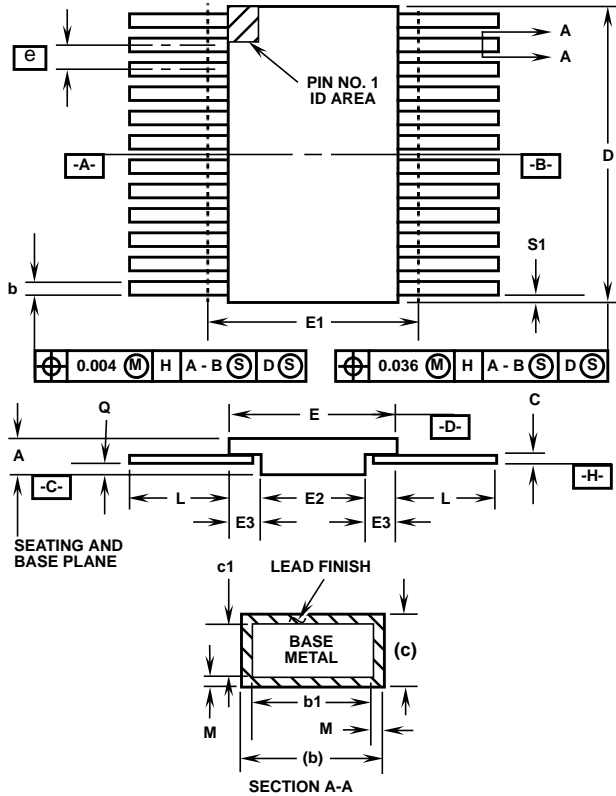

**K14.A MIL-STD-1835 CDFP3-F14 (F-2A, CONFIGURATION B)
14 LEAD CERAMIC METAL SEAL FLATPACK PACKAGE**

| SYMBOL | INCHES | | MILLIMETERS | | NOTES |
|--------|-----------|--------|-------------|------|-------|
| | MIN | MAX | MIN | MAX | |
| A | 0.045 | 0.115 | 1.14 | 2.92 | - |
| b | 0.015 | 0.022 | 0.38 | 0.56 | - |
| b1 | 0.015 | 0.019 | 0.38 | 0.48 | - |
| c | 0.004 | 0.009 | 0.10 | 0.23 | - |
| c1 | 0.004 | 0.006 | 0.10 | 0.15 | - |
| D | - | 0.390 | - | 9.91 | 3 |
| E | 0.235 | 0.260 | 5.97 | 6.60 | - |
| E1 | - | 0.290 | - | 7.11 | 3 |
| E2 | 0.125 | - | 3.18 | - | - |
| E3 | 0.030 | - | 0.76 | - | 7 |
| e | 0.050 BSC | | 1.27 BSC | | - |
| k | 0.008 | 0.015 | 0.20 | 0.38 | 2 |
| L | 0.270 | 0.370 | 6.86 | 9.40 | - |
| Q | 0.026 | 0.045 | 0.66 | 1.14 | 8 |
| S1 | 0.005 | - | 0.13 | - | 6 |
| M | - | 0.0015 | - | 0.04 | - |
| N | 14 | | 14 | | - |

Rev. 0 5/18/94

NOTES:

1. Index area: A notch or a pin one identification mark shall be located adjacent to pin one and shall be located within the shaded area shown. The manufacturer's identification shall not be used as a pin one identification mark. Alternately, a tab (dimension k) may be used to identify pin one.
2. If a pin one identification mark is used in addition to a tab, the limits of dimension k do not apply.
3. This dimension allows for off-center lid, meniscus, and glass overrun.
4. Dimensions b1 and c1 apply to lead base metal only. Dimension M applies to lead plating and finish thickness. The maximum limits of lead dimensions b and c or M shall be measured at the centroid of the finished lead surfaces, when solder dip or tin plate lead finish is applied.
5. N is the maximum number of terminal positions.
6. Measure dimension S1 at all four corners.
7. For bottom-brazed lead packages, no organic or polymeric materials shall be molded to the bottom of the package to cover the leads.
8. Dimension Q shall be measured at the point of exit (beyond the meniscus) of the lead from the body. Dimension Q minimum shall be reduced by 0.0015 inch (0.038mm) maximum when solder dip lead finish is applied.
9. Dimensioning and tolerancing per ANSI Y14.5M - 1982.
10. Controlling dimension: INCH.

All Intersil semiconductor products are manufactured, assembled and tested under **ISO9000** quality systems certification.

Intersil products are sold by description only. Intersil Corporation reserves the right to make changes in circuit design and/or specifications at any time without notice. Accordingly, the reader is cautioned to verify that data sheets are current before placing orders. Information furnished by Intersil is believed to be accurate and reliable. However, no responsibility is assumed by Intersil or its subsidiaries for its use; nor for any infringements of patents or other rights of third parties which may result from its use. No license is granted by implication or otherwise under any patent or patent rights of Intersil or its subsidiaries.

For information regarding Intersil Corporation and its products, see web site <http://www.intersil.com>

Sales Office Headquarters

NORTH AMERICA
Intersil Corporation
P. O. Box 883, Mail Stop 53-204
Melbourne, FL 32902
TEL: (321) 724-7000
FAX: (321) 724-7240

EUROPE
Intersil SA
Mercure Center
100, Rue de la Fusee
1130 Brussels, Belgium
TEL: (32) 2.724.2111
FAX: (32) 2.724.22.05

ASIA
Intersil (Taiwan) Ltd.
Taiwan Limited
7F-6, No. 101 Fu Hsing North Road
Taipei, Taiwan
Republic of China
TEL: (886) 2 2716 9310
FAX: (886) 2 2715 3029