

## 3 V, 2.9 GHz SILICON MMIC MEDIUM OUTPUT POWER AMPLIFIER FOR MOBILE COMMUNICATIONS

### DESCRIPTION

The μPC8182TB is a silicon monolithic integrated circuit designed as amplifier for mobile communications. This IC operates at 3 V. The medium output power is suitable for RF-TX of mobile communications system.

This IC is manufactured using our 30 GHz  $f_{max}$  UHS0 (Ultra High Speed Process) silicon bipolar process. This process uses direct silicon nitride passivation film and gold electrodes. These materials can protect the chip surface from pollution and prevent corrosion/migration. Thus, this IC has excellent performance, uniformity and reliability.

### FEATURES

- Supply voltage:  $V_{CC} = 2.7$  to  $3.3$  V
- Circuit current:  $I_{CC} = 30$  mA TYP. @  $V_{CC} = 3.0$  V
- Medium output power:  $P_{O(1dB)} = +9.5$  dBm TYP. @  $f = 0.9$  GHz  
 $P_{O(1dB)} = +9.0$  dBm TYP. @  $f = 1.9$  GHz  
 $P_{O(1dB)} = +8.0$  dBm TYP. @  $f = 2.4$  GHz
- Power gain:  $G_P = 21.5$  dB TYP. @  $f = 0.9$  GHz  
 $G_P = 20.5$  dB TYP. @  $f = 1.9$  GHz  
 $G_P = 20.5$  dB TYP. @  $f = 2.4$  GHz
- Upper limit operating frequency:  $f_u = 2.9$  GHz TYP. @ 3 dB bandwidth
- High-density surface mounting: 6-pin super minimold package ( $2.0 \times 1.25 \times 0.9$  mm)

### APPLICATION

- Buffer amplifiers on 1.9 to 2.4 GHz mobile communications system

### ORDERING INFORMATION (Solder Contains Lead)

Part Number	Package	Marking	Supplying Form
μPC8182TB-E3	6-pin super minimold	C3F	<ul style="list-style-type: none"> <li>• Embossed tape 8 mm wide</li> <li>• Pin 1, 2, 3 face the perforation side of the tape</li> <li>• Qty 3 kpcs/reel</li> </ul>

**Remark** To order evaluation samples, contact you're nearby sales office. Part number for sample order:  
μPC8182TB

### ORDERING INFORMATION (Pb-Free)

Part Number	Package	Marking	Supplying Form
μPC8182TB-E3-AZ*	6-pin super minimold	C3F	<ul style="list-style-type: none"> <li>• Embossed tape 8 mm wide</li> <li>• Pin 1, 2, 3 face the perforation side of the tape</li> <li>• Qty 3 kpcs/reel</li> </ul>

**\*NOTE:** Please refer to the last page of this data sheet, "Compliance with EU Directives" for Pb-Free RoHS Compliance Information.

The information in this document is subject to change without notice. Before using this document, please confirm that this is the latest version.

**PIN CONNECTIONS**

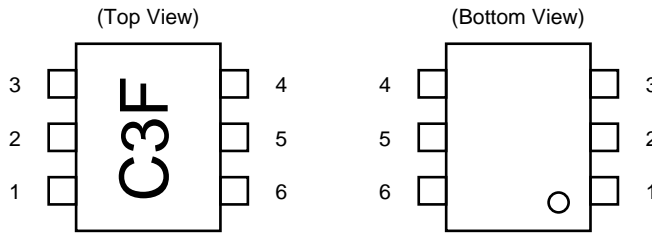

Pin No.	Pin Name
1	INPUT
2	GND
3	GND
4	OUTPUT
5	GND
6	V <sub>cc</sub>

**PRODUCT LINE-UP (T<sub>A</sub> = +25°C, V<sub>cc</sub> = V<sub>out</sub> = 3.0 V, Z<sub>s</sub> = Z<sub>L</sub> = 50 Ω)**

Part No.	f <sub>u</sub> (GHz)	P <sub>O</sub> (1 dB) (dBm)	G <sub>P</sub> (dB)	I <sub>cc</sub> (mA)	Package	Marking
$\mu$ PC8182TB	2.9	+9.5 @ f = 0.9 GHz +9.0 @ f = 1.9 GHz +8.0 @ f = 2.4 GHz	21.5 @ f = 0.9 GHz 20.5 @ f = 1.9 GHz 20.5 @ f = 2.4 GHz	30.0	6-pin super minimold	C3F
$\mu$ PC2762T	2.9	+8.0 @ f = 0.9 GHz	13.0 @ f = 0.9 GHz	26.5	6-pin minimold	C1Z
$\mu$ PC2762TB		+7.0 @ f = 1.9 GHz	15.5 @ f = 1.9 GHz		6-pin super minimold	
$\mu$ PC2763T	2.7	+9.5 @ f = 0.9 GHz	20.0 @ f = 0.9 GHz	27.0	6-pin minimold	C2A
$\mu$ PC2763TB		+6.5 @ f = 1.9 GHz	21.0 @ f = 1.9 GHz		6-pin super minimold	
$\mu$ PC2771T	2.2	+11.5 @ f = 0.9 GHz	21.0 @ f = 0.9 GHz	36.0	6-pin minimold	C2H
$\mu$ PC2771TB		+9.5 @ f = 1.5 GHz	21.0 @ f = 1.5 GHz		6-pin super minimold	
★ $\mu$ PC8181TB	4.0	+8.0 @ f = 0.9 GHz +7.0 @ f = 1.9 GHz +7.0 @ f = 2.4 GHz	19.0 @ f = 0.9 GHz 21.0 @ f = 1.9 GHz 22.0 @ f = 2.4 GHz	23.0	6-pin super minimold	C3E

**Remark** Typical performance. Please refer to ELECTRICAL CHARACTERISTICS in detail.

**Caution** The package size distinguishes between minimold and super minimold.

**SYSTEM APPLICATION EXAMPLE**

**Digital cellular telephone**

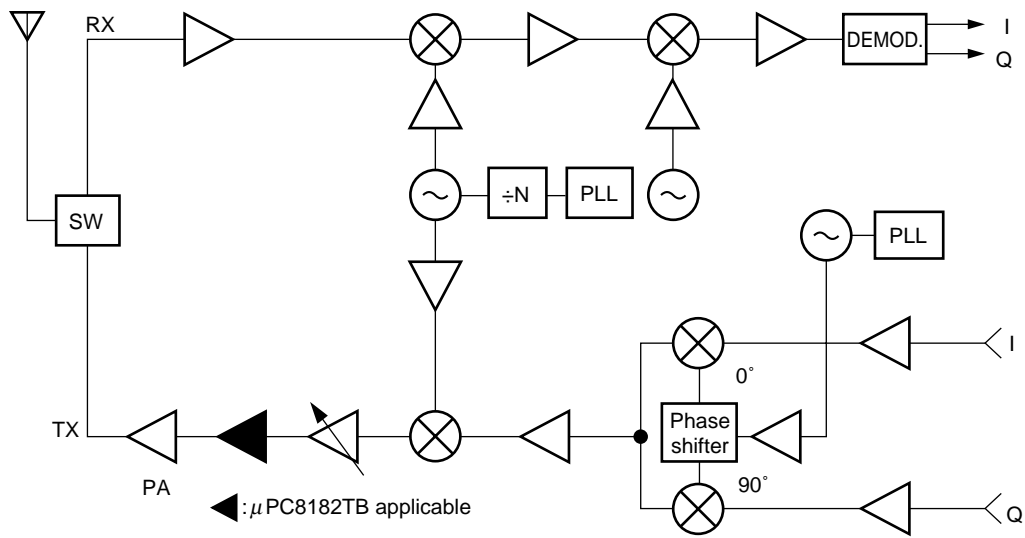

**Caution** The insertion point is different due to the specifications of conjunct devices.

**PIN EXPLANATION**

Pin No.	Pin Name	Applied Voltage (V)	Pin Voltage (V) <small>Note</small>	Function and Applications	Internal Equivalent Circuit
1	INPUT	–	0.99	Signal input pin. A internal matching circuit, configured with resistors, enables 50 $\Omega$ connection over a wide band. A multi-feedback circuit is designed to cancel the deviations of $h_{FE}$ and resistance. This pin must be coupled to signal source with capacitor for DC cut.	
4	OUTPUT	Voltage as same as $V_{CC}$ through external inductor	–	Signal output pin. The inductor must be attached between $V_{CC}$ and output pins to supply current to the internal output transistors.	
6	$V_{CC}$	2.7 to 3.3	–	Power supply pin, which biases the internal input transistor. This pin should be externally equipped with bypass capacitor to minimize its impedance.	
2 3 5	GND	0	–	Ground pin. This pin should be connected to system ground with minimum inductance. Ground pattern on the board should be formed as wide as possible. All the ground pins must be connected together with wide ground pattern to decrease impedance difference.	

**Note** Pin voltage is measured at  $V_{CC} = 3.0$  V.

**ABSOLUTE MAXIMUM RATINGS**

Parameter	Symbol	Test Conditions	Ratings	Unit
Supply Voltage	V <sub>CC</sub>	T <sub>A</sub> = +25°C, pin 4 and pin 6	3.6	V
Total Circuit Current	I <sub>CC</sub>	T <sub>A</sub> = +25°C	60	mA
Power Dissipation	P <sub>D</sub>	T <sub>A</sub> = +85°C <b>Note</b>	270	mW
Operating Ambient Temperature	T <sub>A</sub>		-40 to +85	°C
Storage Temperature	T <sub>stg</sub>		-55 to +150	°C
Input Power	P <sub>in</sub>	T <sub>A</sub> = +25°C	+10	dBm

**Note** Mounted on double-sided copper-clad 50 × 50 × 1.6 mm epoxy glass PWB

**RECOMMENDED OPERATING RANGE**

Parameter	Symbol	MIN.	TYP.	MAX.	Unit	Remarks
Supply Voltage	V <sub>CC</sub>	2.7	3.0	3.3	V	Same voltage should be applied to pin 4 and pin 6.
Operating Ambient Temperature	T <sub>A</sub>	-40	+25	+85	°C	-

**ELECTRICAL CHARACTERISTICS**

( $T_A = +25^\circ\text{C}$ ,  $V_{CC} = V_{out} = 3.0\text{ V}$ ,  $Z_s = Z_L = 50\ \Omega$ , unless otherwise specified)

Parameter	Symbol	Test Conditions	MIN.	TYP.	MAX.	Unit
Circuit Current	$I_{CC}$	No signal	–	30.0	38.0	mA
Power Gain	$G_P$	f = 0.9 GHz f = 1.9 GHz f = 2.4 GHz	19.0 18.0 18.0	21.5 20.5 20.5	25.0 24.0 24.0	dB
Noise Figure	NF	f = 0.9 GHz f = 1.9 GHz f = 2.4 GHz	– – –	4.5 4.5 5.0	6.0 6.0 6.5	dB
Upper Limit Operating Frequency	$f_u$	3 dB down below from gain at f = 0.1 GHz	2.6	2.9	–	GHz
Isolation	ISL	f = 0.9 GHz f = 1.9 GHz f = 2.4 GHz	28 27 26	33 32 31	– – –	dB
Input Return Loss	$RL_{in}$	f = 0.9 GHz f = 1.9 GHz f = 2.4 GHz	5 7 9	8 10 12	– – –	dB
Output Return Loss	$RL_{out}$	f = 0.9 GHz f = 1.9 GHz f = 2.4 GHz	7 8 11	10 11 14	– – –	dB
Gain 1 dB Compression Output Power	$P_{O(1dB)}$	f = 0.9 GHz f = 1.9 GHz f = 2.4 GHz	+7.0 +6.5 +5.5	+9.5 +9.0 +8.0	– – –	dBm
Saturated Output Power	$P_{O(sat)}$	f = 0.9 GHz, $P_{in} = -5\text{ dBm}$ f = 1.9 GHz, $P_{in} = -5\text{ dBm}$ f = 2.4 GHz, $P_{in} = -5\text{ dBm}$	– – –	+11.0 +10.5 +10.0	– – –	dBm

**TEST CIRCUITS**

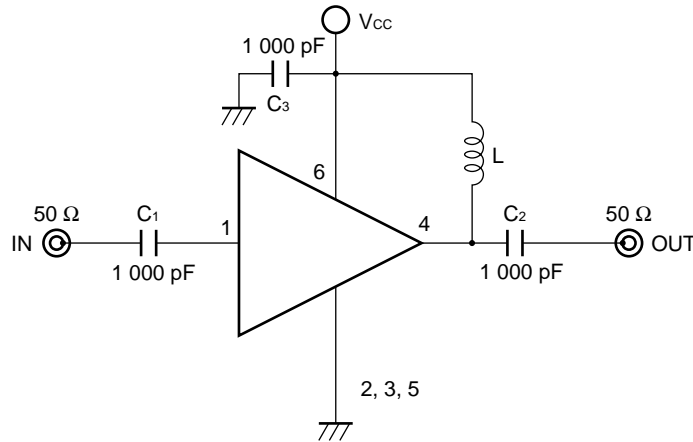

**COMPONENTS OF TEST CIRCUIT FOR MEASURING ELECTRICAL CHARACTERISTICS**

	Type	Value
C <sub>1</sub> , C <sub>2</sub>	Bias Tee	1 000 pF
C <sub>3</sub>	Capacitor	1 000 pF
L	Bias Tee	1 000 nH

**EXAMPLE OF ACTUAL APPLICATION COMPONENTS**

	Type	Value	Operating Frequency
C <sub>1</sub> to C <sub>3</sub>	Chip capacitor	1 000 pF	100 MHz or higher
L	Chip inductor	100 nH	100 MHz or higher
		10 nH	2.0 GHz or higher

**INDUCTOR FOR THE OUTPUT PIN**

The internal output transistor of this IC consumes 20 mA, to output medium power. To supply current for output transistor, connect an inductor between the Vcc pin (pin 6) and output pin (pin 4). Select large value inductance, as listed above.

The inductor has both DC and AC effects. In terms of DC, the inductor biases the output transistor with minimum voltage drop to output enable high level. In terms of AC, the inductor makes output-port-impedance higher to get enough gain. In this case, large inductance and Q is suitable.

For above reason, select an inductance of 100 Ω or over impedance in the operating frequency. The gain is a peak in the operating frequency band, and suppressed at lower frequencies.

The recommendable inductance can be chosen from example of actual application components list as shown above.

**CAPACITORS FOR THE VCC, INPUT, AND OUTPUT PINS**

Capacitors of 1 000 pF are recommendable as the bypass capacitor for the Vcc pin and the coupling capacitors for the input and output pins.

The bypass capacitor connected to the Vcc pin is used to minimize ground impedance of Vcc pin. So, stable bias can be supplied against Vcc fluctuation.

The coupling capacitors, connected to the input and output pins, are used to cut the DC and minimize RF serial impedance. Their capacitance are therefore selected as lower impedance against a 50 Ω load. The capacitors thus perform as high pass filters, suppressing low frequencies to DC.

To obtain a flat gain from 100 MHz upwards, 1 000 pF capacitors are used in the test circuit. In the case of under 10 MHz operation, increase the value of coupling capacitor such as 10 000 pF. Because the coupling capacitors are determined by equation,  $C = 1/(2\pi Rfc)$ .

ILLUSTRATION OF THE TEST CIRCUIT ASSEMBLED ON EVALUATION BOARD

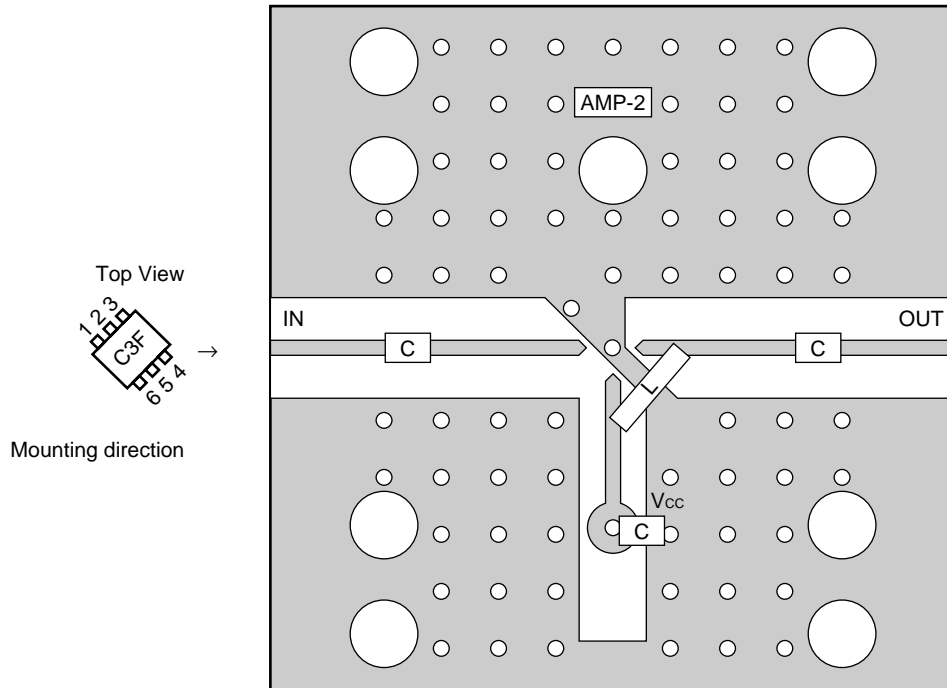

COMPONENT LIST

	Value
C	1 000 pF
L	Example: 10 nH

Notes

1. 30 × 30 × 0.4 mm double-sided copper-clad polyimide board.
2. Back side: GND pattern
3. Solder plated on pattern
4. ○ ○ : Through holes



TYPICAL CHARACTERISTICS ( $T_A = +25^\circ\text{C}$ , unless otherwise specified)

CIRCUIT CURRENT vs. SUPPLY VOLTAGE

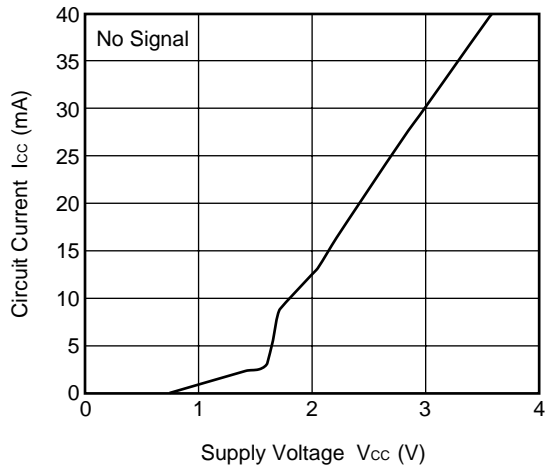

CIRCUIT CURRENT vs. OPERATING AMBIENT TEMPERATURE

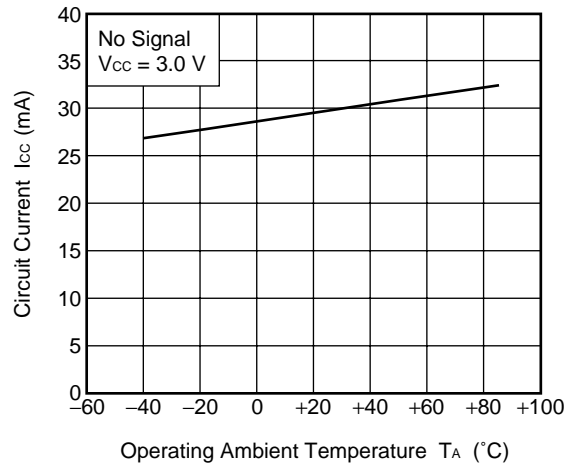

NOISE FIGURE, POWER GAIN vs. FREQUENCY

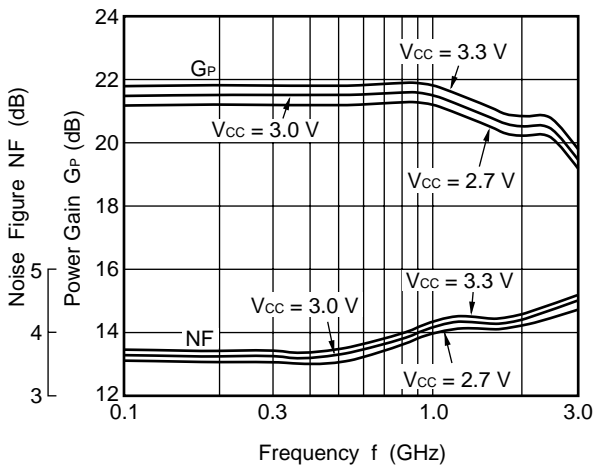

POWER GAIN vs. FREQUENCY

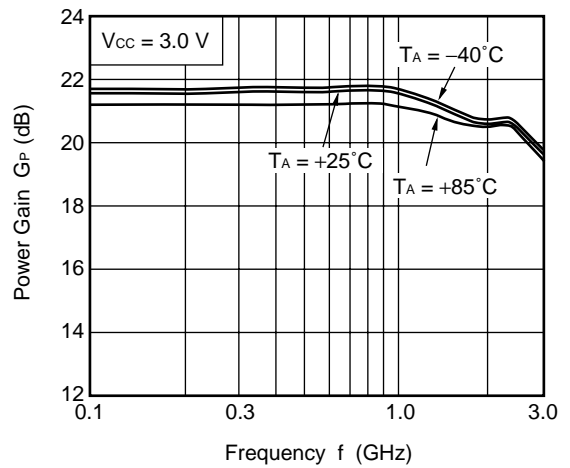

ISOLATION vs. FREQUENCY

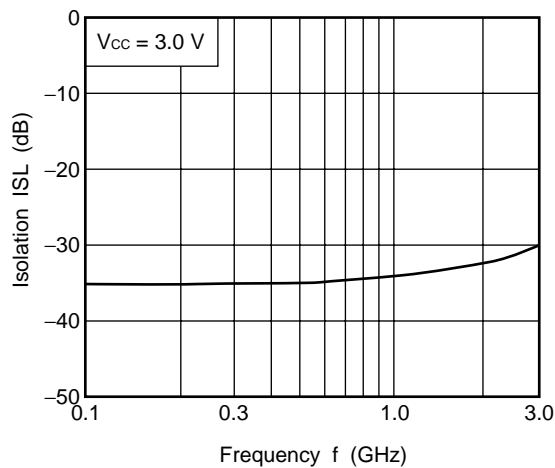

INPUT RETURN LOSS, OUTPUT RETURN LOSS vs. FREQUENCY

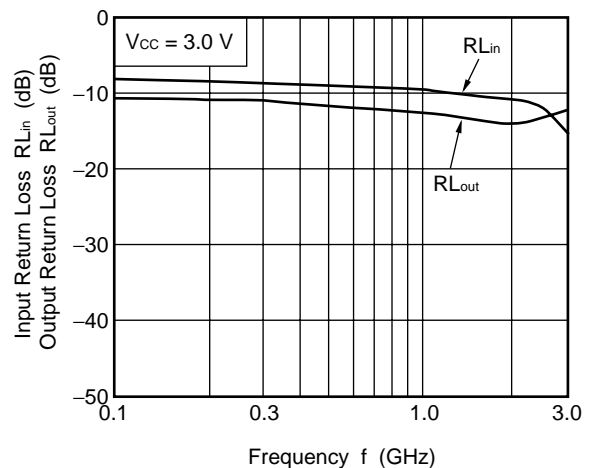

OUTPUT POWER vs. INPUT POWER

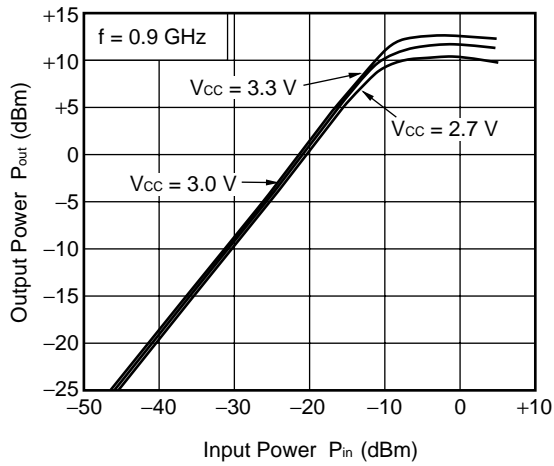

OUTPUT POWER vs. INPUT POWER

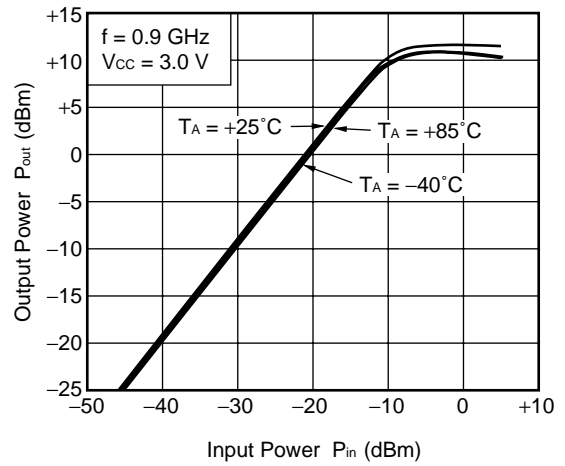

OUTPUT POWER vs. INPUT POWER

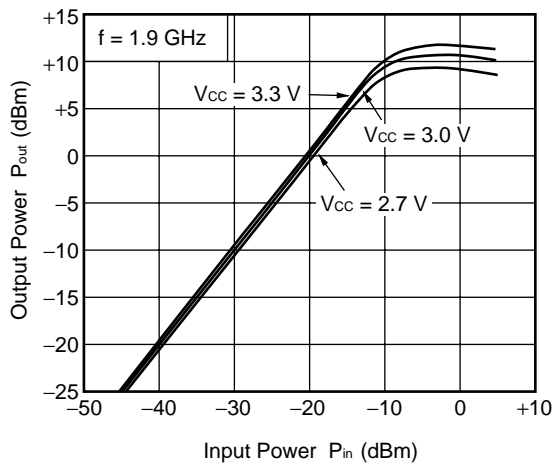

OUTPUT POWER vs. INPUT POWER

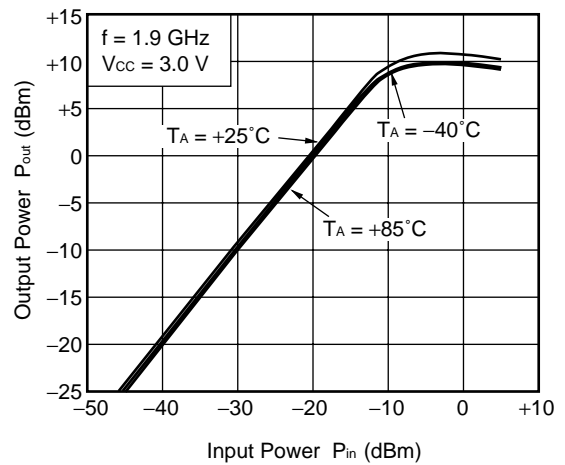

OUTPUT POWER vs. INPUT POWER

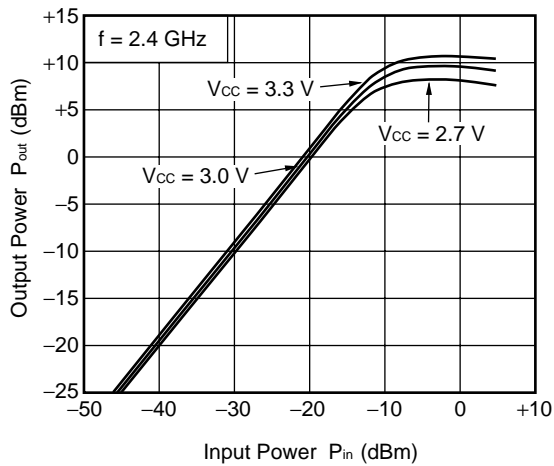

OUTPUT POWER vs. INPUT POWER

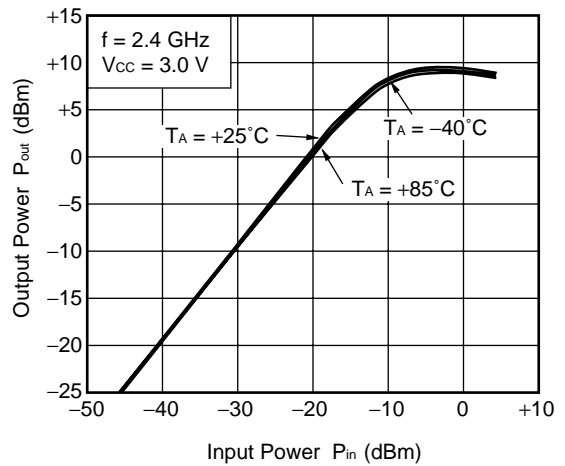

★

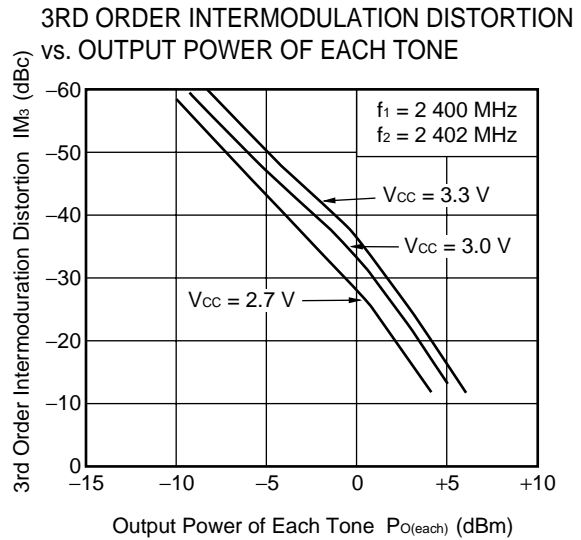
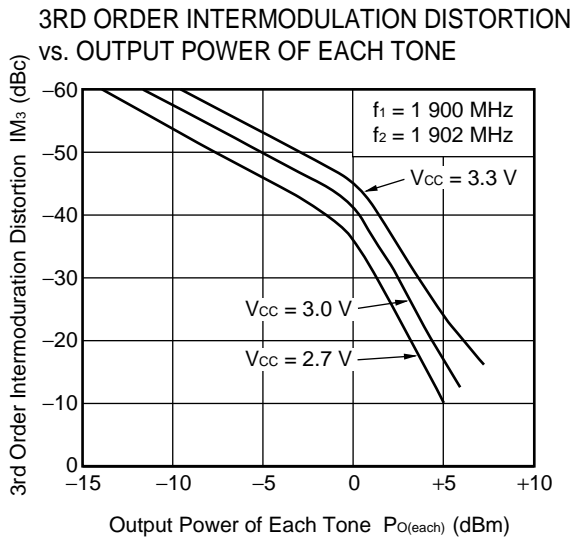
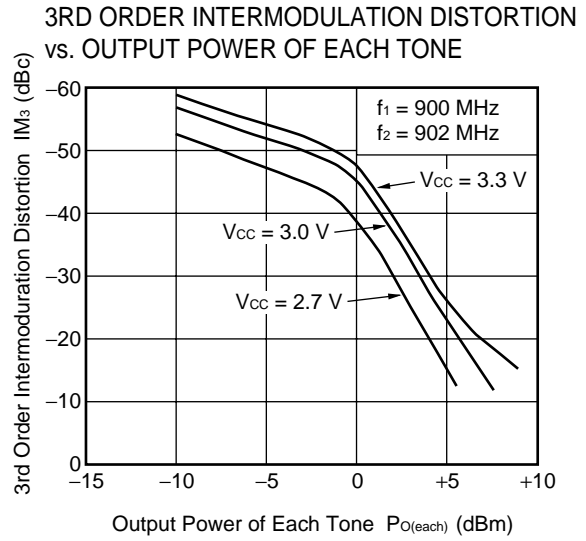
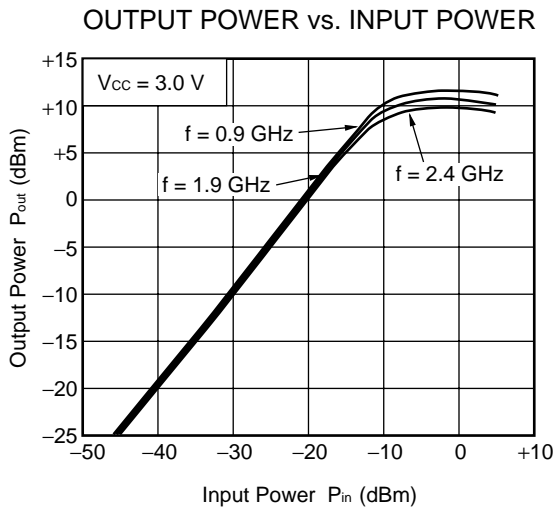

**Remark** The graphs indicate nominal characteristics.

SMITH CHART ( $V_{CC} = V_{out} = 3.0\text{ V}$ )

S<sub>11</sub>-FREQUENCY

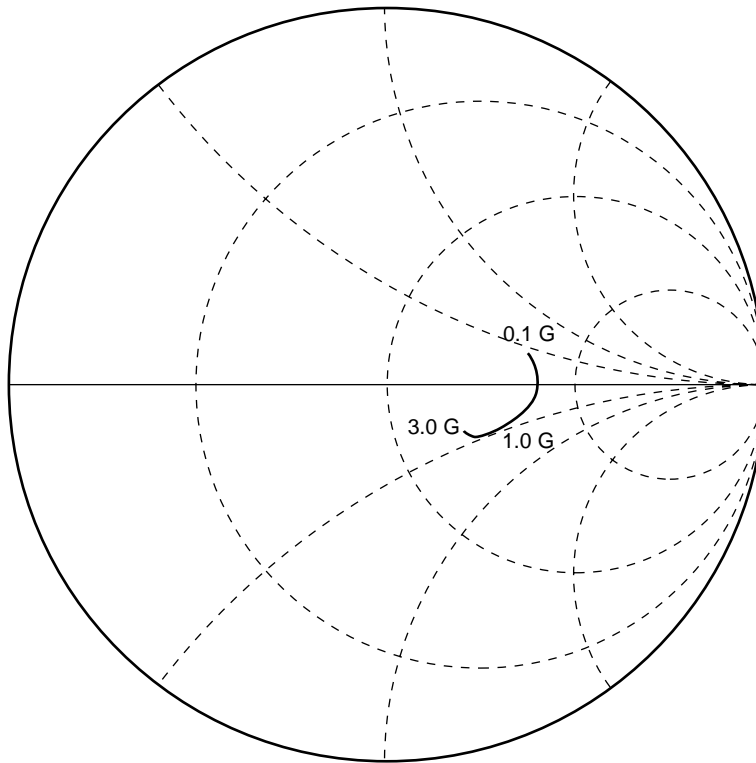

S<sub>22</sub>-FREQUENCY

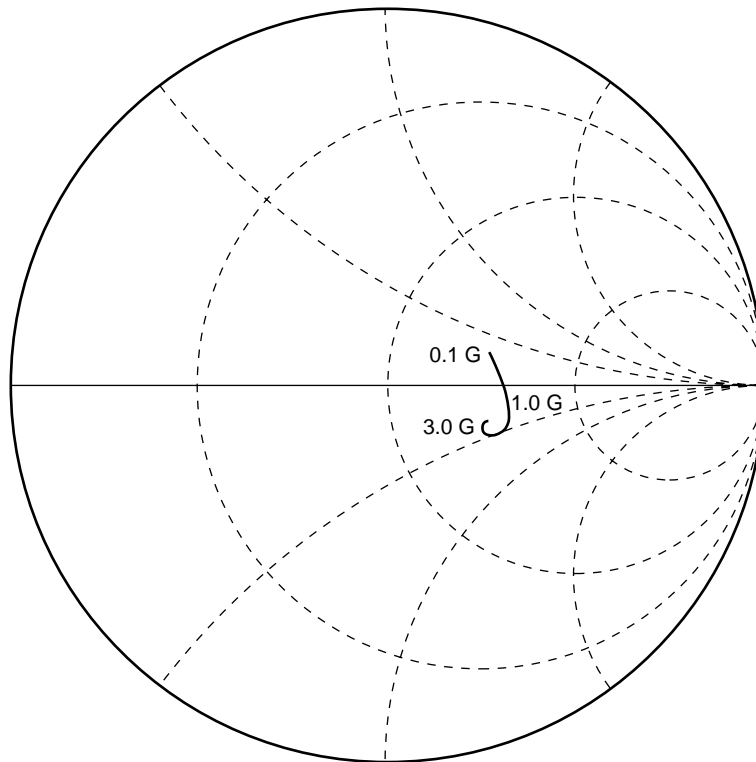

**★ S-PARAMETERS**

S-parameters/Noise parameters are provided on the NEC Compound Semiconductor Devices Web site in a form (S2P) that enables direct import to a microwave circuit simulator without keyboard input.

Click here to download S-parameters.

[RF and Microwave] → [Device Parameters]

URL <http://www.csd-nec.com/>

PACKAGE DIMENSIONS

6-PIN SUPER MINIMOLD (UNIT: mm)

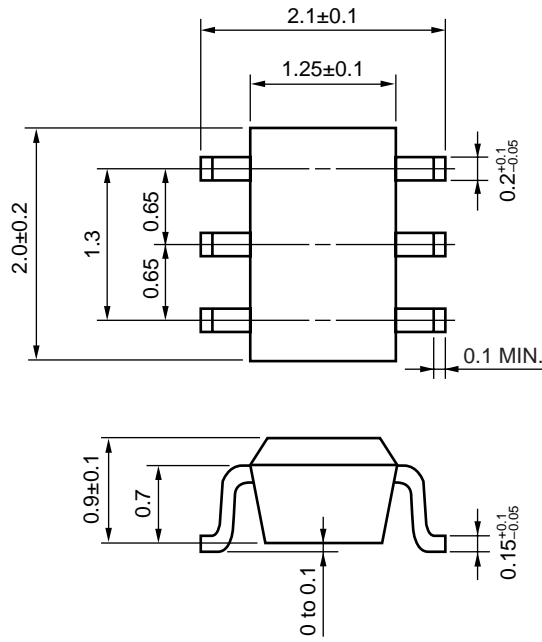

**NOTES ON CORRECT USE**

- (1) Observe precautions for handling because of electro-static sensitive devices.
- (2) Form a ground pattern as widely as possible to minimize ground impedance (to prevent undesired oscillation).  
All the ground pins must be connected together with wide ground pattern to decrease impedance difference.
- (3) The bypass capacitor should be attached to the Vcc pin.
- (4) The inductor must be attached between Vcc and output pins. The inductance value should be determined in accordance with desired frequency.
- (5) The DC cut capacitor must be attached to input and output pin.

**RECOMMENDED SOLDERING CONDITIONS**

This product should be soldered and mounted under the following recommended conditions. For soldering methods and conditions other than those recommended below, contact your nearby sales office.

Soldering Method	Soldering Conditions	Condition Symbol
Infrared Reflow	Peak temperature (package surface temperature) : 260°C or below Time at peak temperature : 10 seconds or less Time at temperature of 220°C or higher : 60 seconds or less Preheating time at 120 to 180°C : 120±30 seconds Maximum number of reflow processes : 3 times Maximum chlorine content of rosin flux (% mass) : 0.2%(Wt.) or below	IR260
VPS	Peak temperature (package surface temperature) : 215°C or below Time at temperature of 200°C or higher : 25 to 40 seconds Preheating time at 120 to 150°C : 30 to 60 seconds Maximum number of reflow processes : 3 times Maximum chlorine content of rosin flux (% mass) : 0.2%(Wt.) or below	VP215
Wave Soldering	Peak temperature (molten solder temperature) : 260°C or below Time at peak temperature : 10 seconds or less Preheating temperature (package surface temperature) : 120°C or below Maximum number of flow processes : 1 time Maximum chlorine content of rosin flux (% mass) : 0.2%(Wt.) or below	WS260
Partial Heating	Peak temperature (pin temperature) : 350°C or below Soldering time (per side of device) : 3 seconds or less Maximum chlorine content of rosin flux (% mass) : 0.2%(Wt.) or below	HS350

**Caution Do not use different soldering methods together (except for partial heating).**

Subject: Compliance with EU Directives

CEL certifies, to its knowledge, that semiconductor and laser products detailed below are compliant with the requirements of European Union (EU) Directive 2002/95/EC Restriction on Use of Hazardous Substances in electrical and electronic equipment (RoHS) and the requirements of EU Directive 2003/11/EC Restriction on Penta and Octa BDE.

CEL Pb-free products have the same base part number with a suffix added. The suffix –A indicates that the device is Pb-free. The –AZ suffix is used to designate devices containing Pb which are exempted from the requirement of RoHS directive (\*). In all cases the devices have Pb-free terminals. All devices with these suffixes meet the requirements of the RoHS directive.

This status is based on CEL’s understanding of the EU Directives and knowledge of the materials that go into its products as of the date of disclosure of this information.

Restricted Substance per RoHS	Concentration Limit per RoHS (values are not yet fixed)	Concentration contained in CEL devices	
		-A	-AZ
Lead (Pb)	< 1000 PPM	Not Detected	(*)
Mercury	< 1000 PPM	Not Detected	
Cadmium	< 100 PPM	Not Detected	
Hexavalent Chromium	< 1000 PPM	Not Detected	
PBB	< 1000 PPM	Not Detected	
PBDE	< 1000 PPM	Not Detected	

If you should have any additional questions regarding our devices and compliance to environmental standards, please do not hesitate to contact your local representative.

**Important Information and Disclaimer:** Information provided by CEL on its website or in other communications concerning the substance content of its products represents knowledge and belief as of the date that it is provided. CEL bases its knowledge and belief on information provided by third parties and makes no representation or warranty as to the accuracy of such information. Efforts are underway to better integrate information from third parties. CEL has taken and continues to take reasonable steps to provide representative and accurate information but may not have conducted destructive testing or chemical analysis on incoming materials and chemicals. CEL and CEL suppliers consider certain information to be proprietary, and thus CAS numbers and other limited information may not be available for release.

In no event shall CEL’s liability arising out of such information exceed the total purchase price of the CEL part(s) at issue sold by CEL to customer on an annual basis.

See CEL Terms and Conditions for additional clarification of warranties and liability.