

Part number notation

The part number noted on the following pages is a conventional part number.

The new Matsushita global number is:

PNZ312DN

PN312D(N)

Silicon PIN Dual Photodiode

For optical information systems

■ Features

- Fast response : $t_r, t_f = 10 \text{ ns (typ.)}$
- Good photo current linearity
- Low dark current : $I_D = 20 \text{ nA (max.)}$
- Small size plastic package (flat type)
- Adoption of visible light cutoff resin

■ Applications

- Auto focus sensor for still cameras and video cameras etc.
- Distance measuring systems
- Position sensor for automatic assembly lines
- Eye sensor for industrial robots

■ Absolute Maximum Ratings ($T_a = 25^\circ\text{C}$)

Parameter	Symbol	Rated	Unit
Reverse voltage (DC)	V_R	30	V
Power dissipation	P_D	30	mW
Operating ambient temperature	T_{opr}	-25 to +85	$^\circ\text{C}$
Storage temperature	T_{stg}	-30 to +100	$^\circ\text{C}$

■ Electro-Optical Characteristics ($T_a = 25^\circ\text{C}$)

Parameter	Symbol	Conditions	min	typ	max	Unit
Reverse voltage (DC)	V_R	$I_R = 10\mu\text{A}$	30			V
Dark current	I_D	$V_R = 10\text{V}$			20	nA
Photo current	I_L^{*3}	$V_R = 10\text{V}, L = 1000 \text{ lx}^{*1}$	8	12		μA
Peak sensitivity wavelength	λ_p	$V_R = 10\text{V}$		940		nm
Response time	t_r, t_f^{*2}	$V_R = 10\text{V}, R_L = 1\text{k}\Omega$		10		ns
Capacitance between pins	C_t	$V_R = 10\text{V}, f = 1\text{MHz}$		5		pF
Acceptance half angle	θ	Measured from the optical axis to the half power point		65		deg.

Note) The indicated values for absolute maximum ratings and electro-optical characteristics are the values corresponding to individual elements.

*1 Measurements were made using a white tungsten lamp (color temperature $T = 2856\text{K}$) as a light source.

*2 Semiconductor laser light source ($\lambda = 800 \text{ nm}$)

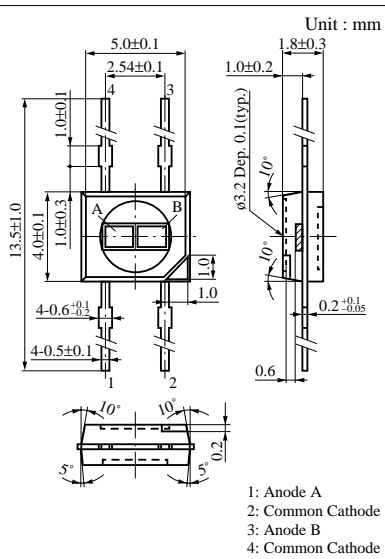

Note) The PN312D(N) package consists of a visible light cutoff resin. Therefore the chips (A and B) shown in the drawing cannot actually be seen.

■ Dimensions of detection area

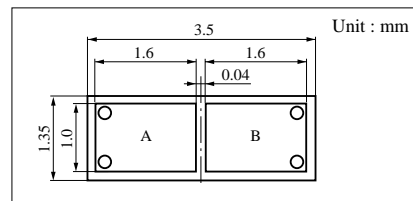

*3 Photo current measurement circuit

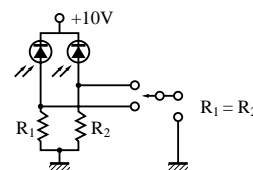

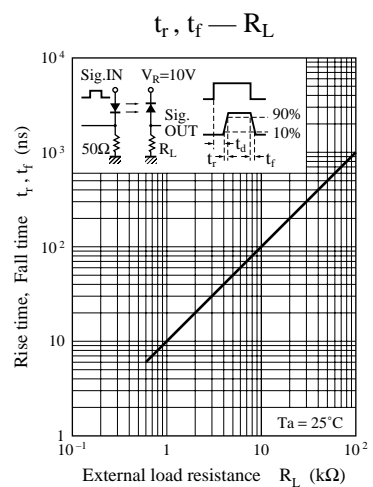
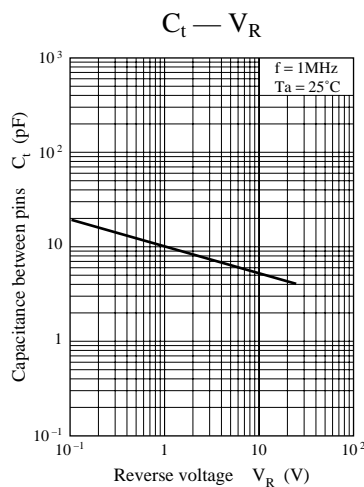
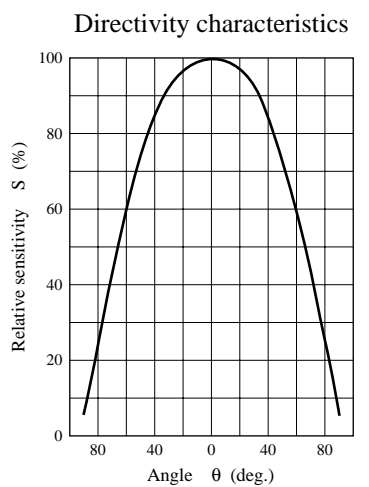
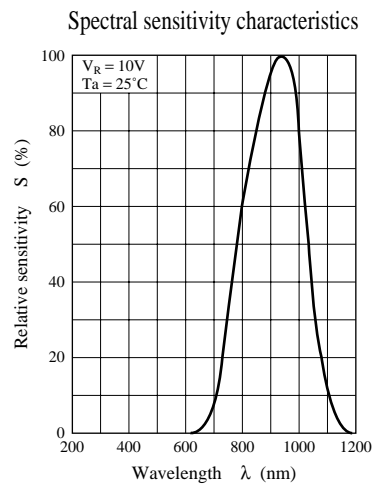
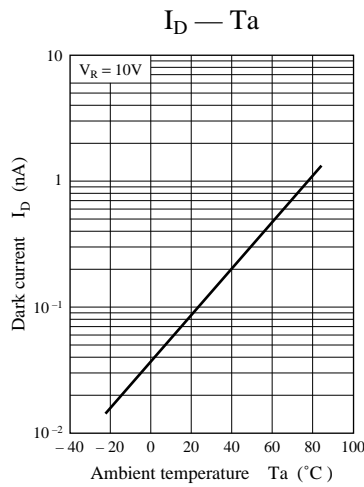
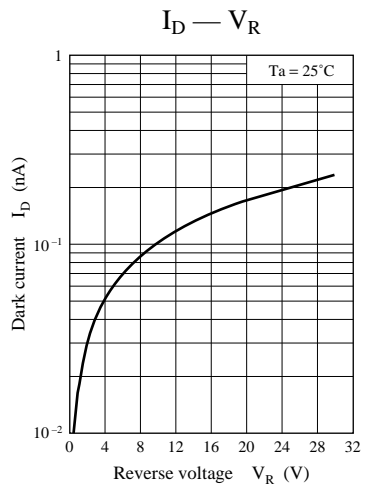
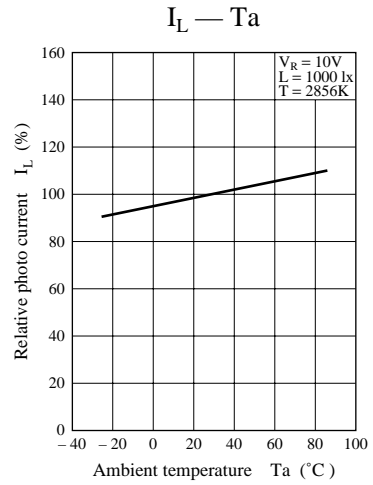
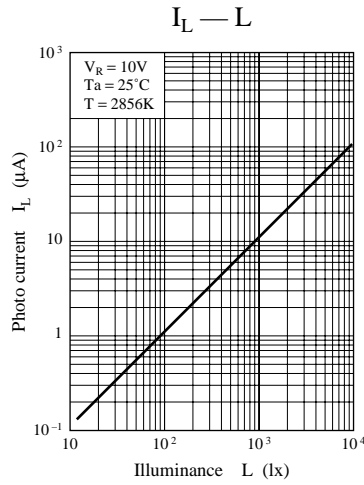
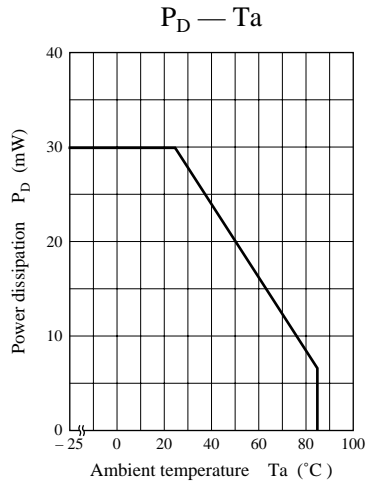

Request for your special attention and precautions in using the technical information and semiconductors described in this material

- (1) An export permit needs to be obtained from the competent authorities of the Japanese Government if any of the products or technologies described in this material and controlled under the "Foreign Exchange and Foreign Trade Law" is to be exported or taken out of Japan.
- (2) The technical information described in this material is limited to showing representative characteristics and applied circuit examples of the products. It does not constitute the warranting of industrial property, the granting of relative rights, or the granting of any license.
- (3) The products described in this material are intended to be used for standard applications or general electronic equipment (such as office equipment, communications equipment, measuring instruments and household appliances).
Consult our sales staff in advance for information on the following applications:
 - Special applications (such as for airplanes, aerospace, automobiles, traffic control equipment, combustion equipment, life support systems and safety devices) in which exceptional quality and reliability are required, or if the failure or malfunction of the products may directly jeopardize life or harm the human body.
 - Any applications other than the standard applications intended.
- (4) The products and product specifications described in this material are subject to change without notice for reasons of modification and/or improvement. At the final stage of your design, purchasing, or use of the products, therefore, ask for the most up-to-date Product Standards in advance to make sure that the latest specifications satisfy your requirements.
- (5) When designing your equipment, comply with the guaranteed values, in particular those of maximum rating, the range of operating power supply voltage and heat radiation characteristics. Otherwise, we will not be liable for any defect which may arise later in your equipment.
Even when the products are used within the guaranteed values, redundant design is recommended, so that such equipment may not violate relevant laws or regulations because of the function of our products.
- (6) When using products for which dry packing is required, observe the conditions (including shelf life and after-unpacking standby time) agreed upon when specification sheets are individually exchanged.
- (7) No part of this material may be reprinted or reproduced by any means without written permission from our company.

Please read the following notes before using the datasheets

- A. These materials are intended as a reference to assist customers with the selection of Panasonic semiconductor products best suited to their applications.
Due to modification or other reasons, any information contained in this material, such as available product types, technical data, and so on, is subject to change without notice.
Customers are advised to contact our semiconductor sales office and obtain the latest information before starting precise technical research and/or purchasing activities.
- B. Panasonic is endeavoring to continually improve the quality and reliability of these materials but there is always the possibility that further rectifications will be required in the future. Therefore, Panasonic will not assume any liability for any damages arising from any errors etc. that may appear in this material.
- C. These materials are solely intended for a customer's individual use.
Therefore, without the prior written approval of Panasonic, any other use such as reproducing, selling, or distributing this material to a third party, via the Internet or in any other way, is prohibited.