

SUPER BRIGHT T-1 3/4 (5 mm) LED LAMP - Water Clear

PACKAGE DIMENSIONS

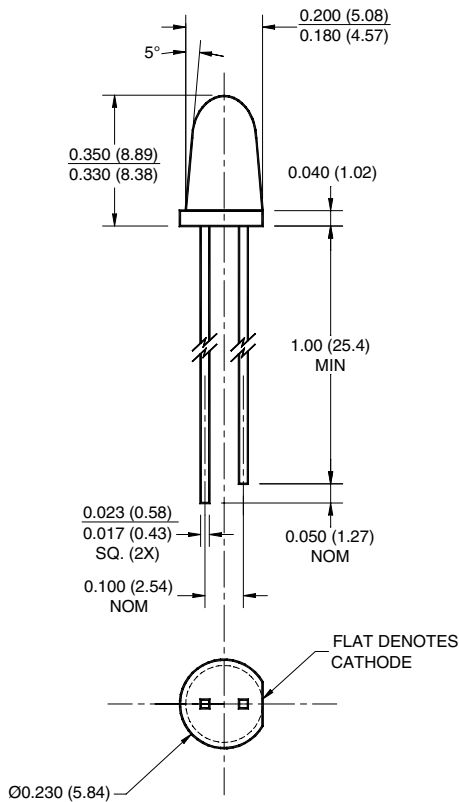

NOTES:

1. Dimensions for all drawings are in inches (mm).
2. Lead spacing is measured where the leads emerge from the package.
3. Protruded resin under the flange is 1.5 mm (0.059") max.

SUPER RED

MV811X

MV8111 MV8112

MV8113 MV8114

FEATURES

- Popular T-1 3/4 package
- Super high brightness suitable for outdoor applications
- Solid state reliability
- Water clear optics
- Standard 100 mil. lead spacing

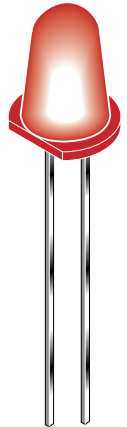

DESCRIPTION

This T-1 3/4 super bright LED has a narrow viewing angle of 12° for concentrated light output. The MV811X series is made with an AlGaAs LED that emits red light at 660 nm. It is encapsulated in a water clear epoxy lens package.

ABSOLUTE MAXIMUM RATINGS (T_A = 25°C unless otherwise specified)

Parameter	Symbol	Rating	Unit
Operating Temperature	T _{OPR}	-40 to +100	°C
Storage Temperature	T _{STG}	-40 to +100	°C
Lead Soldering Time	T _{SOL}	260 for 5 sec	°C
Continuous Forward Current	I _F	30	mA
Peak Forward Current (f = 1.0 KHz, Duty Factor = 1/10)	I _F	200	mA
Reverse Voltage	V _R	5	V
Power Dissipation	P _D	100	mW

SUPER BRIGHT T-1 3/4 (5 mm) LED LAMP - Water Clear

SUPER RED **MV811X**
MV8111 MV8112
MV8113 MV8114

ELECTRICAL / OPTICAL CHARACTERISTICS (T _A =25°C)					
Part Number	MV8111	MV8112	MV8113	MV8114	Condition
Luminous Intensity (mcd)					I _F = 20mA
Minimum	250	630	1000	1600	
Typical	370	940	1500	2400	
Forward Voltage (V)					I _F = 20mA
Maximum	2.4	2.4	2.4	2.4	
Typical	1.7	1.7	1.7	1.7	
Peak Wavelength (nm)	660	660	660	660	I _F = 20mA
Spectral Line Half Width (nm)	20	20	20	20	I _F = 20mA
Viewing Angle (°)	12	12	12	12	I _F = 20mA

TYPICAL PERFORMANCE CURVES

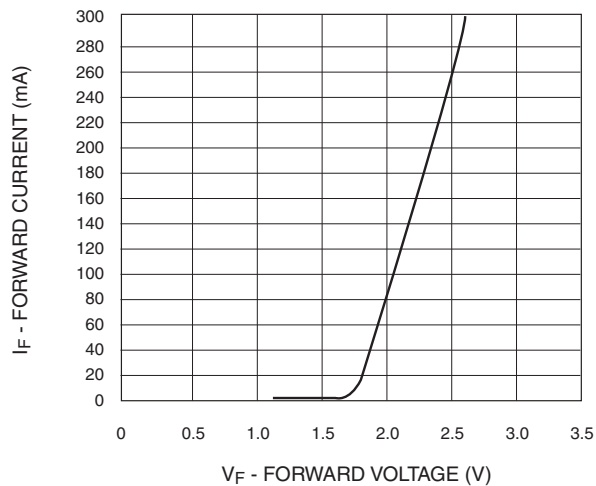

Fig. 1 Forward Current vs. Forward Voltage

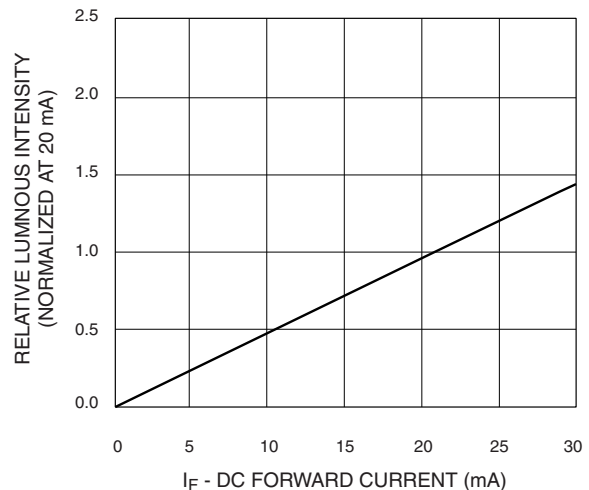

Fig. 2 Relative Luminous Intensity vs. DC Forward Current

SUPER BRIGHT T-1 3/4 (5 mm) LED LAMP - Water Clear

SUPER RED	MV811X
MV8111 MV8112	
MV8113 MV8114	

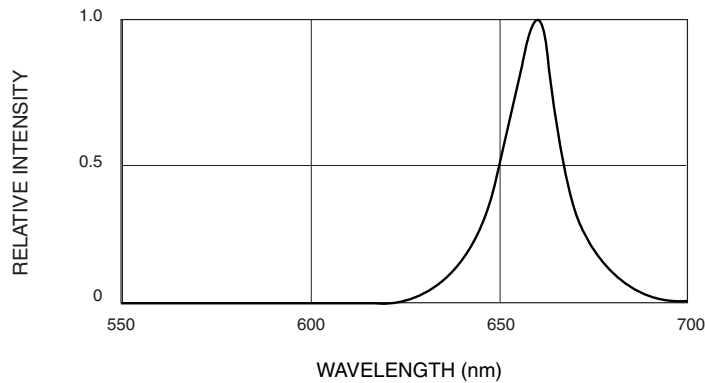

Fig. 3 Relative Intensity vs. Peak Wavelength

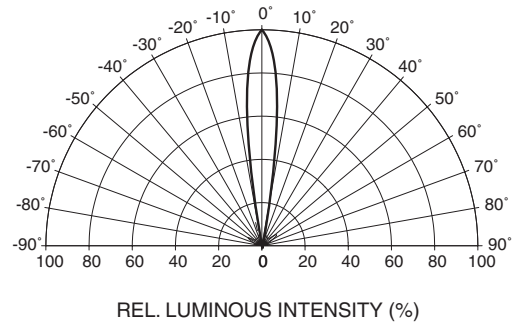

Fig. 4 Radiation Diagram

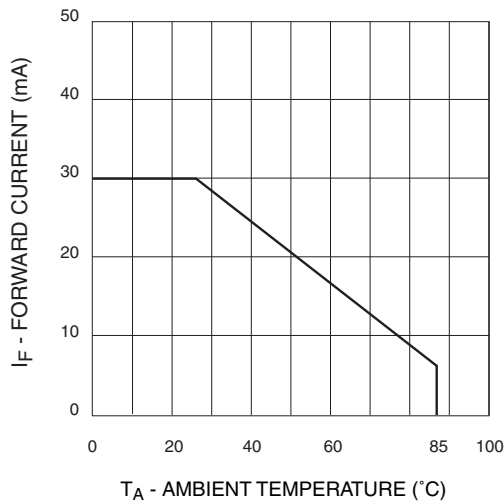

Fig. 5 Current Derating Curve