

FPN660/FPN660A

PNP Low Saturation Transistor

- These devices are designed for high current gain and low saturation voltage with collector currents up to 3.0A continuous.
- Sourced from process PA.

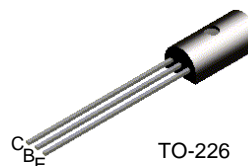

Absolute Maximum Ratings $T_A=25^\circ\text{C}$ unless otherwise noted

Symbol	Parameter	FPN660	FPN660A	Units
V_{CEO}	Collector-Emitter Voltage	60	60	V
V_{CBO}	Collector-Base Voltage	80	60	V
V_{EBO}	Emitter-Base Voltage	5	5	V
I_C	Collector Current - Continuous	3	3	A
T_J, T_{STG}	Operating and Storage Junction Temperature Range	-55 ~ +150	-55 ~ +150	$^\circ\text{C}$

* These ratings are limiting values above which the serviceability of any semiconductor device may be impaired.

NOTES:

- 1) These ratings are based on a maximum junction temperature of 150°C .
- 2) These are steady state limits. The factory should be consulted on applications involving pulsed or low duty cycle operations.
- 3) All voltage (V) and currents (A) are negative polarity for PNP transistors

Electrical Characteristics $T_A=25^\circ\text{C}$ unless otherwise noted

Symbol	Parameter	Test Conditions	Min.	Typ.	Max.	Units
Off Characteristics						
BV_{CEO}	Collector-Emitter Breakdown Voltage	$I_C = 10\text{mA}, I_B = 0$	55			V
BV_{CBO}	Collector-Base Breakdown Voltage	$I_E = 100\mu\text{A}, I_C = 0$	80			V
		FPN660	60			V
		FPN660A				
BV_{EBO}	Emitter-Base Breakdown Voltage	$I_E = 100\mu\text{A}, I_C = 0$	5.0			V
I_{CBO}	Collector-Base Cutoff Current	$V_{CB} = 30\text{V}, I_E = 0$			100	nA
		$V_{CB} = 30\text{V}, I_E = 0, T_A = 100^\circ\text{C}$			10	μA
I_{EBO}	Emitter-Base Cutoff Current	$V_{EB} = 4.0\text{V}, I_C = 0$			100	nA
On Characteristics *						
h_{FE}	DC Current Gain	$I_C = 100\text{mA}, V_{CE} = 2.0\text{V}$	70			
		$I_C = 500\text{mA}, V_{CE} = 2.0\text{V}$	100		300	
		FPN660	250		550	
		FPN660A	80			
		$I_C = 1.0\text{A}, V_{CE} = 2.0\text{V}$	40			
		$I_C = 2.0\text{A}, V_{CE} = 2.0\text{V}$				
$V_{CE(sat)}$	Collector-Emitter Saturation Voltage	$I_C = 1.0\text{A}, I_B = 100\text{mA}$			300	mV
		$I_C = 2.0\text{A}, I_B = 200\text{mA}$			450	mV
		FPN660			400	mV
		FPN660A				
$V_{BE(sat)}$	Base-Emitter Saturation Voltage	$I_C = 1.0\text{A}, I_B = 100\text{mA}$			1.25	V
$V_{BE(on)}$	Base-Emitter On Voltage	$I_C = 1.0\text{A}, V_{CE} = 2.0\text{V}$			1.0	V
Small Signal Characteristics						
C_{obo}	Output Capacitance	$V_{CB} = 10\text{V}, I_E = 0, f = 1\text{MHz}$			45	pF
f_T	Transition Frequency	$I_C = 100\text{mA}, V_{CE} = 5.0\text{V}, f = 100\text{MHz}$	75			MHz

* Pulse Test: Pulse Width $\leq 300\mu\text{s}$, Duty Cycle $\leq 2.0\%$

NOTE: All voltage (V) and currents (A) are negative polarity for PNP transistors.

Thermal Characteristics $T_A=25^{\circ}\text{C}$ unless otherwise noted

Symbol	Parameter	Max.	Units
		FPN660/FPN660A	
P_D	Total Device Dissipation	1	W
$R_{\theta JC}$	Thermal Resistance, Junction to Case	50	$^{\circ}\text{C}/\text{W}$
$R_{\theta JA}$	Thermal Resistance, Junction to Ambient	125	$^{\circ}\text{C}/\text{W}$

Typical Characteristics

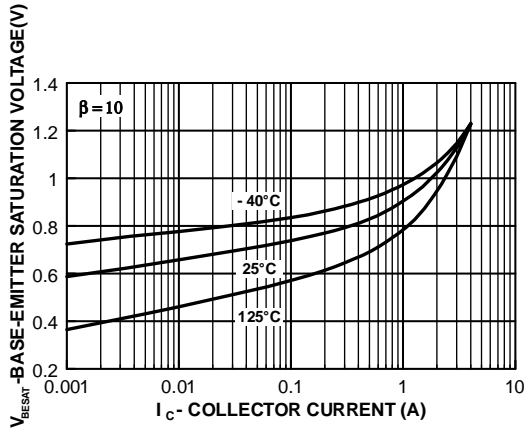

Figure 1. Base-Emitter Saturation Voltage vs Collector Current
Collector-Emitter Saturation

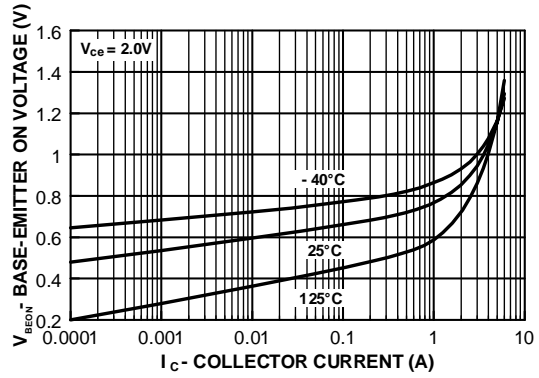

Figure 2. Base-Emitter On Voltage vs Collector Current

Input/Output Capacitance vs

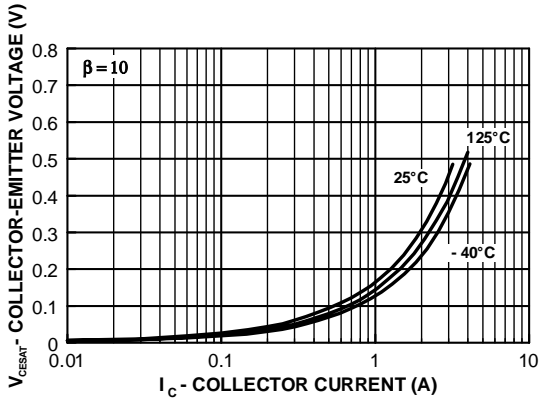

Figure 3. Collector-Emitter Saturation Voltage vs Collector Current

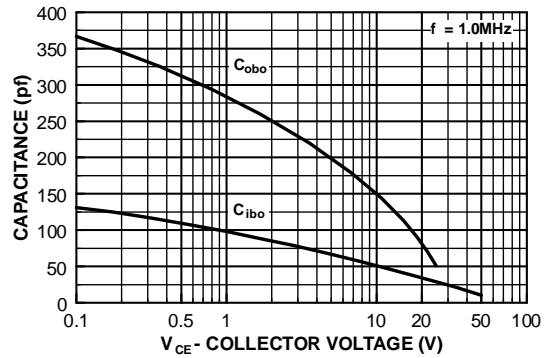

Figure 4. Input/Output Capacitance vs Reverse Bias Voltage

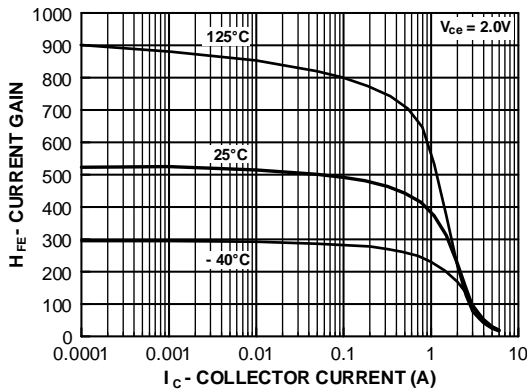

Figure 5. Current Gain vs Collector Current

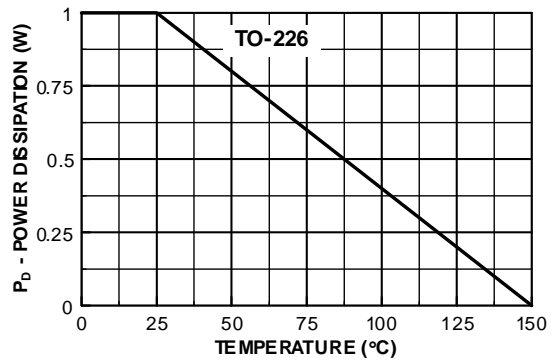
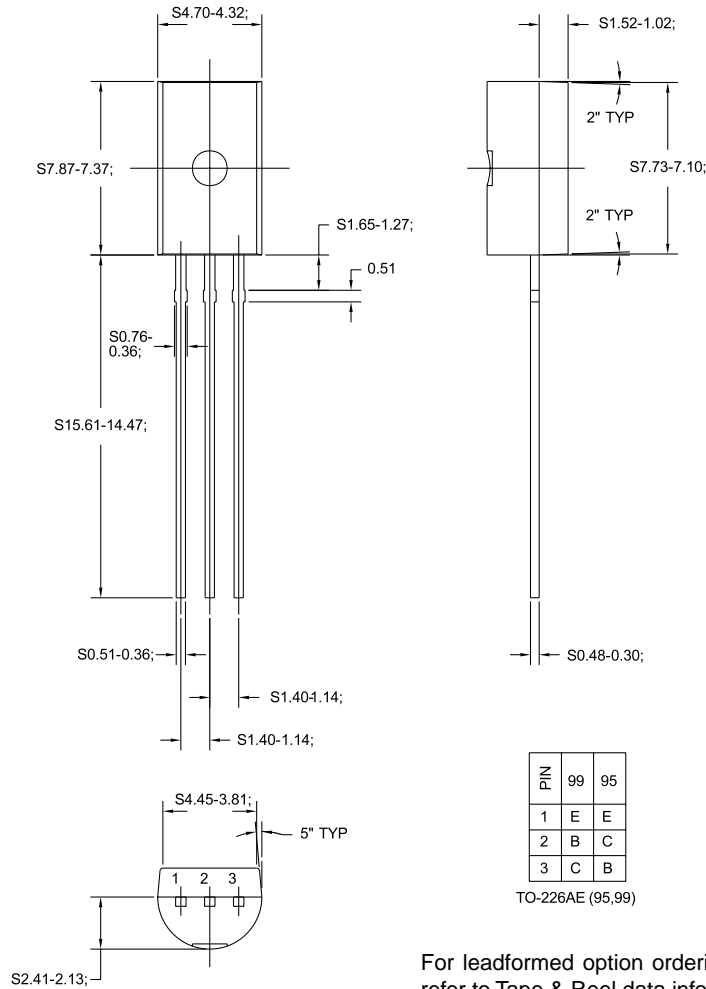

Figure 6. Power Dissipation vs Ambient Temperature

Package Dimensions

TO-226

FPN660/FPN660A



Dimensions in Millimeters

TRADEMARKS

The following are registered and unregistered trademarks Fairchild Semiconductor owns or is authorized to use and is not intended to be an exhaustive list of all such trademarks.

ACE [™]	FACT [™]	ImpliedDisconnect [™]	PACMAN [™]	SPM [™]
ActiveArray [™]	FACT Quiet series [™]	ISOPLANAR [™]	POP [™]	Stealth [™]
Bottomless [™]	FAST [®]	LittleFET [™]	Power247 [™]	SuperSOT [™] -3
CoolFET [™]	FAST ^r [™]	MicroFET [™]	PowerTrench [®]	SuperSOT [™] -6
CROSSVOL ^T [™]	FRFET [™]	MicroPak [™]	QFET [™]	SuperSOT [™] -8
DOME [™]	GlobalOptoisolator [™]	MICROWIRE [™]	QS [™]	SyncFET [™]
EcoSPARK [™]	GTO [™]	MSX [™]	QT Optoelectronics [™]	TinyLogic [™]
E ² CMOS [™]	HiSeC [™]	MSXPro [™]	Quiet Series [™]	TruTranslation [™]
EnSigna [™]	I ² C [™]	OCX [™]	RapidConfigure [™]	UHC [™]
Across the board. Around the world. [™]		OCXPro [™]	RapidConnect [™]	UltraFET [®]
The Power Franchise [™]		OPTOLOGIC [®]	SILENT SWITCHER [®]	VCX [™]
Programmable Active Droop [™]		OPTOPLANAR [™]	SMART START [™]	

DISCLAIMER

FAIRCHILD SEMICONDUCTOR RESERVES THE RIGHT TO MAKE CHANGES WITHOUT FURTHER NOTICE TO ANY PRODUCTS HEREIN TO IMPROVE RELIABILITY, FUNCTION OR DESIGN. FAIRCHILD DOES NOT ASSUME ANY LIABILITY ARISING OUT OF THE APPLICATION OR USE OF ANY PRODUCT OR CIRCUIT DESCRIBED HEREIN; NEITHER DOES IT CONVEY ANY LICENSE UNDER ITS PATENT RIGHTS, NOR THE RIGHTS OF OTHERS.

LIFE SUPPORT POLICY

FAIRCHILD'S PRODUCTS ARE NOT AUTHORIZED FOR USE AS CRITICAL COMPONENTS IN LIFE SUPPORT DEVICES OR SYSTEMS WITHOUT THE EXPRESS WRITTEN APPROVAL OF FAIRCHILD SEMICONDUCTOR CORPORATION.

As used herein:

1. Life support devices or systems are devices or systems which, (a) are intended for surgical implant into the body, or (b) support or sustain life, or (c) whose failure to perform when properly used in accordance with instructions for use provided in the labeling, can be reasonably expected to result in significant injury to the user.
2. A critical component is any component of a life support device or system whose failure to perform can be reasonably expected to cause the failure of the life support device or system, or to affect its safety or effectiveness.

PRODUCT STATUS DEFINITIONS

Definition of Terms

Datasheet Identification	Product Status	Definition
Advance Information	Formative or In Design	This datasheet contains the design specifications for product development. Specifications may change in any manner without notice.
Preliminary	First Production	This datasheet contains preliminary data, and supplementary data will be published at a later date. Fairchild Semiconductor reserves the right to make changes at any time without notice in order to improve design.
No Identification Needed	Full Production	This datasheet contains final specifications. Fairchild Semiconductor reserves the right to make changes at any time without notice in order to improve design.
Obsolete	Not In Production	This datasheet contains specifications on a product that has been discontinued by Fairchild semiconductor. The datasheet is printed for reference information only.