

March 1996

Features

- Devices QML Qualified in Accordance with MIL-PRF-38535
- Detailed Electrical and Screening Requirements are Contained in SMD# 5962-95818 and Intersil' QM Plan
 - Radiation Hardened CMOS Process
 - Total Dose 1×10^5 RAD (Si)
 - Transient Upset $> 1 \times 10^8$ RAD (Si)/s
 - Latch-Up Immune EPI-CMOS $> 1 \times 10^{12}$ RAD (Si)/s
- Low Power Dissipation
- High Noise Immunity
- Single Power Supply +5V
- Low Input Load Current
- 8-Bit Data Register and Buffer
- Asynchronous Register Clear
- Service Request Flip-Flop for Interrupt Generation
- Three-State Outputs
- Bus-Compatible with HS-80C85RH CPU
- Electrically Equivalent to Sandia SA3026
- Military Temperature Range -55°C to $+125^{\circ}\text{C}$

Description

The Intersil HS-82C12RH is a radiation hardened 8-bit input/output port designed for use with the HS-80C85RH radiation hardened microprocessor. It is manufactured using a self-aligned, junction-isolated EPI-CMOS process and features three-state output buffers and device selection and control logic. A service request flip-flop is included for the generation and control of interrupts to the microprocessor. The device can be used in implement many of the peripheral and input/output functions of a microcomputer system. The HS-82C12RH is pinout- and function- compatible with industry-standard 8212 devices.

Functional Diagram

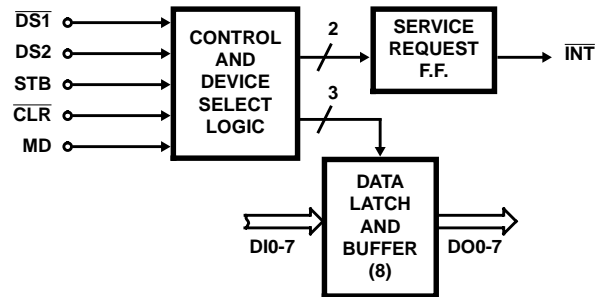

Pin Description

PIN	DESCRIPTION
DI0-DI7	Data In
DO0-DO7	Data Out
DS1, DS2	Device Select
MD	Mode
STB	Strobe
INT	Interrupt
CLR	Clear

Ordering Information

PART NUMBER	TEMPERATURE RANGE	SCREENING LEVEL	PACKAGE
5962R9581801QJC	-55°C to $+125^{\circ}\text{C}$	MIL-PRF-38535 Level Q	24 Lead SBDIP
5962R9581801QXC	-55°C to $+125^{\circ}\text{C}$	MIL-PRF-38535 Level Q	24 Lead Ceramic Flatpack
5962R9581801VJC	-55°C to $+125^{\circ}\text{C}$	MIL-PRF-38535 Level V	24 Lead SBDIP
5962R9581801VXC	-55°C to $+125^{\circ}\text{C}$	MIL-PRF-38535 Level V	24 Lead Ceramic Flatpack
HS1-82C12RH/Sample	$+25^{\circ}\text{C}$	Sample	24 Lead SBDIP
HS9-82C12RH/Sample	$+25^{\circ}\text{C}$	Sample	24 Lead Ceramic Flatpack

HS-82C12RH

Pinouts

24 LEAD CERAMIC DUAL-IN-LINE
METAL SEAL PACKAGE (SBDIP)
MIL-STD-1835 CDIP2-T24
TOP VIEW

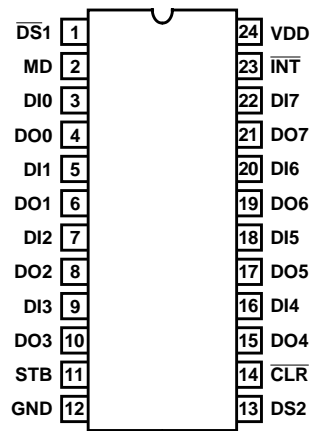

24 LEAD CERAMIC METAL SEAL
FLATPACK PACKAGE (FLATPACK)
MIL-STD-1835 CDFP4-F24
TOP VIEW

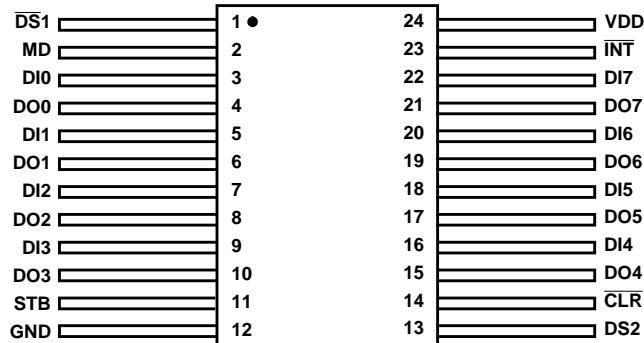

Specifications HS-82C12RH

Absolute Maximum Ratings

Supply Voltage	+7.0V
Input, Output or I/O Voltage	GND-0.3V to VDD+0.3V
Storage Temperature Range	-65°C to +150°C
Junction Temperature	+175°C
Lead Temperature (Soldering 10s)	+300°C
ESD Classification	Class 1

Reliability Information

Thermal Resistance	θ_{JA}	θ_{JC}
SBDIP Package	55°C/W	14°C/W
Ceramic Flatpack Package	74°C/W	13°C/W
Maximum Package Power Dissipation at +125°C Ambient		
SBDIP Package	0.91W	
Ceramic Flatpack Package	0.68W	
If device power exceeds package dissipation capability, provide heat sinking or derate linearly at the following rate:		
SBDIP Package	18.2mW/C	
Ceramic Flatpack Package	13.5mW/C	

CAUTION: Stresses above those listed in "Absolute Maximum Ratings" may cause permanent damage to the device. This is a stress only rating and operation of the device at these or any other conditions above those indicated in the operational sections of this specification is not implied.

Operating Conditions

Operating Voltage Range	+4.75V to +5.25V	Input Low Voltage	0V to +1.0V
Operating Temperature Range	-55°C to +125°C	Input High Voltage	VDD -1V to VDD

TABLE 1. DC ELECTRICAL PERFORMANCE CHARACTERISTICS

PARAMETER	SYMBOL	CONDITIONS	GROUP A SUBGROUPS	TEMPERATURE	LIMITS		UNITS
					MIN	MAX	
High Input Leakage Current	I _{IH}	VDD = 5.25V, V _{IN} = 0V, Pin under test = 5.25V	1, 2, 3	-55°C, +25°C, +125°C	-	1	μA
Low Input Leakage Current	I _{IL}	VDD = 5.25V, V _{IN} = 5.25V, Pin under test = 0V	1, 2, 3	-55°C, +25°C, +125°C	-1	-	μA
Low Output Voltage	V _{OL}	VDD = 5.25V, I _{OL} = 2mA	1, 2, 3	-55°C, +25°C, +125°C	-	0.5	V
High Output Voltage	V _{OH}	VDD = 4.75V, I _{OH} = -2mA	1, 2, 3	-55°C, +25°C, +125°C	4.25	-	V
Static Current	S _{IDD}	VDD = 5.25V, V _{IN} = GND	1, 2, 3	-55°C, +25°C, +125°C	-	100	μA
Functional Tests	FT	VDD = 4.75V and 5.25V, V _{IH} = VDD-1.0V, V _{IL} = 1.0V	7, 8A, 8B	-55°C, +25°C, +125°C	-	-	-

NOTE: All devices are guaranteed at worst case limits and over radiation.

TABLE 2. AC ELECTRICAL PERFORMANCE CHARACTERISTICS

PARAMETER	SYMBOL	GROUP A SUB-GROUPS	TEMPERATURE	LIMITS		UNITS
				MIN	MAX	
Data to Output Delay	TPD	9, 10, 11	-55°C, +25°C, +125°C	-	105	ns
Write Enable to Output Delay	TWE	9, 10, 11	-55°C, +25°C, +125°C	-	200	ns
Reset to Output Delay	TR	9, 10, 11	-55°C, +25°C, +125°C	-	145	ns
Set to Output Delay	TS	9, 10, 11	-55°C, +25°C, +125°C	-	100	ns
Clear to Output Delay	TC	9, 10, 11	-55°C, +25°C, +125°C	-	135	ns
Output Enable Time	TE	9, 10, 11	-55°C, +25°C, +125°C	-	125	ns
Output Disable Time	TD	9, 10, 11	-55°C, +25°C, +125°C	-	85	ns

NOTE:

- Output Timings are measured with the following conditions: CL = 100pF, V_{IH} = 3.75V, and V_{IL} = 1.0V

Specifications HS-82C12RH

TABLE 3. ELECTRICAL PERFORMANCE CHARACTERISTICS

PARAMETER	SYMBOL	CONDITIONS	GROUP A SUBGROUPS	TEMPERATURE	LIMITS		UNITS
					MIN	MAX	
Input Capacitance	CIN	VDD = Open, f = 1MHz, All measurements referenced to device ground		T _A = +25°C	-	8	pF
Output Capacitance	COUT	VDD = Open, f = 1MHz, All measurements referenced to device ground		T _A = +25°C	-	8	pF
Pulse Width	TPW	VDD = 4.75, VIH = 3.75, VIL = 1.0	9, 10, 11	-55°C, +25°C, +125°C	-	50	ns
Data Set Up Time	TSET	VDD = 4.75, VIH = 3.75, VIL = 1.0	9, 10, 11	-55°C, +25°C, +125°C	-	30	ns
Data Hold Time	TH	VDD = 4.75, VIH = 3.75, VIL = 1.0	9, 10, 11	-55°C, +25°C, +125°C	-	40	ns

NOTE: The parameters listed in Table 3 are controlled via design or process parameters and are not directly tested. These parameters are characterized upon initial design release and upon design changes which would affect these characteristics.

TABLE 4. POST 100K RAD ELECTRICAL PERFORMANCE CHARACTERISTICS

NOTE: The Post Irradiation test conditions and limits are the same as those listed in Table 1 and Table 2.

Timing Waveforms

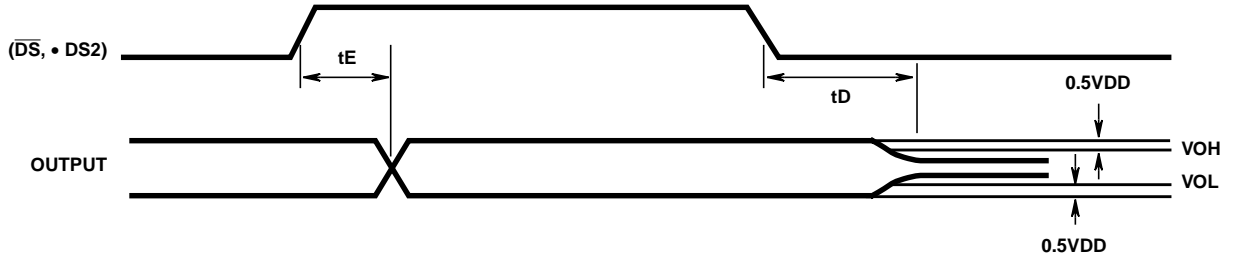

FIGURE 1. READ TIMING

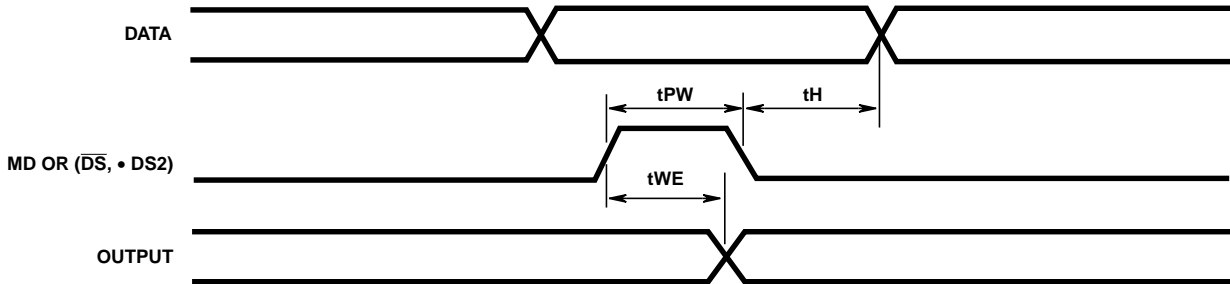

FIGURE 2. WRITE TIMING

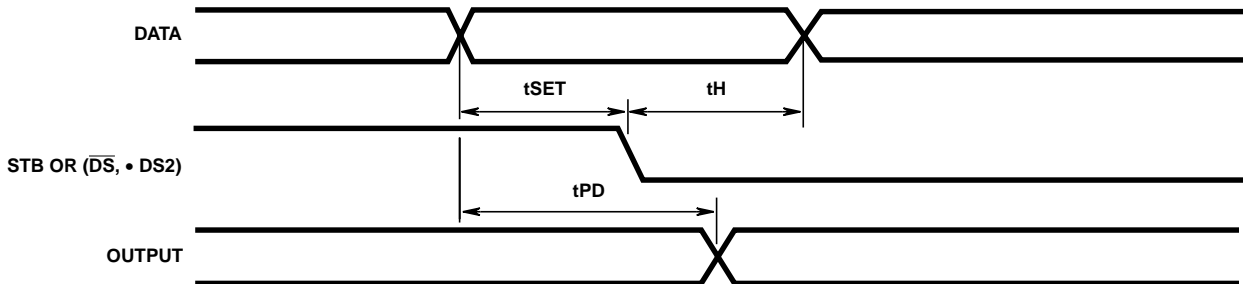

FIGURE 3. DATA SETUP, HOLD, PROPAGATION DELAY TIMING

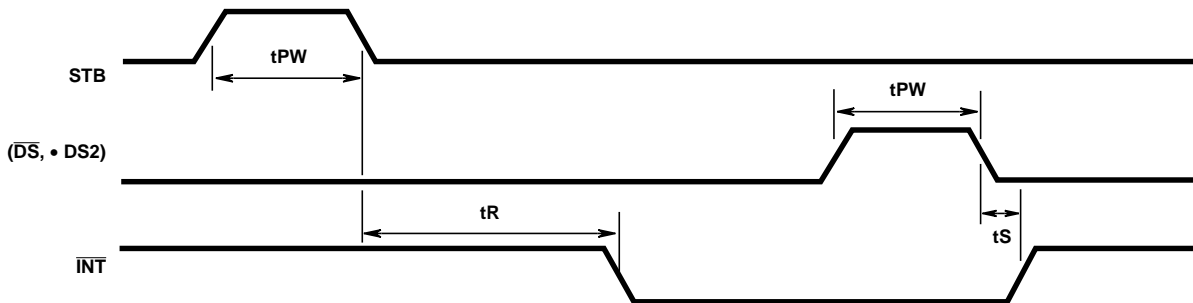

FIGURE 4. INTERRUPT TIMING

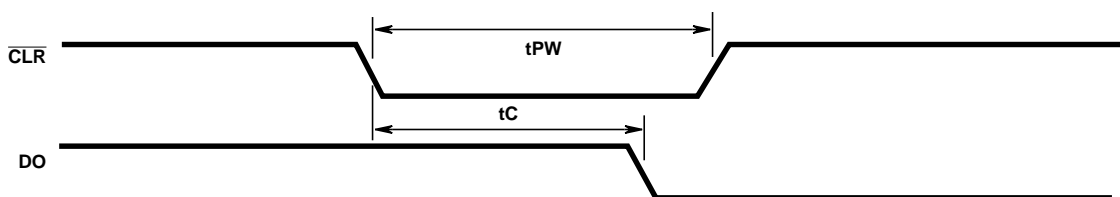

FIGURE 5. CLEAR TIMING

Functional Description

Data Latch

The data latch is comprised of eight "D" type flip-flops. The output of each flip-flop will follow the corresponding data input (DI0 - DI7) when the clock (C) is high. The clock input is level sensitive and the data becomes latched when the clock returns low.

An asynchronous reset ($\overline{\text{CLR}}$) is used to clear the latched data. Since the clock (C) overrides the reset ($\overline{\text{CLR}}$), the data must be in the latched state in order to clear the flip-flops. If the data is not latched (i.e. clock is high) when $\overline{\text{CLR}}$ goes low, then the Q outputs of the data latch will continue to follow the data input, overriding the reset signal.

Output Buffer

Three-state buffers are used to provide output drive for the data latch. A high level on the "output buffer enable" control line enables the buffer outputs. When "output buffer enable" is low the buffer outputs are forced to the high-impedance state.

Device Select Logic

The inputs $\overline{\text{DS1}}$ and DS2 are used for device selection. When $\overline{\text{DS1}}$ is low and DS2 is high, the device is selected. The output buffers are enabled and the service request flip-flop is asynchronously cleared when the device is selected.

Mode

the mode input (MD) is used to control the state of the output buffer and to determine the source of the data latch clock (C). When MD is high, the output buffers are enabled and the source of the data latch clock (C) is the device select logic ($\overline{\text{DS1}} \bullet \text{DS2}$).

When MD is low, the state of the output buffer is controlled by the device select logic ($\overline{\text{DS1}} \bullet \text{DS2}$) and the source of the data latch clock is the strobe (STB) input.

Strobe

The strobe input (STB) is used as the data latch clock (C) when the mode input (MD) is low. The service request flip-flop is synchronously set on the negative going edge of STB.

Service Request Flip-Flop

The service request flip-flop is to generate interrupts to microcomputer systems. It is negative edge triggered and asynchronously cleared (reset).

The output of the service request flip-flop is AND-gated with the device select logic ($\overline{\text{DS1}} \bullet \text{DS2}$). The output of the AND gate is the active low interrupt ($\overline{\text{INT}}$) signal.

HS-82C12RH

Logic Diagram

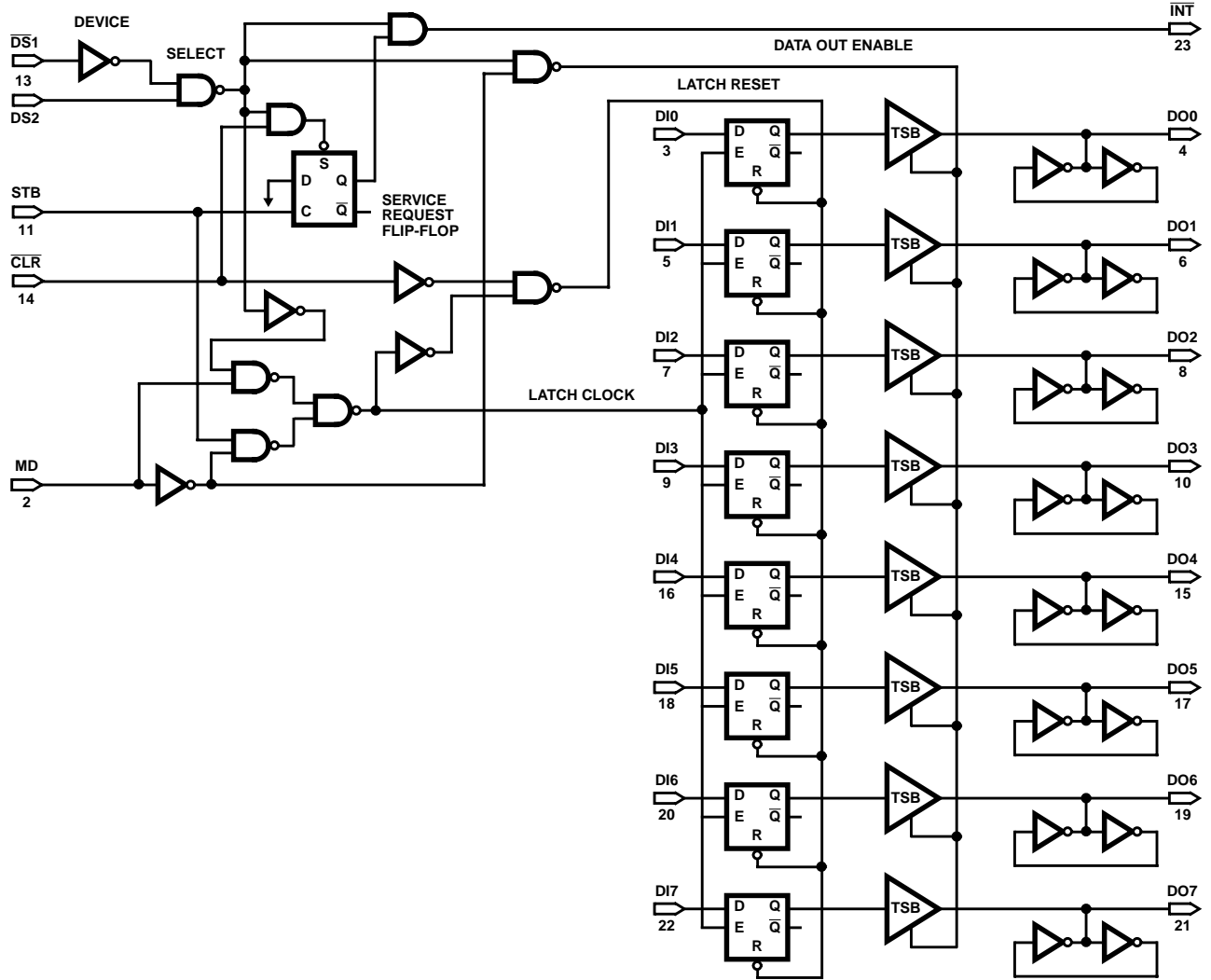

TRUTH TABLE 1. DATA OUT

STB	MD	$\overline{DS1} \cdot DS2$	DATA OUT EQUALS
0	0	0	High Z State
1	0	0	High Z State
0	1	0	Data Latch
1	1	0	Data Latch
0	0	1	Data Latch
1	0	1	Data In
0	1	1	Data In
1	1	1	Data In

TRUTH TABLE 2. \overline{INT}

CLR	$\overline{DS1} \cdot DS2$	STB	Q*	\overline{INT}
0 RESET	0	0	0	1
1	0	0	0	1
1	0	$\overline{\text{pulse}}$	1	0
1	1 RESET	0	0	0
1	0	0	0	1

* Internal Service Request Flip-Flop

HS-82C12RH

Metallization Topology

DIE DIMENSIONS:

90 x 76 x 14 ± 1mils

METALLIZATION:

Type: AlSi

Thickness: 11kÅ ± 2kÅ

GLASSIVATION:

Type: SiO₂

Thickness: 8kÅ ± 1kÅ

Metallization Mask Layout

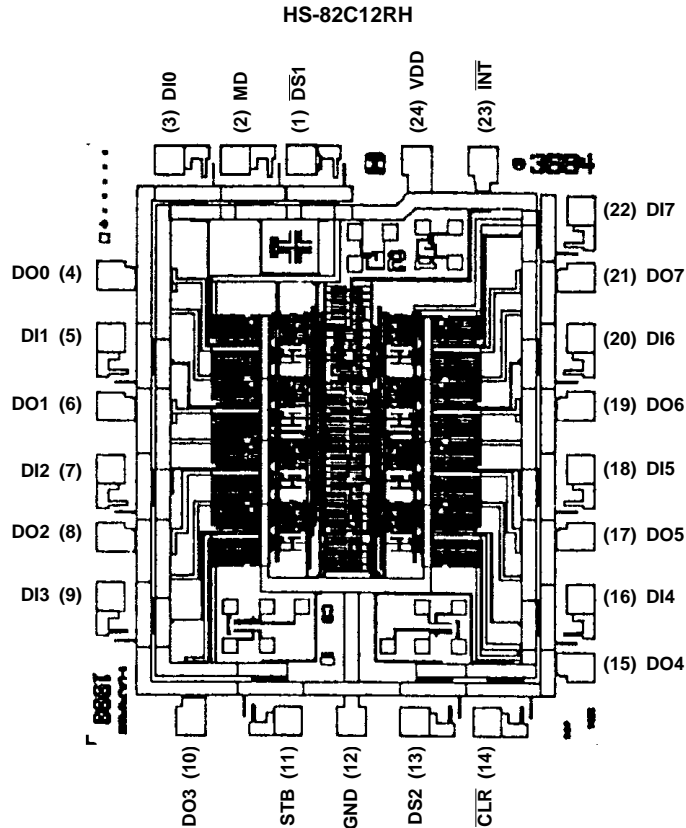

All Intersil semiconductor products are manufactured, assembled and tested under **ISO9000** quality systems certification.

Intersil products are sold by description only. Intersil Corporation reserves the right to make changes in circuit design and/or specifications at any time without notice. Accordingly, the reader is cautioned to verify that data sheets are current before placing orders. Information furnished by Intersil is believed to be accurate and reliable. However, no responsibility is assumed by Intersil or its subsidiaries for its use; nor for any infringements of patents or other rights of third parties which may result from its use. No license is granted by implication or otherwise under any patent or patent rights of Intersil or its subsidiaries.

For information regarding Intersil Corporation and its products, see web site <http://www.intersil.com>