

# 500mA Low Dropout Positive Voltage Regulator

## General Description

The RT9163 is a positive low dropout regulator designed for applications requiring low dropout performance at full rated current. The device is available in fixed output voltage of 3.3V, 3.5V, and 5.0V. The RT9163 provides excellent regulation over line, load, and temperature variations.

The other features include low dropout performance at a maximum of 1.4V at 500mA, fast transient response, internal current limiting, and thermal shutdown protection of the output devices. The RT9163 is a three-terminal regulator available in surface mount SOT-89, SOT-223, and TO-252 packages.

## Applications

- 5V to 3.3V Linear Regulator
- Low Voltage Microcontroller, DSP... etc Power Supply
- Linear Regulator for LAN Card and CD-ROM

## Ordering Information

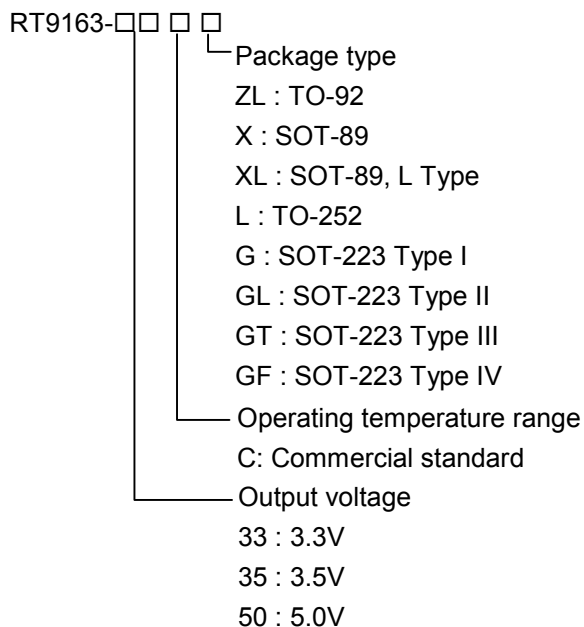

## Features

- **Low Dropout, Maximum 1.4V at 500mA**
- **Fast Transient Response**
- **±2% Total Output Regulation**
- **0.4% Line Regulation**
- **0.4% Load Regulation**
- **TO-92, SOT-89, SOT-223, and TO-252 Packages**

## Pin Configurations

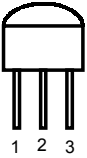
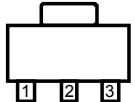
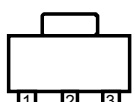
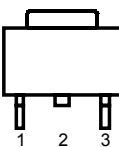
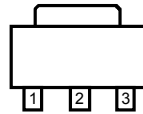
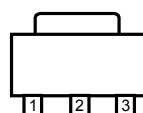
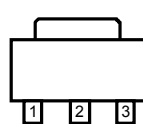
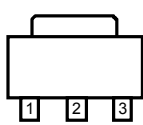
Part Number	Pin Configurations
RT9163-□□CZL (Plastic TO-92)	 <p>TOP VIEW</p> <p>1. VIN 2. GND 3. VOUT</p>
RT9163-□□CX (Plastic SOT-89)	 <p>TOP VIEW</p> <p>1. VOUT 2. GND (TAB) 3. VIN</p>
RT9163-□□CXL (Plastic SOT-89)	 <p>TOP VIEW</p> <p>1. GND 2. VIN (TAB) 3. VOUT</p>
RT9163-□□CL (Plastic TO-252)	 <p>TOP VIEW</p> <p>1. VOUT 2. GND (TAB) 3. VIN</p>
RT9163-□□CG (Plastic SOT-223) Type I	 <p>TOP VIEW</p> <p>1. VOUT 2. GND (TAB) 3. VIN</p>
RT9163-□□CGL (Plastic SOT-223) Type II	 <p>TOP VIEW</p> <p>1. VIN 2. GND (TAB) 3. VOUT</p>
RT9163-□□CGT (Plastic SOT-223) Type III	 <p>TOP VIEW</p> <p>1. GND 2. VOUT (TAB) 3. VIN</p>
RT9163-□□CGF (Plastic SOT-223) Type IV	 <p>TOP VIEW</p> <p>1. GND 2. VIN (TAB) 3. VOUT</p>

## Marking Information

Part Number	Marking
RT9163-33CZL	RTAJ
RT9163-35CZL	RTAK
RT9163-50CZL	RTA1
RT9163-33CX	A8
RT9163-35CX	A9
RT9163-50CX	AT
RT9163-33CXL	CK
RT9163-35CXL	CL
RT9163-50CXL	CM

## Typical Application Circuit

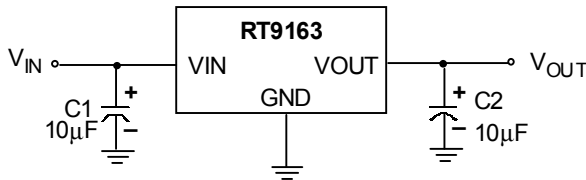

## Pin Description

Pin Name	Pin Function
VOUT	Output Voltage
GND	Ground
VIN	Power Input

## Function Block Diagram

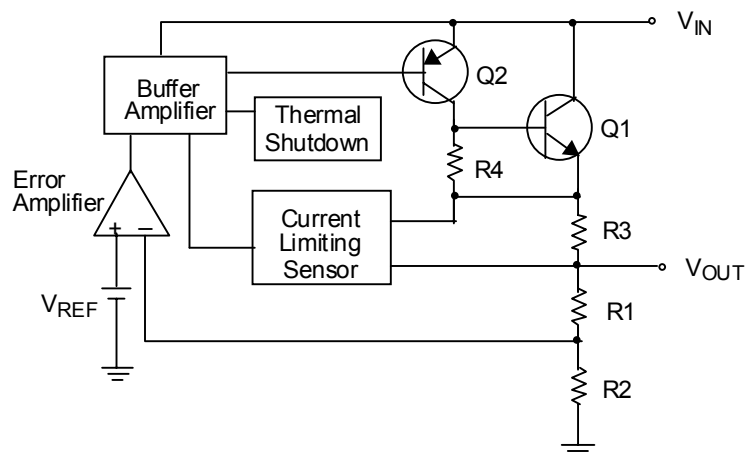

## Absolute Maximum Ratings

- Input Voltage ..... 15V
- Power Dissipation,  $P_D$  @  $T_A = 25^\circ\text{C}$ 
  - TO-92 ..... 0.6W
  - SOT-89 ..... 0.5W
- Package Thermal Resistance
  - TO-92,  $\theta_{JA}$  .....  $160^\circ\text{C/W}$
  - SOT-89,  $\theta_{JC}$  .....  $100^\circ\text{C/W}$
  - SOT-89,  $\theta_{JA}$  .....  $300^\circ\text{C/W}$
  - SOT-223,  $\theta_{JC}$  .....  $15^\circ\text{C/W}$
  - SOT-223,  $\theta_{JA}$  .....  $60^\circ\text{C/W}$
  - TO-252,  $\theta_{JC}$  .....  $15^\circ\text{C/W}$
  - TO-252,  $\theta_{JA}$  .....  $56^\circ\text{C/W}$
- Operating Junction Temperature Range .....  $-40^\circ\text{C}$  to  $125^\circ\text{C}$
- Storage Temperature Range .....  $-65^\circ\text{C}$  to  $150^\circ\text{C}$

## Electrical Characteristics

( $V_{IN} = 5V$ ,  $T_A = 25^\circ\text{C}$ , unless otherwise specified)

Parameter		Symbol	Test Conditions	Min	Typ	Max	Units
Output Voltage <sup>(1)</sup>	RT9163-33	$V_{OUT}$		3.235	3.300	3.365	V
	RT9163-35			3.430	3.500	3.570	
	RT9163-50		$V_{IN} = 7A$	4.900	5.000	5.100	
Line Regulation <sup>(1)</sup>	RT9163-33	$\Delta V_{LINE}$	$V_{IN} = 5V \sim 15V$	--	0.1	0.4	%
	RT9163-35			--	0.1	0.4	
	RT9163-50		$V_{IN} = 7V \sim 15V$	--	0.1	0.4	
Load Regulation <sup>(1)</sup>		$\Delta V_{LOAD}$	$I_L = 0 \sim 500\text{mA}$	--	0.2	0.4	%
Dropout Voltage <sup>(2)</sup>		$V_{DROP}$	$\Delta V_{OUT} = 1\%$	--	1.3	1.4	V
Current Limit		$I_{LIMIT}$	Load = $1\Omega$	550	--	--	mA
Quiescent Current		$I_Q$		--	4.5	8	mA
Temperature Coefficient		$T_C$		--	0.005	--	%/ $^\circ\text{C}$
Temperature Stability		$T_S$		--	0.5	--	%
RMS Output Noise <sup>(3)</sup>				--	0.003	--	%/ $V_{OUT}$

Notes:

- (1) Low duty cycle pulse tested with Kelvin connections.
- (2) Dropout voltage is defined as the input to output differential at which the output voltage drops 100mV below the value measured with a 1V differential.
- (3) Bandwidth of 10 Hz to 10 kHz.

Package Information

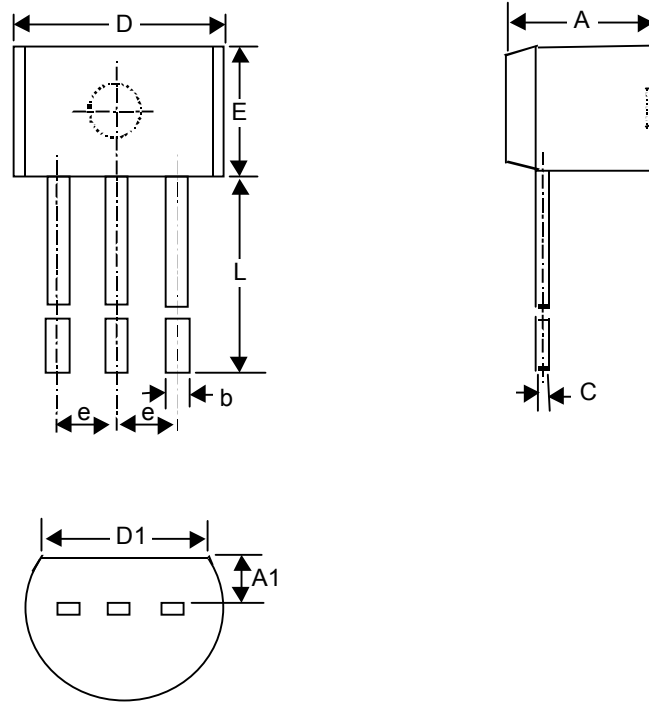

Symbol	Dimensions In Millimeters		Dimensions In Inches	
	Min	Max	Min	Max
A	3.175	4.191	0.125	0.165
A1	1.143	1.372	0.045	0.054
b	0.406	0.533	0.016	0.021
C	0.406	0.533	0.016	0.021
D	4.445	5.207	0.175	0.205
D1	3.429	--	0.135	--
E	4.318	5.334	0.170	0.210
e	1.143	1.397	0.045	0.055
L	12.700	--	0.500	--

**3-Lead TO-92 Package**

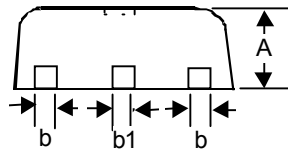
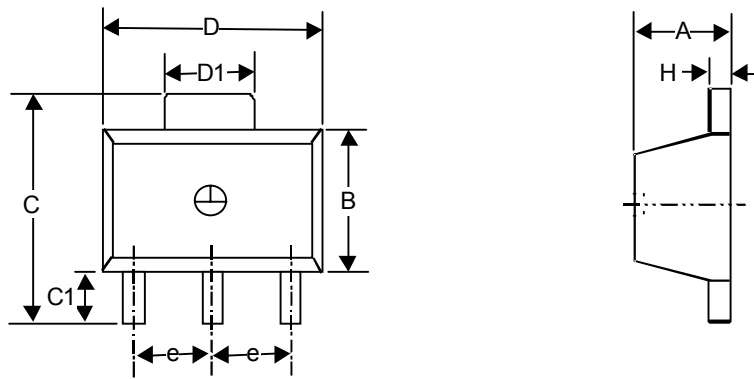

Symbol	Dimensions In Millimeters		Dimensions In Inches	
	Min	Max	Min	Max
A	1.397	1.600	0.055	0.063
b	0.356	0.483	0.014	0.019
B	2.388	2.591	0.094	0.102
b1	0.406	0.533	0.016	0.021
C	--	4.242	--	0.167
C1	0.787	1.194	0.031	0.047
D	4.394	4.597	0.173	0.181
D1	1.397	1.753	0.055	0.069
e	1.448	1.549	0.057	0.061
H	0.355	0.432	0.014	0.017

**3-Lead SOT-89 Surface Mount**

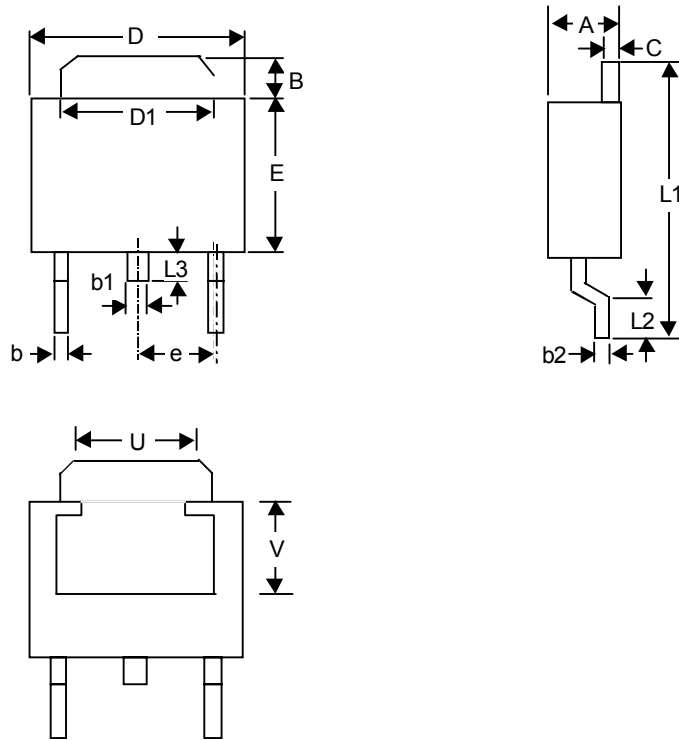

Symbol	Dimensions In Millimeters		Dimensions In Inches	
	Min	Max	Min	Max
A	2.184	2.388	0.086	0.094
B	0.889	2.032	0.035	0.080
b	0.508	0.889	0.020	0.035
b1	1.016 Ref.		0.040 Ref.	
b2	0.457	0.584	0.018	0.023
C	0.457	0.584	0.018	0.023
D	6.350	6.731	0.250	0.265
D1	5.207	5.461	0.205	0.215
E	5.334	6.223	0.210	0.245
e	2.108	2.438	0.083	0.096
L1	9.398	10.414	0.370	0.410
L2	0.508	--	0.020	--
L3	0.635	1.016	0.025	0.040
U	3.810 Ref.		0.150 Ref.	
V	3.048 Ref.		0.120 Ref.	

**3-Lead TO-252 Plastic Surface Mount Package**

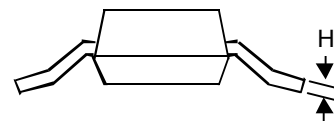
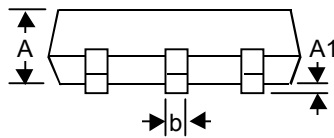
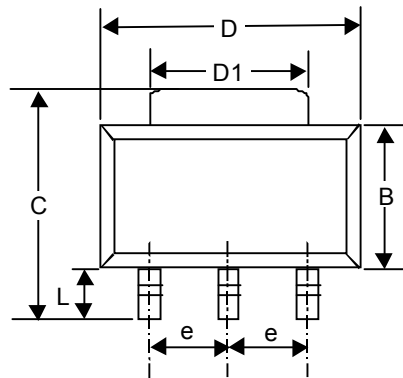

Symbol	Dimensions In Millimeters		Dimensions In Inches	
	Min	Max	Min	Max
A	--	1.803	--	0.071
A1	0.020	0.100	0.0008	0.0047
b	0.610	0.787	0.024	0.031
B	3.302	3.708	0.130	0.146
C	6.706	7.290	0.264	0.287
D	6.299	6.706	0.248	0.264
D1	2.896	3.150	0.114	0.124
e	2.261	2.362	0.089	0.093
H	0.229	0.330	0.009	0.013
L	0.914	--	0.036	--

**3-Lead SOT-223 Plastic Surface Mount**

**RICHTEK TECHNOLOGY CORP.**

Headquarter

6F, No. 35, Hsintai Road, Chupei City

Hsinchu, Taiwan, R.O.C.

Tel: (8863)5510047 Fax: (8863)5537749

**RICHTEK TECHNOLOGY CORP.**

Taipei Office (Marketing)

8F-1, No. 137, Lane 235, Paochiao Road, Hsintien City

Taipei County, Taiwan, R.O.C.

Tel: (8862)89191466 Fax: (8862)89191465

Email: [marketing@richtek-ic.com.tw](mailto:marketing@richtek-ic.com.tw)