



# MAX2560/MAX2566/MAX2572 Evaluation Kits

## General Description

The MAX2560/MAX2566/MAX2572 evaluation kits (EV kits) simplify testing of the MAX2560/MAX2566/MAX2572. The EV kits provide 50Ω SMA connectors for all RF inputs, baseband inputs, and RF outputs. On-board VCOs are provided for the on-chip PLLs.

The EV kits allow evaluation of the MAX2560/MAX2566/MAX2572s' I/Q modulator, RF upconverter, IF and RF VGAs, IF and RF PLLs, 3-wire programmable interface, and power-management features.

The MAX2560/MAX2566/MAX2572 support CDMA, TDMA, and EDGE modes for US PCS and cellular bands, as well as W-CDMA mode for UMTS band. The MAX2566/MAX2572 also support GSM-GPRS mode for all four bands.

## Features

- ◆ On-Board PCS and Cellular VCOs
- ◆ WCDMA, GSM900, DCS1800, GSM1900 Modes (MAX2566/MAX2572 EV Kits)
- ◆ 50Ω SMA Connectors on All RF and Baseband Ports
- ◆ Low-Power Shutdown Mode
- ◆ EV-Kit Control Software Available at [www.maxim-ic.com](http://www.maxim-ic.com)
- ◆ SPI™/QSPI™/MICROWIRE™ Compatible

## Ordering Information

PART	TEMP RANGE	IC PACKAGE
MAX2560EVKIT	-40°C to +85°C	48 QFN-EP*
MAX2566EVKIT	-40°C to +85°C	48 QFN-EP*
MAX2572EVKIT	-40°C to +85°C	48 QFN-EP*

\*EP = Exposed paddle.

## Component Suppliers

SUPPLIER	PHONE	FAX	WEBSITE
AVX	803-946-0690	803-626-3123	<a href="http://www.avxcorp.com">www.avxcorp.com</a>
Coilcraft	847-639-6400	847-639-1469	<a href="http://www.coilcraft.com">www.coilcraft.com</a>
Murata	770-436-1300	770-436-3030	<a href="http://www.murata.com">www.murata.com</a>
Taiyo Yuden	408-573-4150	408-573-4159	<a href="http://www.t-yuden.com">www.t-yuden.com</a>
TOKO	708-297-0070	708-699-1194	<a href="http://www.toko.com">www.toko.com</a>

**Note:** Indicate that you are using the MAX2560/MAX2566/MAX2572 when contacting these component suppliers.

## MAX2560 Component List

DESIGNATION	QTY	DESCRIPTION
C1	1	4.7pF ±0.1pF ceramic capacitor (0402) Murata GRP1555C1H4R7B
C2, C4, C39	3	33pF ±5% ceramic capacitors (0402) Murata GRP1555C1H330J
C3, C7, C116	3	10μF ±10% ceramic capacitors (1206) Murata GRM31CR60J106K
C5	1	6.8pF ±0.1pF capacitor (0402) Murata GRP1555C1H6R8B

DESIGNATION	QTY	DESCRIPTION
C6, C8, C9, C11, C12, C14, C15, C17, C18, C20, C27, C28, C29, C34, C35, C47, C48, C50, C51, C53, C54, C56, C58, C59, C64, C66, C93, C94, C102-C106, C112-C115	37	Open
C10	1	3.3μF ±10% ceramic capacitor (0805) Murata GRM21BR60J335K
C13, C16, C31, C32, C41, C42, C55	7	0.022μF ±10% ceramic capacitors (0402) Murata GRP155R71C223K

SPI and QSPI are trademarks of Motorola, Inc.  
Microwire is a trademark of National Semiconductor Corp.



**For pricing, delivery, and ordering information, please contact Maxim/Dallas Direct! at 1-888-629-4642, or visit Maxim's website at [www.maxim-ic.com](http://www.maxim-ic.com).**

# MAX2560/MAX2566/MAX2572 Evaluation Kits

**Evaluate: MAX2560/MAX2566/MAX2572**

## MAX2560 Component List (continued)

DESIGNATION	QTY	DESCRIPTION
C21, C36, C37, C90, C100	5	1.0 $\mu$ F $\pm$ 10% ceramic capacitors (1206) Murata GRM31MR71E105K
C22, C23, C30, C43, C44, C45, C57, C82, C83, C84, C97, C98	12	1000pF $\pm$ 10% ceramic capacitors (0402) Murata GRP155R71H102K
C24	1	10pF $\pm$ 0.1pF ceramic capacitor (0402) Murata GRP1555C1H100B
C25	1	22pF $\pm$ 5% ceramic capacitor (0402) Murata GRP1555C1H220J
C26	1	4700pF $\pm$ 10% ceramic capacitor (0402) Murata GRP155R71E472K
C33, C85, C110, C111	4	100pF $\pm$ 5% ceramic capacitors (0402) Murata GRP1555C1H101J
C38	1	0.1 $\mu$ F $\pm$ 10% ceramic capacitor (0603) Murata GRM188R71E104K
C40, C67, C68, C69	4	15pF $\pm$ 5% ceramic capacitors (0402) Murata GRP1555C1H150J
C46, C60, C63	3	0.01 $\mu$ F $\pm$ 10% ceramic capacitors (0402) Murata GRP155R71E103K
C49	1	0.015 $\mu$ F $\pm$ 10% ceramic capacitor (0402) Murata GRP155R71C153K
C52	1	0.33 $\mu$ F $\pm$ 10% ceramic capacitor (1206) Murata GRM319R71H334K
C61	1	220pF $\pm$ 10% ceramic capacitor (0402) Murata GRP155R71H221K
C62	1	2200pF $\pm$ 10% ceramic capacitor (0402) Murata GRP155R71H222K
C65	1	0.47 $\mu$ F $\pm$ 10% ceramic capacitor (0402) Murata GRP155R60J474K
C70, C73, C75	3	1.0 $\mu$ F $\pm$ 10% tantalum capacitors A case AVX TAJA105K016
C72	1	1.0 $\mu$ F $\pm$ 10% ceramic capacitor (0402) Murata GRP155R60J105K
C74, C88, C89	3	0.1 $\mu$ F $\pm$ 10% ceramic capacitors (0805) Murata GRM21BR71H104K
C76, C77, C101, C109	4	0.01 $\mu$ F $\pm$ 10% ceramic capacitors (0805) Murata GRM216R71H103K

DESIGNATION	QTY	DESCRIPTION
C86	1	47pF $\pm$ 5% ceramic capacitor (0402) Murata GRP1555C1H470J
C87	1	39pF $\pm$ 5% (0402) ceramic capacitor Murata GRP1555C1H390J
C91, C92, C95	3	56pF $\pm$ 5% ceramic capacitors (0402) Murata GRP1555C1H560J
C96, C99	2	22 $\mu$ F $\pm$ 10% ceramic capacitors (1206) Murata GRM31CR60J226K
J1, J2, J7–J11, J15, J16, J17, J59	11	SMA edge mount connectors—round contacts Johnson 142-0701-801
J3, J6, J33	3	Open
J4, J5, J18–J22, J31, JU6–JU10, JU12, JU14, JU16–JU23, JU28–JU31	27	1 x 2, 2-pin in-line headers, 100-mil centers Sullins PTC36SAAN
J24	1	2 x 10, dual in-line header, 100-mil centers Sullins PTC36DAAN
JU24	1	1 x 5, 5-pin header, 100-mil centers Sullins PTC36SAAN
JU1–JU5, JU11, JU13, JU15	8	1 x 3, 3-pin in-line headers, 100-mil centers Sullins PTC36SAAN
JU25, JU26, JU27, JU32, JU33, JU34	6	Open
J12, J13, J14, TP1, TP2, TP3, TP5, TP6, TP7	9	Test points Keystone 5000
L1	1	3.9nH $\pm$ 0.3nH inductor (0402) Murata LQG15HN3N9S00
L2	1	3.3nH $\pm$ 0.3nH inductor (0402) Murata LQG15HN3N3S00

# MAX2560/MAX2566/MAX2572 Evaluation Kits

## MAX2560 Component List (continued)

DESIGNATION	QTY	DESCRIPTION
L3, L4, L12, L13, L14	5	Open
L7, L8	2	15nH $\pm$ 3% inductors (0402) Murata LQW15AN15NH00
L9, L10	2	8.2nH $\pm$ 5% inductors (0402) Coilcraft 0402CS-8N2XJB
L15	1	33nH $\pm$ 5% inductor (0402) Murata LQG15HN33NJ00
L16, L17	2	12nH $\pm$ 2% inductors (0402) Murata LQP15MN12NG02
L18	1	22nH $\pm$ 5% inductor (0402) Murata LQG15HN22NJ00
L19	1	27nH $\pm$ 5% inductor (0402) Murata LQG15HN27NJ00
R1, R2, R3, R5, R7, R10–R13, R18, R20, R23, R25, R27, R28, R38, R46, R48, R49, R51–R54, R56, R57, R59	26	Open
R4, R8, R9	3	3.3 $\Omega$ $\pm$ 5% resistors (0402)
R6	1	10k $\Omega$ $\pm$ 10% variable resistor Bournes 3296W-103
R14	1	2.7k $\Omega$ $\pm$ 5% resistor (0402)
R15, R16, R17, R22, R26, R55, R70, R76–R79	11	0 $\Omega$ $\pm$ 5% resistors (0402)
R19	1	20 $\Omega$ $\pm$ 1% resistor (0402)
R21	1	6.8 $\Omega$ $\pm$ 5% resistor (0402)
R24	1	100 $\Omega$ $\pm$ 5% resistor (0402)
R39	1	13k $\Omega$ $\pm$ 1% resistor (0402)
R40, R45, R96, R97, R98, R104, R107	7	1k $\Omega$ $\pm$ 1% resistors (0402)
R47	1	220 $\Omega$ $\pm$ 5% resistor (0402)

DESIGNATION	QTY	DESCRIPTION
R50	1	200 $\Omega$ $\pm$ 5% resistor (0402)
R58	1	7.5k $\Omega$ $\pm$ 5% resistor (0402)
R61, R63–R68	7	5.1k $\Omega$ $\pm$ 5% resistors (0402)
R62	1	51 $\Omega$ $\pm$ 5% resistor (0402)
R99, R100, R101, R102	4	511 $\Omega$ $\pm$ 1% resistors (0402)
R103, R108	2	3.16k $\Omega$ $\pm$ 1% resistors (0402)
R105, R106	2	22.1 $\Omega$ $\pm$ 1% resistors (0402)
R109, R110	2	1.2k $\Omega$ $\pm$ 5% resistors (0402)
T3	1	Open
T5, T6	2	Balun transformers B5F TOKO 458DB-1011
U1	1	MAX2560 48-pin QFN MAX2560EGM
U2	1	Open
U4	1	Open
U5	1	Open
U6	1	Open
U7, U8, U9	3	SOT23 SOT23-5L MAX8867EUK28
U10	1	VCO Fujitsu VC-2R8A50-2139
U11, U12	2	Low-voltage precision op amps MAX412CSA
Y1	1	19.2MHz VC TCXO Kinseki VC-TCXO-208C-19P2
None	1	36in socket connector ribbon cable—20 contacts
None	1	INTF2300 interface board
None	1	MAX2562/MAX2566/MAX2572 EV kit circuit board rev 3
None	1	MAX2560/MAX2566/MAX2572 data sheet
None	1	MAX2560/MAX2566/MAX2572 EV kit data sheet

Evaluate: MAX2560/MAX2566/MAX2572

# MAX2560/MAX2566/MAX2572 Evaluation Kits

**Evaluate: MAX2560/MAX2566/MAX2572**

## MAX2566 Component List

DESIGNATION	QTY	DESCRIPTION
C1	1	4.7pF ±0.1pF ceramic capacitor (0402) Murata GRP1555C1H4R7B
C2, C4, C39	3	33pF ±5% ceramic capacitors (0402) Murata GRP1555C1H330J
C3, C7, C116	3	10µF ±10% ceramic capacitors (1206) Murata GRM31CR60J106K
C5	1	6.8pF ±0.1pF ceramic capacitor (0402) Murata GRP1555C1H6R8B
C6, C91, C92	3	56pF ±5% ceramic capacitors (0402) Murata GRP1555C1H560J
C8, C10, C11, C20, C27, C29, C34, C47, C48, C50, C51, C53–C59, C64, C93, C94, C95	22	Open
C9, C13, C16, C17, C18, C22, C23, C30, C32, C43, C44, C45, C49, C82, C83, C84, C97, C98	18	1000pF ±10% ceramic capacitors (0402) Murata GRP155R71H102K
C12	1	270pF ±10% ceramic capacitor (0402) Murata GRP155R71H271K
C14, C112–C115	5	680pF ±10% ceramic capacitors (0402) Murata GRP155R71H681K
C15, C62	2	6800pF ±10% ceramic capacitors (0402) Murata GRP155R71E682K
C21, C36, C37, C90, C100	5	1.0µF ±10% ceramic capacitors (1206) Murata GRM31MR71E105K
C24, C35	2	10pF ±0.1pF ceramic capacitors (0402) Murata GRP1555C1H100B
C25	1	12pF ±5% ceramic capacitor (0402) Murata GRP1555C1H120J
C26, C55	2	4700pF ±10% ceramic capacitors (0402) Murata GRP155R71E472K
C28	1	470pF ±10% ceramic capacitor (0402) Murata GRP155R71H471K

DESIGNATION	QTY	DESCRIPTION
C31	1	0.022µF ±10% ceramic capacitor (0402) Murata GRP155R71C223K
C33, C41, C42, C85, C105, C106, C110, C111	8	100pF ±5% ceramic capacitors (0402) Murata RP1555C1H101J
C38	1	0.1µF ±10% ceramic capacitor (0603) Murata GRM188R71E104K
C40, C67, C68, C69	4	15pF ±5% ceramic capacitors (0402) Murata GRP1555C1H150J
C46, C60, C63	3	0.01µF ±10% ceramic capacitors (0402) Murata GRP155R71E103K
C52	1	0.033µF ±5% film capacitor (1206) Panasonic ECHU1C333JX5
C61	1	2200pF ±10% ceramic capacitor (0402) Murata GRP155R71H222K
C65	1	0.47µF ±10% ceramic capacitor (0402) Murata GRP155R60J474K
C66	1	1.0pF ±0.1pF ceramic capacitor (0402) Murata GRP1555C1H1R0B
C70, C73, C75	3	1.0µF ±10% tantalum capacitors A Case AVX TAJA105K016
C72	1	1.0µF ±10% ceramic capacitor (0402) Murata GRP155R60J105K
C74, C88, C89	3	0.1µF ±10% ceramic capacitors (0805) Murata GRM21BR71H104K
C76, C77, C101, C109	4	0.01µF ±10% ceramic capacitors (0805) Murata GRM216R71H103K
C86, C87	2	8.0pF ±0.1pF ceramic capacitors (0402) Murata GRP1555C1H8R0B
C96, C99	2	22µF ±10% ceramic capacitors (1206) Murata GRM31CR60J226K
C102	1	27pF ±5% ceramic capacitor (0402) Murata GRP1555C1H270J
C103, C104	2	2.2pF ±0.1pF ceramic capacitors (0402) Murata GRP1555C1H2R2B

# MAX2560/MAX2566/MAX2572 Evaluation Kits

## MAX2566 Component List (continued)

DESIGNATION	QTY	DESCRIPTION
J1, J2, J3, J6–J11, J15, J16, J17, J33, J59	14	SMA edge-mount connectors—round contacts Johnson 142-0701-801
J24	1	2 x 10, dual in-line header, 100-mil centers Sullins PTC36DAAN
J4, J5, J18–J22, J31, JU6–JU10, JU12, JU14, JU16–JU23, JU28–JU31	27	1 x 2, 2-pin in-line headers, 100-mil centers Sullins PTC36SAAN
JU24	1	1 x 5, 5-pin header, 100-mil centers Sullins PTC36SAAN
JU1–JU5, JU11, JU13, JU15, JU25, JU26, JU27, JU32	12	1 x 3, 3-pin in-line headers, 100-mil centers Sullins PTC36SAAN
JU33, JU34	2	Open
J12, J13, J14, TP1, TP2, TP3, TP5, TP6, TP7	9	Test points Keystone 5000
L1	1	3.3nH $\pm 0.2$ nH inductor (0402) Murata LQP15MN3N3C00
L2	1	2.2nH $\pm 0.3$ nH inductor (0402) Murata LQG15HN2N2S00
L3, L4	2	100nH $\pm 5\%$ inductors (0402) TOKO LLV1005-FBR10J
L7, L8	2	5.6nH $\pm 5\%$ inductors (0402) Coilcraft 0402CS-5N6XJB
L9, L10, L13	3	9nH $\pm 5\%$ inductors (0402) Coilcraft 0402CS-9N0XJB
L12	1	27pF $\pm 5\%$ ceramic capacitor (0402) Murata GRP1555C1H270J
L14	1	15nH $\pm 5\%$ inductor (0402) Murata LQG15HN15NJ00
L15	1	33nH $\pm 2\%$ inductor (0402) Murata LQP15MN33NG00

DESIGNATION	QTY	DESCRIPTION
L16	1	7.5nH $\pm 5\%$ inductor (0402) Coilcraft 0402CS-7N5XJB
L17	1	5.1nH $\pm 5\%$ inductor (0402) Coilcraft 0402CS-5N1XJB
L18	1	22nH $\pm 5\%$ inductor (0402) Murata LQG15HN22NJ00
L19	1	12nH $\pm 5\%$ inductor (0402) Murata LQG15HN12NJ00
R1, R6	2	10k $\Omega$ $\pm 10\%$ variable resistors Bournes 3296W-1-103
R2, R3	2	150 $\Omega$ $\pm 5\%$ resistors (0402)
R4, R8, R9	3	3.3 $\Omega$ $\pm 5\%$ resistors (0402)
R5, R15, R16, R17, R19, R20, R23, R24, R25, R27, R28, R38, R46, R48, R49, R51–R57, R59	23	Open
R7, R18, R22, R26, R76–R79	8	0 $\Omega$ $\pm 5\%$ resistors (0402)
R10	1	56 $\Omega$ $\pm 5\%$ resistor (0402)
R11	1	1M $\Omega$ $\pm 5\%$ resistor (0402)
R13, R45, R96, R97, R98	5	100 $\Omega$ $\pm 1\%$ resistors (0402)
R14	1	2.7k $\Omega$ $\pm 5\%$ resistor (0402)
R21	1	6.8 $\Omega$ $\pm 5\%$ resistor (0402)
R39	1	13k $\Omega$ $\pm 1\%$ resistor (0402)
R40, R104, R107	3	1k $\Omega$ $\pm 5\%$ resistors (0402)
R47	1	365 $\Omega$ $\pm 1\%$ resistor (0402)
R50	1	430 $\Omega$ $\pm 5\%$ resistor (0402)
R58	1	2.0k $\Omega$ $\pm 5\%$ resistor (0402)
R61, R63–R68, R70	8	5.1k $\Omega$ $\pm 5\%$ resistors (0402)
R62	1	51 $\Omega$ $\pm 5\%$ resistor (0402)
R99, R100–R103, R108	6	511 $\Omega$ $\pm 1\%$ resistors (0402)
R105, R106	2	39 $\Omega$ $\pm 5\%$ resistors (0402)
R109, R110	2	680 $\Omega$ $\pm 5\%$ resistors (0402)

Evaluate: MAX2560/MAX2566/MAX2572

# MAX2560/MAX2566/MAX2572 Evaluation Kits

## MAX2566 Component List (continued)

DESIGNATION	QTY	DESCRIPTION
T3, T5, T6	3	Transformers B5F TOKO 458DB-1011
U1	1	MAX2566 48-pin QFN MAX2566EGM
U2	1	GSM VCO Murata MQT1C1A897M
U4	1	Open
U5	1	Open
U6	1	Open
U7, U8, U9	3	SOT23 SOT23-5L MAX8867EUK28
U10	1	Open
U11, U12	2	Low-voltage, precision op amps MAX412CSA

DESIGNATION	QTY	DESCRIPTION
Y1	1	13.0MHz VC TCXO Kinseki VC-TCXO-208C-13P0
None	1	36in socket connector ribbon cable—20 contacts
None	1	INTF2300 interface board
None	1	MAX2562/MAX2566/MAX2572 EV kit circuit board rev 3
None	1	MAX2560/MAX2566/MAX2572 data sheet
None	1	MAX2560/MAX2566/MAX2572 EV kit data sheet

## MAX2572 Component List

DESIGNATION	QTY	DESCRIPTION
C1	1	4.7pF $\pm 0.1$ pF ceramic capacitor (0402) Murata GRP1555C1H4R7B
C2, C4, C39	3	33pF $\pm 5\%$ ceramic capacitors (0402) Murata GRP1555C1H330J
C3, C7, C116	3	10 $\mu$ F $\pm 10\%$ ceramic capacitors (1206) Murata GRM31CR60J106K
C5	1	6.8pF $\pm 0.1$ pF ceramic capacitor (0402) Murata GRP1555C1H6R8B
C6, C8, C91–C95	7	56pF $\pm 5\%$ ceramic capacitors (0402) Murata GRP1555C1H560J
C9, C11, C13, C16, C17, C18, C22, C23, C30, C32, C43, C44, C45, C56–C59, C82, C83, C84, C97, C98	22	1000pF $\pm 10\%$ ceramic capacitors (0402) Murata GRP155R71H102K

DESIGNATION	QTY	DESCRIPTION
C10, C20	2	3.3 $\mu$ F $\pm 10\%$ ceramic capacitors (0805) Murata GRM21BR60J335K
C27, C34, C64	3	Open
C12	1	270pF $\pm 10\%$ ceramic capacitor (0402) Murata GRP155R71H271K
C14, C48, C49, C50, C112–C115	8	680pF $\pm 10\%$ ceramic capacitors (0402) Murata GRP155R71H681K
C15, C62	2	6800pF $\pm 10\%$ ceramic capacitors (0402) Murata GRP155R71E682K
C21, C36, C37, C90, C100	5	1.0 $\mu$ F $\pm 10\%$ ceramic capacitors (1206) Murata GRM31MR71E105K
C24, C35	2	10pF $\pm 0.1$ pF ceramic capacitors (0402) Murata GRP1555C1H100B
C25	1	12pF $\pm 5\%$ ceramic capacitor (0402) Murata GRP1555C1H120J

# MAX2560/MAX2566/MAX2572 Evaluation Kits

## MAX2572 Component List (continued)

DESIGNATION	QTY	DESCRIPTION
C26	1	4700pF ±10% ceramic capacitor (0402) Murata GRP155R71E472K
C28, C29, C47	3	470pF ±10% ceramic capacitors (0402) Murata GRP155R71H471K
C31, C51	2	0.022µF ±10% ceramic capacitors (0402) Murata GRP155R71C223K
C33, C41, C42, C85, C105, C106, C110, C111	8	100pF ±5% ceramic capacitors (0402) Murata GRP1555C1H101J
C38	1	0.1µF ±10% ceramic capacitor (0603) Murata GRM188R71E104K
C40, C67, C68, C69	4	15pF ±5% ceramic capacitors (0402) Murata GRP1555C1H150J
C46, C60, C63	3	0.01µF ±10% ceramic capacitors (0402) Murata GRP155R71E103K
C52, C53	2	0.022µF ±5% film capacitors (1206) Panasonic ECHU1C223JX5
C54, C55	2	1500pF ±10% ceramic capacitors (0402) Murata GRP155R71H152K
C61	1	2200pF ±10% ceramic capacitor (0402) Murata GRP155R71H222K
C65	1	0.47µF ±10% ceramic capacitor (0402) Murata GRP155R60J474K
C66	1	1.0pF ±0.1pF ceramic capacitor (0402) Murata GRP1555C1H1R0B
C70, C73, C75	3	1.0µF ±10% tantalum capacitors A case AVX TAJA105K016
C72	1	1.0µF ±10% ceramic capacitor (0402) Murata GRP155R60J105K
C74, C88, C89	3	0.1µF ±10% ceramic capacitors (0805) Murata GRM21BR71H104K
C76, C77, C101, C109	4	0.01µF ±10% ceramic capacitors (0805) Murata GRM216R71H103K
C86, C87	2	8.0pF ±0.1pF ceramic capacitors (0402) Murata GRP1555C1H8R0B
C96, C99	2	22µF ±10% ceramic capacitors (1206) Murata GRM31CR60J226K

DESIGNATION	QTY	DESCRIPTION
C102	1	27pF ±5% ceramic capacitor (0402) Murata GRP1555C1H270J
C103, C104	2	2.2pF ±0.1pF ceramic capacitors (0402) Murata GRP1555C1H2R2B
J1, J2, J3, J6–J11, J15, J16, J17, J33, J59	14	SMA edge-mount connectors—round contact Johnson 142-0701-801
J24	1	2 x 10, dual in-line header, 100-mil centers Sullins PTC36DAAN
J4, J5, J18–J22, J31, JU6–JU10, JU12, JU14, JU16–JU23, JU28–JU31	27	1 x 2, 2-pin in-line headers, 100-mil centers Sullins PTC36SAAN
JU24	1	1 x 5, 5-pin in-line header, 100-mil centers Sullins PTC36SAAN
JU1–JU5, JU11, JU13, JU15, JU25, JU26, JU27, JU32, JU33, JU34	14	1 x 3, 3-pin in-line headers, 100-mil centers Sullins PTC36SAAN
J12, J13, J14, TP1, TP2, TP3, TP5, TP6, TP7	9	Test points Keystone 5000
L1	1	3.3nH ±0.2nH inductor (0402) Murata LQP15MN3N3C00
L2	1	2.2nH ±0.3nH inductor (0402) Murata LQG15HN2N2S00
L3, L4	2	100nH ±5% inductors (0402) TOKO LLV1005-FBR10J
L7, L8	2	5.6nH ±5% inductors (0402) Coilcraft 0402CS-5N6XJB
L9, L10, L13	3	9nH ±5% inductors (0402) Coilcraft 0402CS-9N0XJB

Evaluate: MAX2560/MAX2566/MAX2572

# MAX2560/MAX2566/MAX2572 Evaluation Kits

**Evaluate: MAX2560/MAX2566/MAX2572**

## MAX2572 Component List (continued)

DESIGNATION	QTY	DESCRIPTION
L12	1	27pF $\pm 5\%$ ceramic capacitor (0402) Murata GRP1555C1H270J
L14	1	15nH $\pm 5\%$ inductor (0402) Murata LQG15HN15NJ00
L15	1	33nH $\pm 2\%$ inductor (0402) Murata LQP15MN33NG00
L16	1	7.5nH $\pm 5\%$ inductor (0402) Coilcraft 0402CS-7N5XJB
L17	1	5.1nH $\pm 5\%$ inductor (0402) Coilcraft 0402CS-5N1XJB
L18	1	22nH $\pm 5\%$ inductor (0402) Murata LQG15HN22NJ00
L19	1	12nH $\pm 5\%$ inductor (0402) Murata LQG15HN12NJ00
R1, R6	2	10k $\Omega$ $\pm 10\%$ variable resistors Bournes 3296W-1-103
R2, R3	2	150 $\Omega$ $\pm 5\%$ resistors (0402)
R4, R8, R9	3	3.3 $\Omega$ $\pm 5\%$ resistors (0402)
R5, R7, R18, R22–R27, R76–R79	13	0 $\Omega$ $\pm 5\%$ resistors (0402)
R10	1	56 $\Omega$ $\pm 5\%$ resistor (0402)
R11	1	1M $\Omega$ $\pm 5\%$ resistor (0402)
R12	1	33 $\Omega$ $\pm 5\%$ resistor (0402)
R13, R14, R45, R96, R97, R98	6	100 $\Omega$ $\pm 1\%$ resistors (0402)
R15, R16, R17, R38, R52, R53, R54, R56, R59	9	Open
R19, R20	2	20 $\Omega$ $\pm 1\%$ resistors (0402)
R21	1	6.8 $\Omega$ $\pm 5\%$ resistor (0402)
R28	1	576 $\Omega$ $\pm 5\%$ resistor (0402)
R39	1	13k $\Omega$ $\pm 1\%$ resistor (0402)
R40, R104, R107	3	1k $\Omega$ $\pm 5\%$ resistors (0402)
R46	1	430 $\Omega$ $\pm 5\%$ resistor (0402)
R47, R48	2	510 $\Omega$ $\pm 5\%$ resistors (0402)
R49, R50	2	360 $\Omega$ $\pm 5\%$ resistors (0402)

DESIGNATION	QTY	DESCRIPTION
R51	1	330 $\Omega$ $\pm 5\%$ resistor (0402)
R55, R57	2	576 $\Omega$ $\pm 1\%$ resistors (0402)
R58	1	2.0k $\Omega$ $\pm 5\%$ resistor (0402)
R61, R63–R68, R70	8	5.1k $\Omega$ $\pm 5\%$ resistors (0402)
R62	1	51 $\Omega$ $\pm 5\%$ resistor (0402)
R99–R103, R108	6	511 $\Omega$ $\pm 1\%$ resistors (0402)
R105, R106	2	39 $\Omega$ $\pm 5\%$ resistors (0402)
R109, R110	2	680 $\Omega$ $\pm 5\%$ resistors (0402)
T3, T5, T6	3	Balun transformers B5F TOKO 458DB-1011
U1	1	MAX2572 48-pin QFN
U2	1	GSM VCO Murata MQT1C1A897M
U4	1	UMTS VCO Murata MQK301-1528
U5	1	VCO Murata MQE956A1G32
U6	1	GSM/DCS VCO Murata MQW140A1G23
U7, U8, U9	3	SOT23-5L MAX8867EUK28
U10	1	Open
U11, U12	2	Low-voltage precision op amps MAX412CSA
Y1	1	13.0MHz VC TCXO Kinseki VC-TCXO-208C-13P0
None	1	36in socket connector ribbon cable—20 contacts
None	1	INTF2300 interface board
None	1	MAX2560/MAX2566/MAX2572 EV kit circuit board rev 3
None	1	MAX2560/MAX2566/MAX2572 data sheet
None	1	MAX2560/MAX2566/MAX2572 EV kit data sheet



# MAX2560/MAX2566/MAX2572 Evaluation Kits

## Quick Start

The MAX2560/MAX2566/MAX2572 EV kits are fully assembled and factory tested. Follow the instructions in the *Connections and Setup* section.

## Test Equipment Required

This section lists the recommended test equipment to verify the operation of the MAX2560/MAX2566/MAX2572. It is intended as a guide only, and substitutions may be possible.

- One RF signal generator capable of delivering -5dBm of output power in the 1GHz to 3GHz frequency range (HP8648 or equivalent) for the external RF LO
- An RF spectrum analyzer with optional digital modulation personality (Rohde & Schwarz FSEA30 or equivalent)
- A power supply capable of providing 200mA at +5V
- A power supply capable of providing 50mA at 6.8V
- A power supply capable of providing -50mA at -3.2V
- I/Q arbitrary waveform generator (Agilent E4433B or equivalent)
- PC (486DX33 or better) with Windows™95/98, 2000, NT 4.0 or later operating system and an available parallel port
- INTF2300 interface board (supplied with EV kit)

## Connections and Setup

This section provides step-by-step instructions for getting the EV kit up and running in CDMA, WCDMA, and GSM modes.

- 1) Verify shunts JU6–JU22 and JU28–JU31 are in place.
- 2) Connect the INTF2300 interface cable to the EV kit.  
**Note:** Pin 1 of the interface cable corresponds to the red wire. Pin 1 is designated in silkscreen on each of the PC boards.
- 3) With the power supply turned off, connect a +5.0V power supply to the header labeled V5.0 (J31). Connect the power-supply ground to the header labeled GND (J5). (The MAX2560 requires two additional power supplies. Connect the +6.8V power supply to JU28, and connect the -3.2V to TP2. Connect the grounds to GND (J5) or GND (J20), or both.)
- 4) Install and run the MAX2560/MAX2572 control software. The MAX2566 has its own control software. Software is available for download on the Maxim website at [www.maxim-ic.com](http://www.maxim-ic.com).

*Windows is a trademark of Microsoft.*

- 5) With MAX2560/MAX2566/MAX2572 control software active in the REG screen, set the SHDN box to 0 to place the IC in shutdown mode.
- 6) Turn on the power supplies.

## Cellular CDMA Mode

Perform the following steps to evaluate the MAX2560 in the cellular CDMA mode:

- 1) Verify shunt JU24 is in the LOTDMA position.
- 2) With MAX2560/MAX2566/MAX2572 control software active in the REG screen, use Table 1 to set the operating mode to cellular CDMA. Also, change the reference frequency to 19.2MHz in the control software.
- 3) Connect the I and Q outputs of the arbitrary waveform generator to the I (J15) and Q (J16) ports. Set the generator to reverse-channel CDMA settings. Set the output voltage level to 400mV<sub>PK</sub>.
- 4) Connect RFL (J9) to the spectrum analyzer. Configure the spectrum analyzer to measure ACPR for the reverse-channel CDMA. Set the center frequency to 836MHz with 50MHz span and a +10dBm reference level.
- 5) Adjust the R6 (VGCIF) to obtain an output power of +8dBm after accounting for cable and connector loss. The ACPR in 30kHz bandwidth at ±885kHz offset should be -54dBc, and the ACPR in 30kHz bandwidth at ±1.98MHz offset should be -65dBc.

## PCS CDMA Mode

Perform the following steps to evaluate the MAX2560 in the PCS CDMA mode:

- 1) Verify shunt JU24 is in the LOTDMA position.
- 2) With MAX2560/MAX2566/MAX2572 control software active in the REG screen, use Table 1 to set the operating mode to PCS CDMA. Also, change the reference frequency to 19.2MHz in the control software.
- 3) Connect the I and Q outputs of the arbitrary waveform generator to the I (J15) and Q (J16) ports. Set the generator to reverse-channel CDMA settings. Set the output voltage level to 400mV<sub>PK</sub>.
- 4) Connect RFH0 (J1) to the spectrum analyzer. Configure the spectrum analyzer to measure ACPR for the reverse-channel CDMA. Set the center frequency to 1880MHz with 50MHz span and a +10dBm reference level.
- 5) Adjust the R6 (VGCIF) to obtain an output power of +8dBm after accounting for cable and connector loss. The ACPR in 30kHz bandwidth at ±1.25MHz offset should be -54dBc, and the ACPR in 30kHz bandwidth at ±1.98MHz offset should be -65dBc.

# MAX2560/MAX2566/MAX2572 Evaluation Kits

## WCDMA Mode

Perform the following steps to evaluate the MAX2566/MAX2572 in the WCDMA mode:

- 1) Verify shunt JU24 is in the LOUMTS position.
- 2) With MAX2560/MAX2566/MAX2572 control software active in the REG screen, use Tables 2 and 3 to set the operating mode to WCDMA.
- 3) Connect the I and Q outputs of the arbitrary waveform generator to the I (J15) and Q (J16) ports. Set the generator to WCDMA settings. Verify 300mV peak baseband signal on Q+/Q- (JU2) and I+/I- (JU1), or 600mV peak-to-peak differential.
- 4) The MAX2566 EV kit requires an external LO input. Apply an external LO 1565MHz at -10dBm to the LOH port.
- 5) Connect RFH0 (J1) to the spectrum analyzer. Configure the spectrum analyzer to measure ACPR for the uplink WCDMA. Set the center frequency to 1950MHz with 50MHz span and a +10dBm reference level.
- 6) Adjust the R1 (VGCRF) and R6 (VGCIF) (only adjust VGCIF if VGS = 1) to obtain an output power of +8dBm after accounting for cable and connector loss. The ACPR in 3.84MHz bandwidth at  $\pm 5$ MHz offset should be -49dBc, and the ACPR in 3.84MHz band-

width at  $\pm 10$ MHz offset should be -62dBc. Note that C112–C115 are disconnected for this measurement.

## GSM 900 Mode

Perform the following steps to evaluate the MAX2566/MAX2572 in the GSM 900 mode:

- 1) Verify shunts JU23–JU26 and JU33 positions with Table 4.
- 2) With MAX2560/MAX2566/MAX2572 control software active in the REG screen, use Tables 2 and 3 to set the operating mode to GSM 900 mode.
- 3) Connect the I and Q outputs of the arbitrary waveform generator to the I (J15) and Q (J16) ports. Set the generator to GSM settings. Verify 300mV peak baseband signal on Q+/Q- (JU2) and I+/I- (JU1), or 600mV peak-to-peak differential.
- 4) The MAX2566 EV kit requires an external LO input. Apply an external LO 1190MHz at -10dBm to the LOH port.
- 5) Connect GSM (J3) to the spectrum analyzer. Configure the spectrum analyzer to measure spectral mask for the GSM signal. Set the center frequency to 900MHz with 50MHz span and a +10dBm reference level.

**Table 1. MAX2560 Register Settings**

REGISTER (hex)	CELLULAR CDMA	PCS CDMA
FRAC_SYNTH	0B4FDF	0B4FDF
FRAC	020000	005555
IF_N	000497	000519
IF_SYNTH	00D830	00D830
OPCTRL	09C01F	09F49F
CONFIG	07A307	07A307
TEST	000025	000025

**Table 2. MAX2566 Register Settings**

REGISTER (hex)	WCDMA	GSM 900	DCS 1800	GSM 1900
FRAC_SYNTH	0B603B	0B602C	0B602C	0B602C
FRAC	03B13B	09D89E	09D89E	09D89E
IF_N	000302	000244	000244	000244
IF_SYNTH	00D80D	00D80D	00D80D	00D80D
OPCTRL	0DF77F	0D876F	0D876F	0D876F
CONFIG	07A103	07BD007	04BD0F	04BD0F
TEST	000025	000025	000025	000025

# MAX2560/MAX2566/MAX2572 Evaluation Kits

Evaluate: MAX2560/MAX2566/MAX2572

## DCS 1800 Mode

Perform the following steps to evaluate the MAX2566/MAX2572 in the DCS 1800 mode:

- 1) Verify shunts JU23–JU26 and JU33 positions with Table 4.
- 2) With MAX2560/MAX2566/MAX2572 control software active in the REG screen, use Tables 2 and 3 to set the operating mode to DCS 1800 mode.
- 3) Connect the I and Q outputs of the arbitrary waveform generator to the I (J15) and Q (J16) ports. Set the generator to GSM settings. Verify 300mV peak baseband signal on Q+/Q- (JU2) and I+/I- (JU1), or 600mV peak-to-peak differential.
- 4) The MAX2566 EV kit requires an external LO input. Apply an external LO 1510MHz at -10dBm to the LOH port.
- 5) Connect GSM (J33) to the spectrum analyzer. Configure the spectrum analyzer to measure spectral mask for the GSM signal. Set the center frequency to 1800MHz with 50MHz span and a +10dBm reference level.

## GSM 1900 Mode

Perform the following steps to evaluate the MAX2566/MAX2572 in the GSM 1900 mode:

- 1) Verify shunts JU23–JU26 and JU33 positions with Table 4.
- 2) With MAX2560/MAX2566/MAX2572 control software active in the REG screen, use Tables 2 and 3 to set the operating mode to GSM 1900 mode.

- 3) Connect the I and Q outputs of the arbitrary waveform generator to the I (J15) and Q (J16) ports. Set the generator to GSM settings. Verify 300mV peak baseband signal on Q+/Q- (JU2) and I+/I- (JU1), or 600mV peak-to-peak differential.
- 4) The MAX2566 EV kit requires an external LO input. Apply an external LO 1610MHz at -10dBm to the LOH port.
- 5) Connect GSM (J33) to the spectrum analyzer. Configure the spectrum analyzer to measure spectral mask for the GSM signal. Set the center frequency to 1900MHz with a +10dBm reference level.

## Layout Considerations

The MAX2560/MAX2566/MAX2572 EV kits can serve as guides for board layout. Keep PC board trace lengths as short as possible to minimize parasitics. Also, keep decoupling capacitors as close to the IC as possible with a direct connection to the ground plane.

## INTF2300 SPI Interface Board

The INTF2300 interface board is used to interface 3-wire SPI protocol from a PC's parallel port to the EV kit. This board level translates 5V logic from the PC to VCC of the EV kit (typically, this is 2.85V logic). The INTF2300 also provides buffering and EMI filtering. Its absolute maximum supply voltage is 4.6V, limited by the breakdown of the buffer IC. The recommended operating supply voltage range is +2.7V to +3.6V.

**Table 3. MAX2572 Register Settings**

REGISTER (hex)	WCDMA	GSM 900	DCS 1800	GSM 1900
FRAC_SYNTH	070778	0B075B	0B0774	0B077B
FRAC	062763	089D8A	027627	0D89D9
IF_N	000302	000244	000244	000244
IF_SYNTH	00D80D	00D80D	00D80D	00D80D
OPCTRL	0DF77F	0D876F	0D876F	0D876F
CONFIG	07A103	07BD07	04BD07	04BD0F
TEST	000000	000000	000000	000000

**Table 4. GSM Jumper Settings**

MODE	JU23	JU24	JU25	JU26	JU33
GSM 900	CLOSE	LOGSM1	LOW	LOW	LOW
DCS 1800	CLOSE	LOGSM1	LOW	HIGH	HIGH
GSM 1900	CLOSE	LOGSM1	HIGH	HIGH	HIGH

# MAX2560/MAX2566/MAX2572 Evaluation Kits

## Evaluate: MAX2560/MAX2566/MAX2572

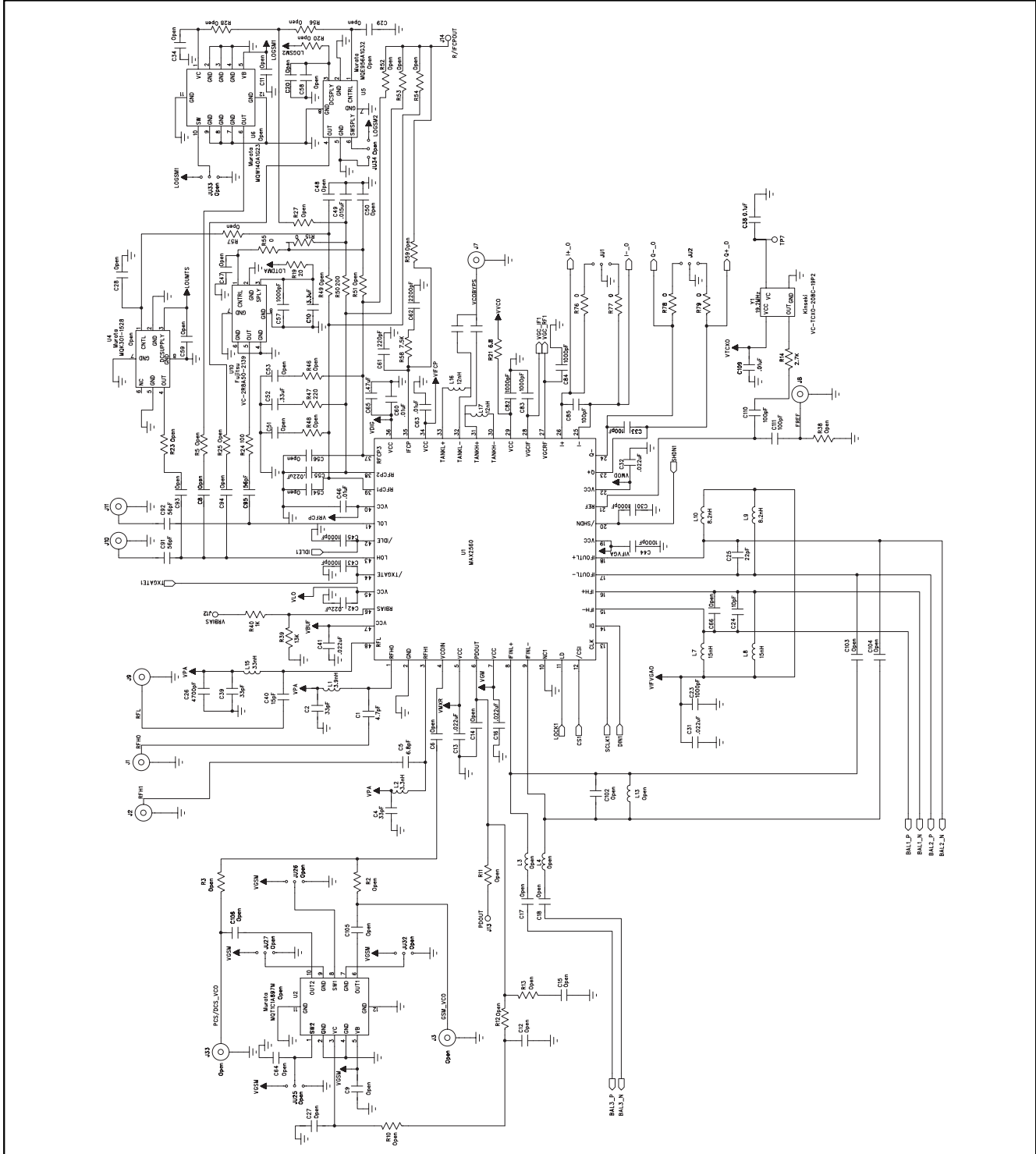

Figure 1. MAX2560 EV Kit Schematic (Sheet 1 of 3)

# MAX2560/MAX2566/MAX2572 Evaluation Kits

Evaluate: MAX2560/MAX2566/MAX2572

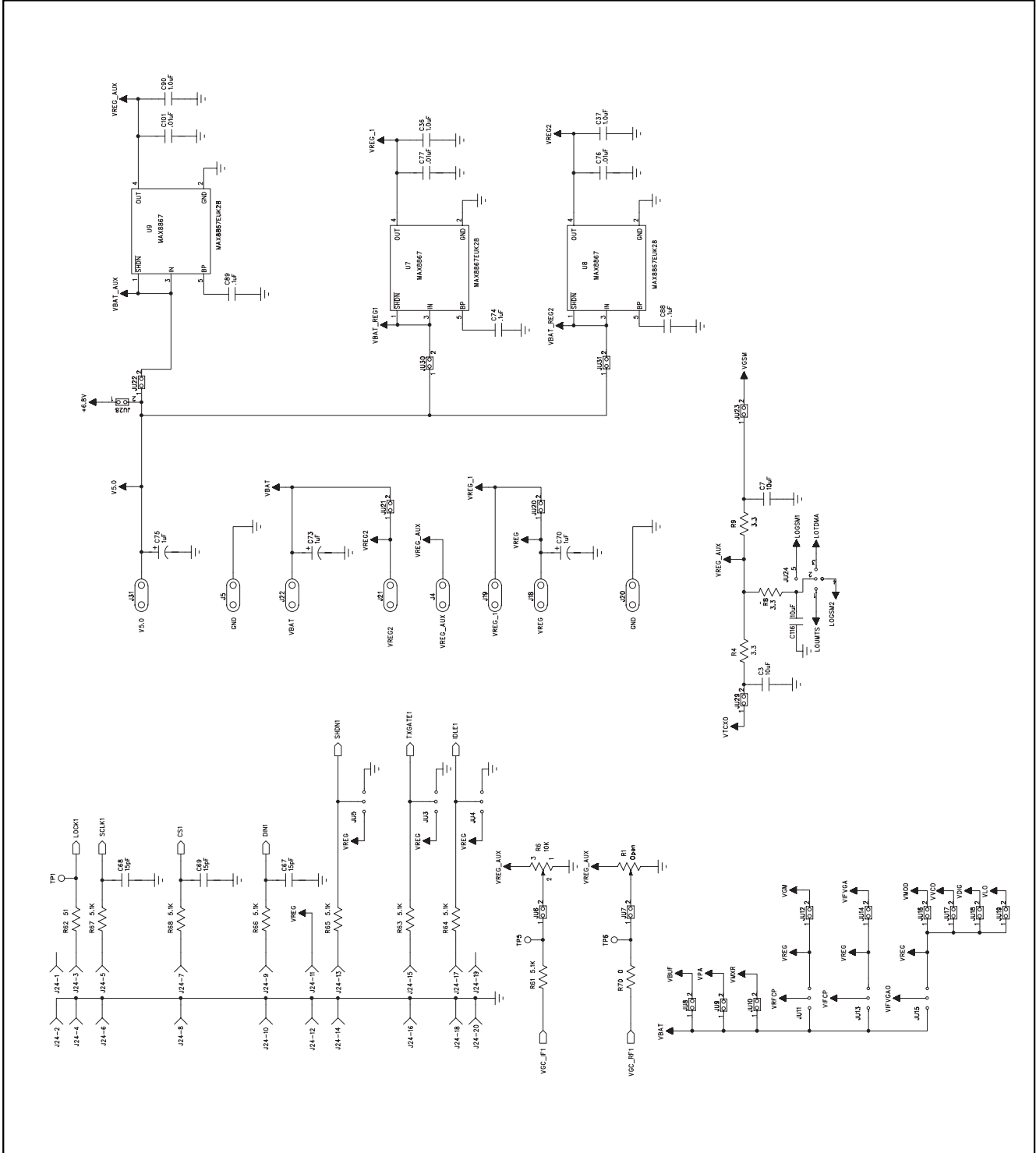

Figure 1. MAX2560 EV Kit Schematic (Sheet 2 of 3)

# MAX2560/MAX2566/MAX2572 Evaluation Kits

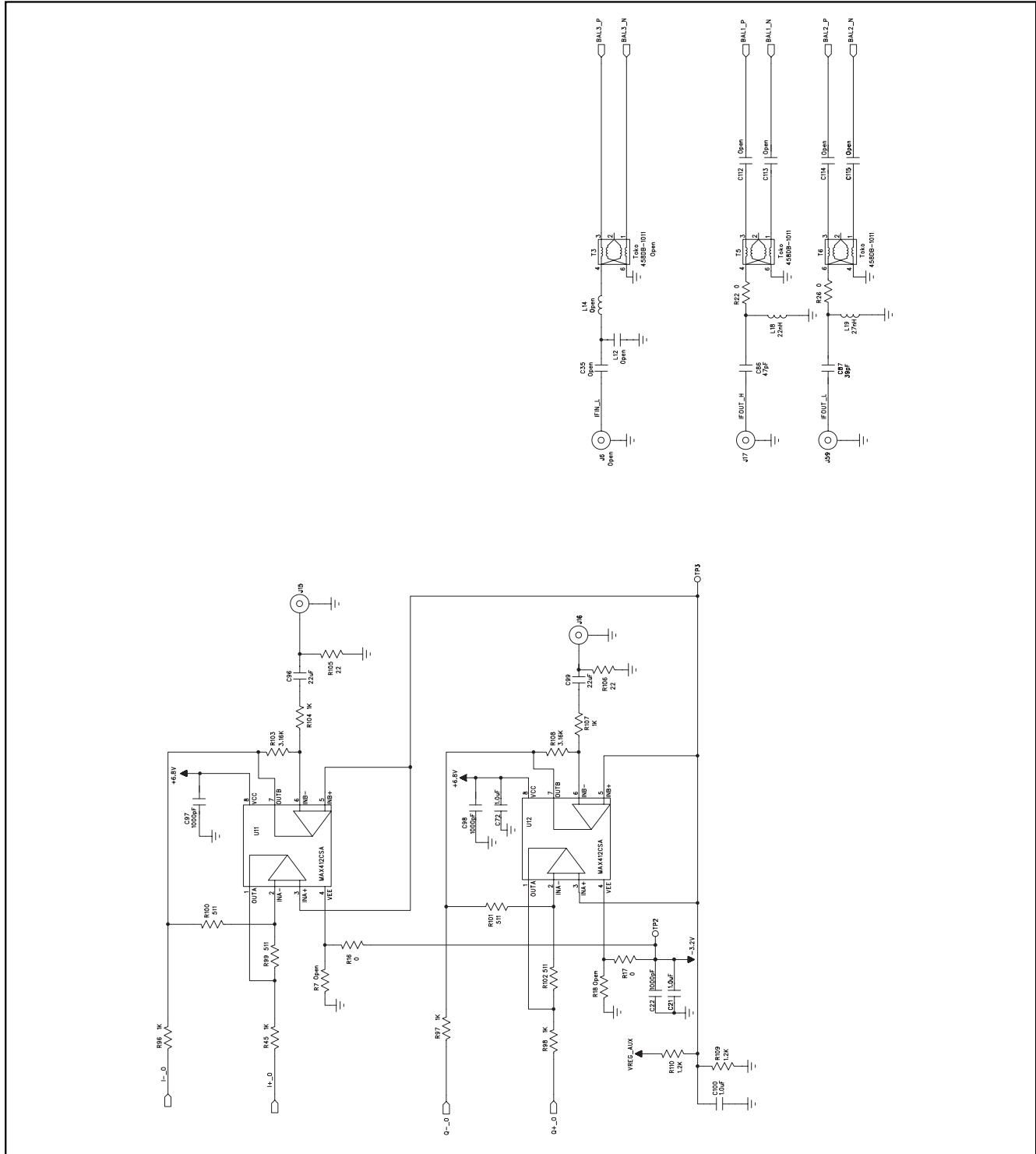

Figure 1. MAX2560 EV Kit Schematic (Sheet 3 of 3)

# MAX2560/MAX2566/MAX2572 Evaluation Kits

Evaluate: MAX2560/MAX2566/MAX2572

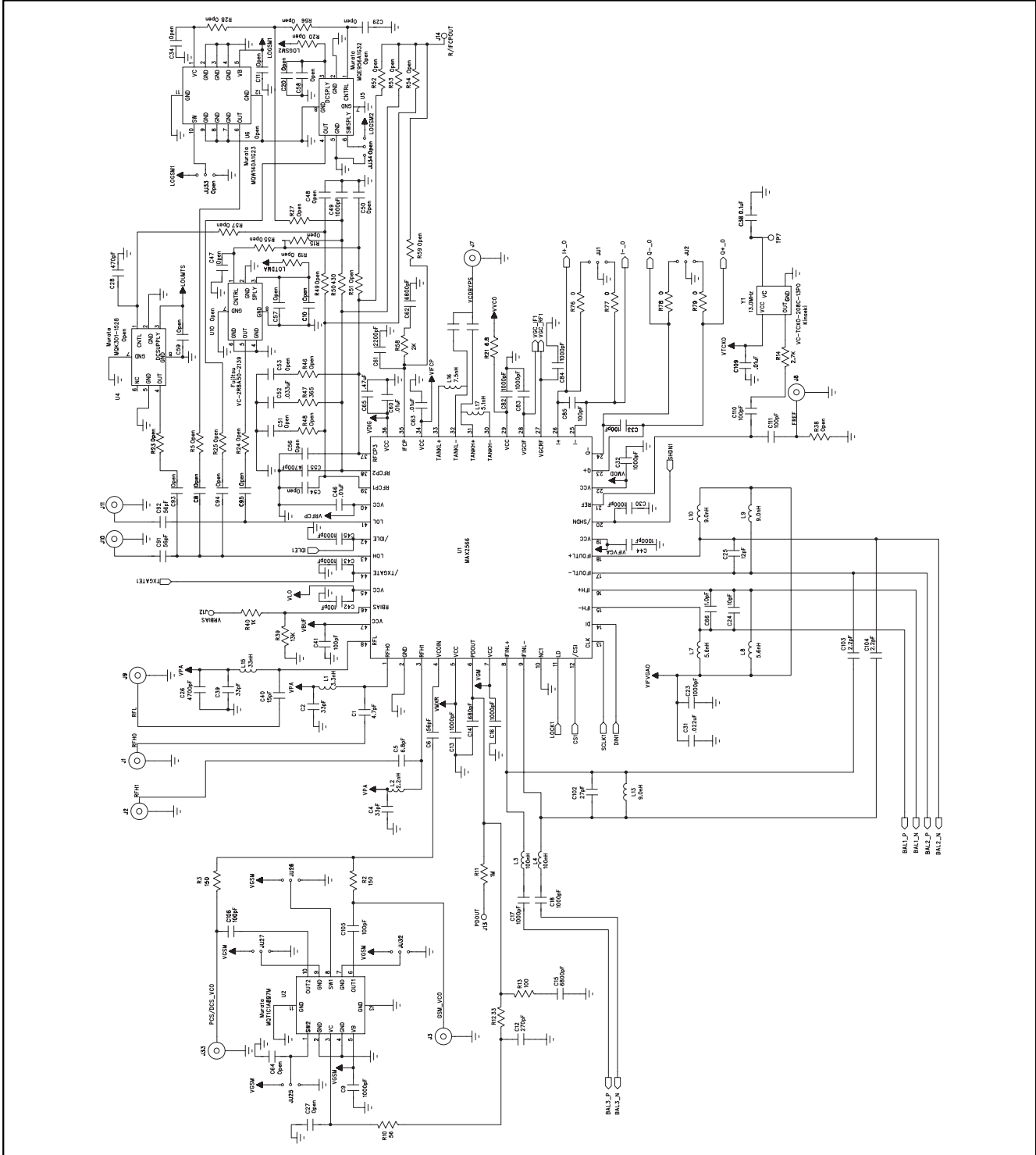

Figure 2. MAX2566 EV Kit Schematic (Sheet 1 of 3)

# MAX2560/MAX2566/MAX2572 Evaluation Kits

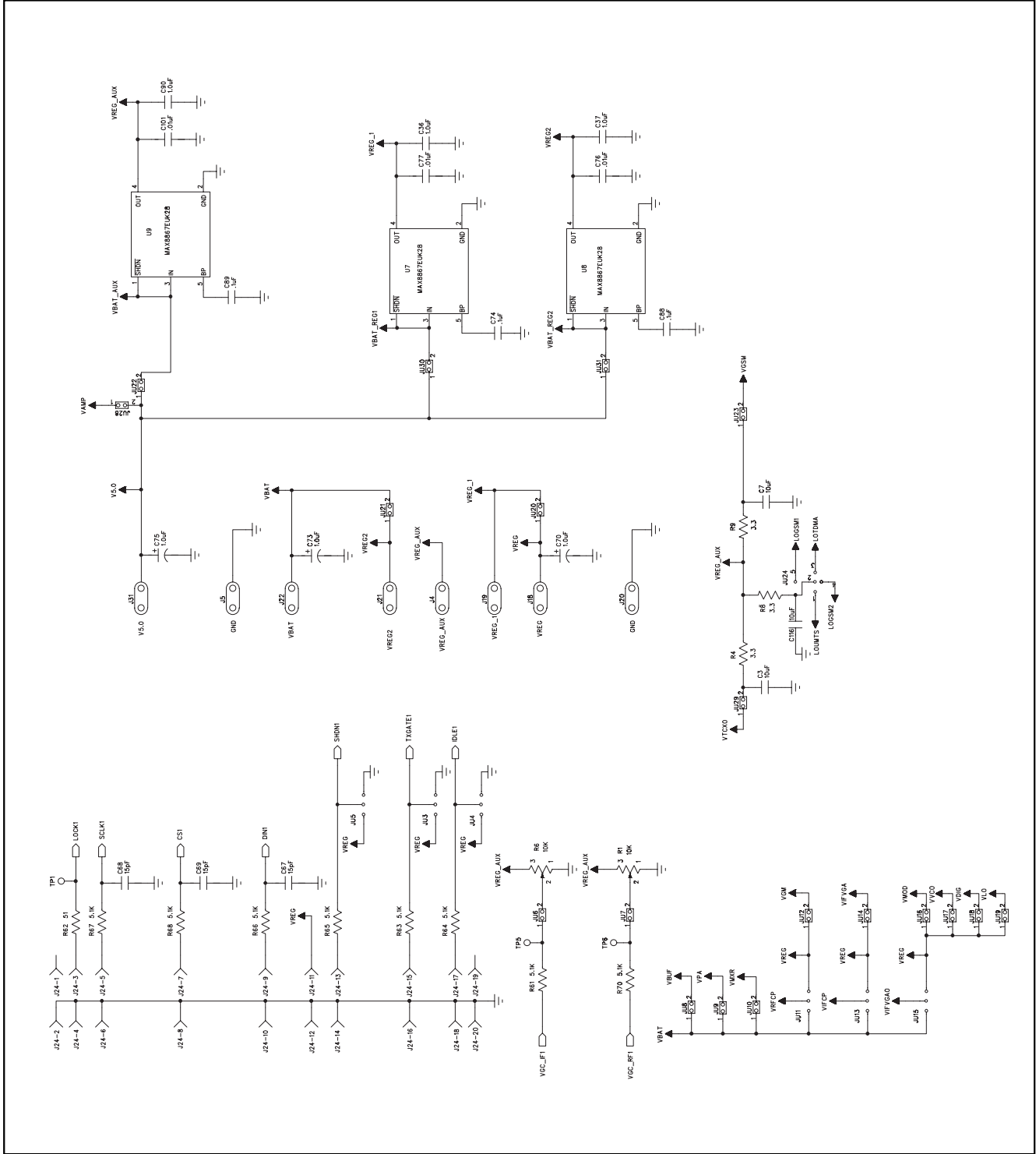

Figure 2. MAX2566 EV Kit Schematic (Sheet 2 of 3)



# MAX2560/MAX2566/MAX2572 Evaluation Kits

Evaluate: MAX2560/MAX2566/MAX2572

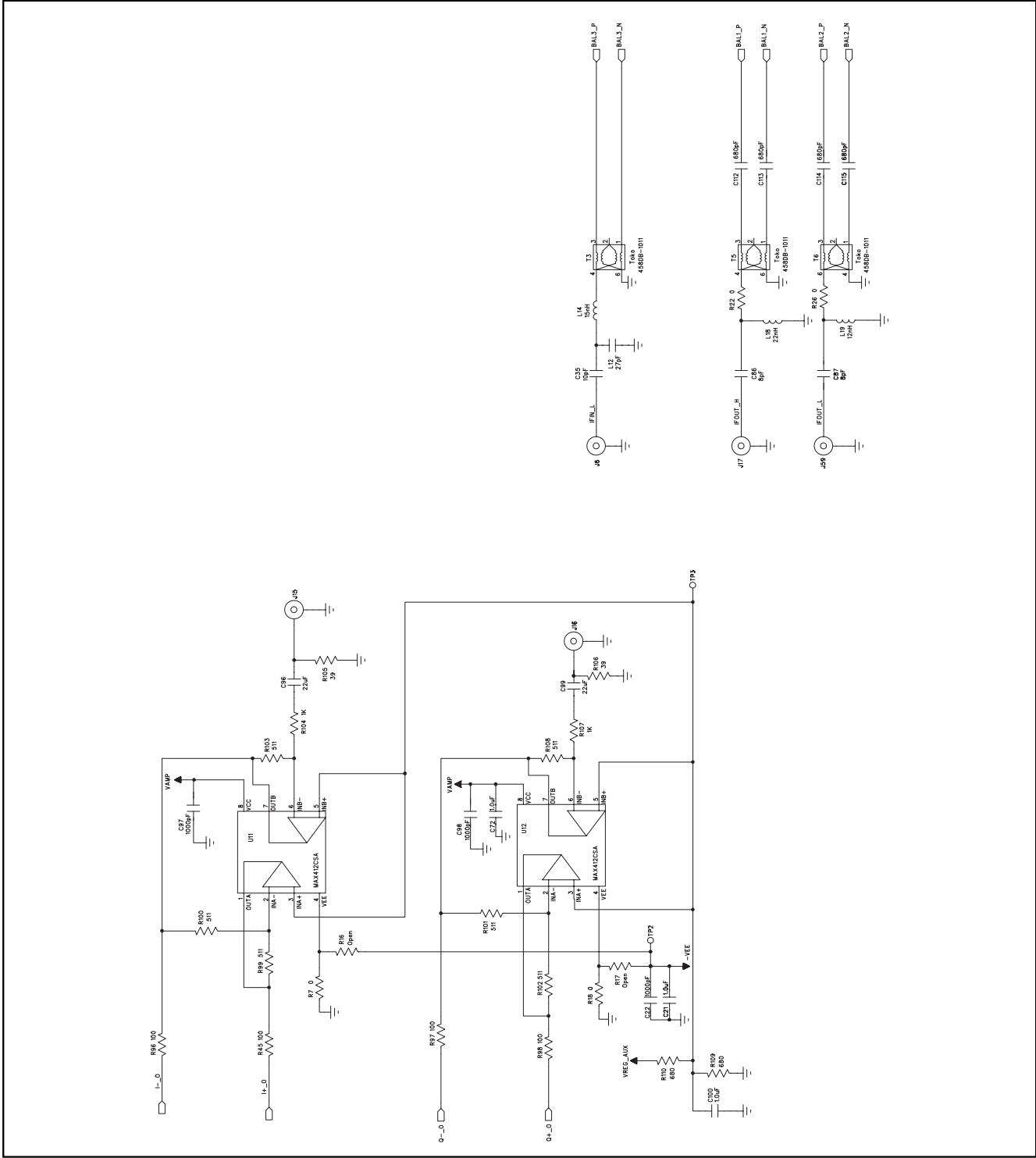

Figure 2. MAX2566 EV Kit Schematic (Sheet 3 of 3)

# MAX2560/MAX2566/MAX2572 Evaluation Kits

## Evaluate: MAX2560/MAX2566/MAX2572

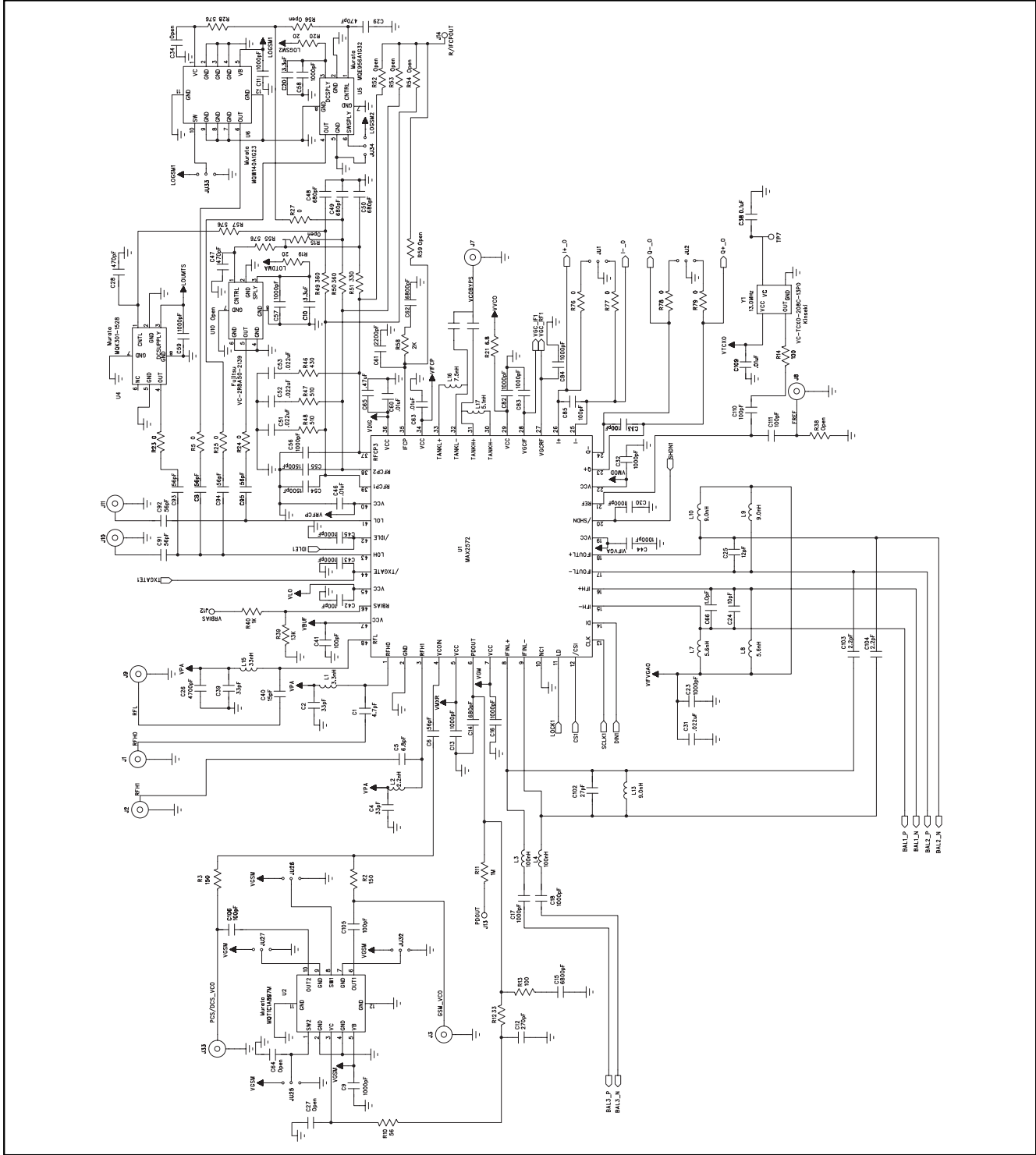

Figure 3. MAX2572 EV Kit Schematic (Sheet 1 of 3)

# MAX2560/MAX2566/MAX2572 Evaluation Kits

Evaluate: MAX2560/MAX2566/MAX2572

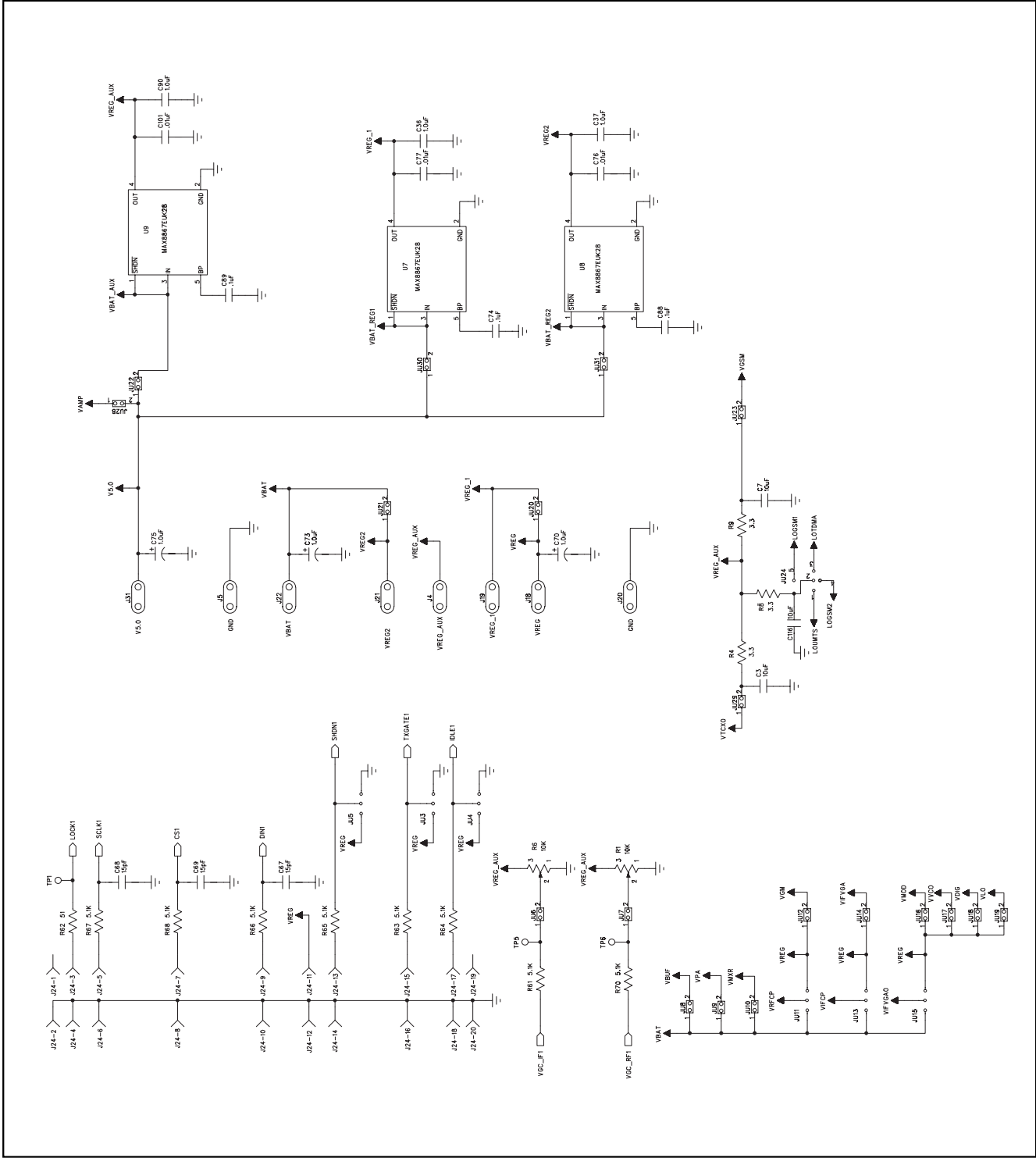

Figure 3. MAX2572 EV Kit Schematic (Sheet 2 of 3)

# MAX2560/MAX2566/MAX2572 Evaluation Kits

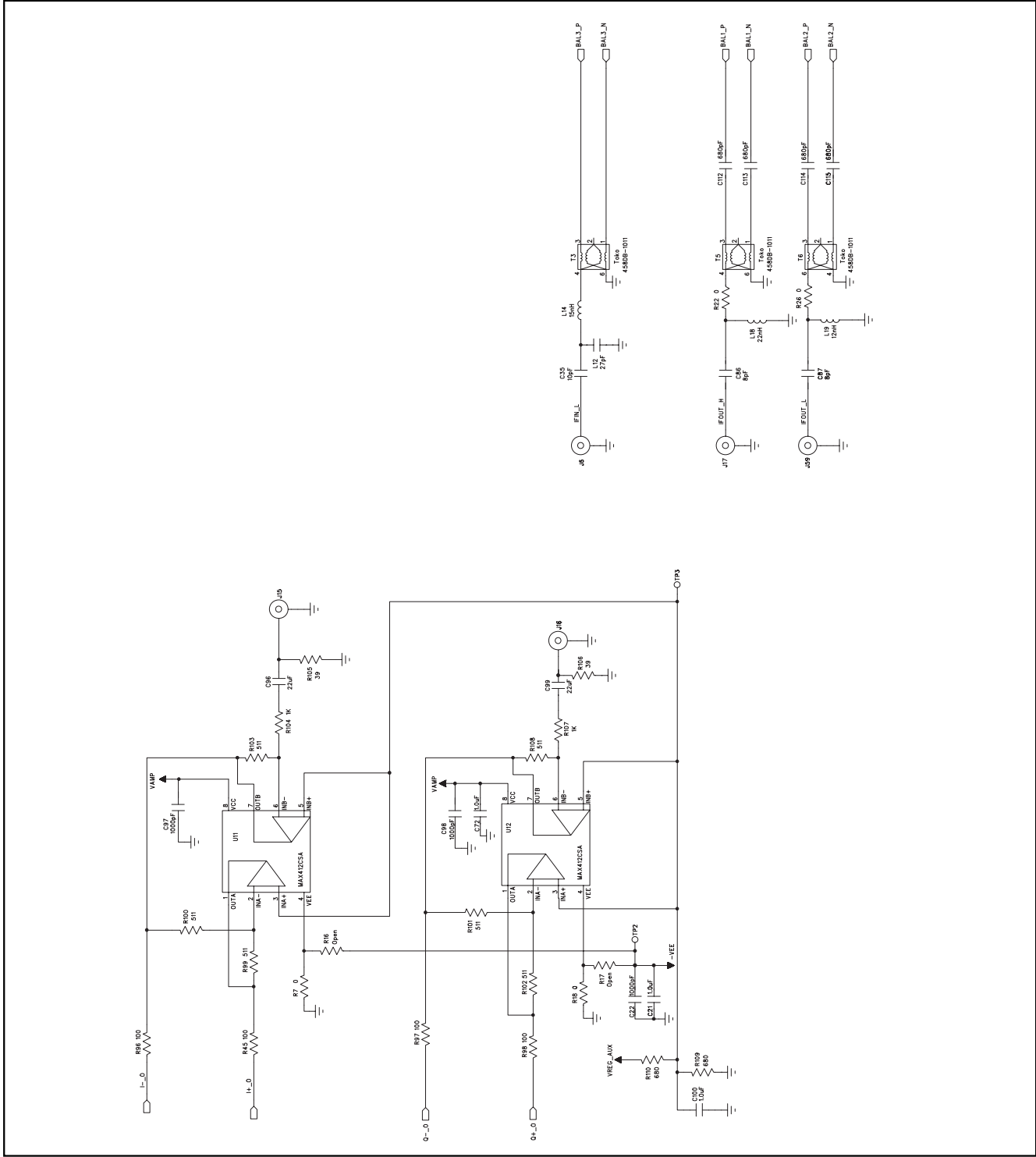

Figure 3. MAX2572 EV Kit Schematic (Sheet 3 of 3)

# MAX2560/MAX2566/MAX2572 Evaluation Kits

Evaluate: MAX2560/MAX2566/MAX2572

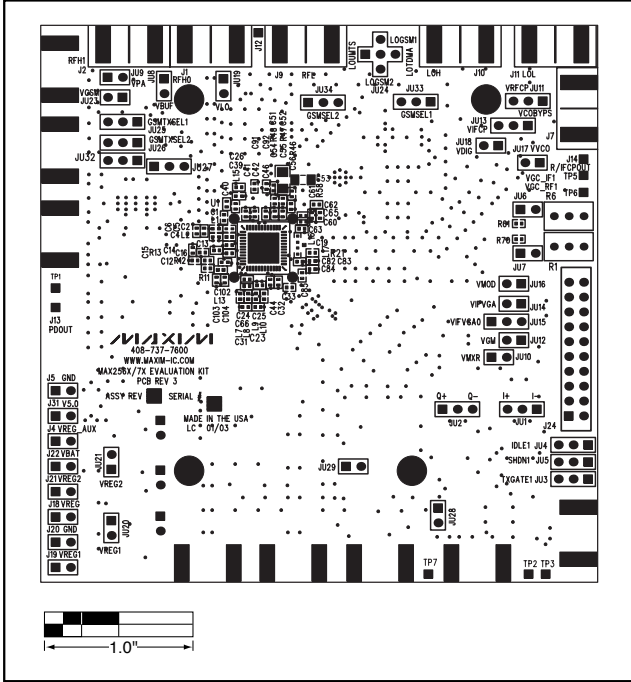

Figure 4. MAX256\_/MAX257\_ EV Kit Component Placement Guide—Component Side

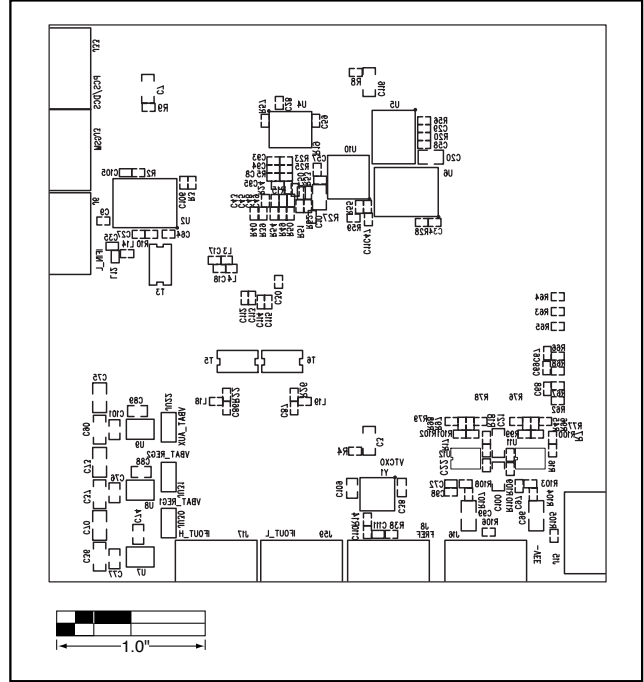

Figure 5. MAX256\_/MAX257\_ EV Kit Component Placement Guide—Solder Side

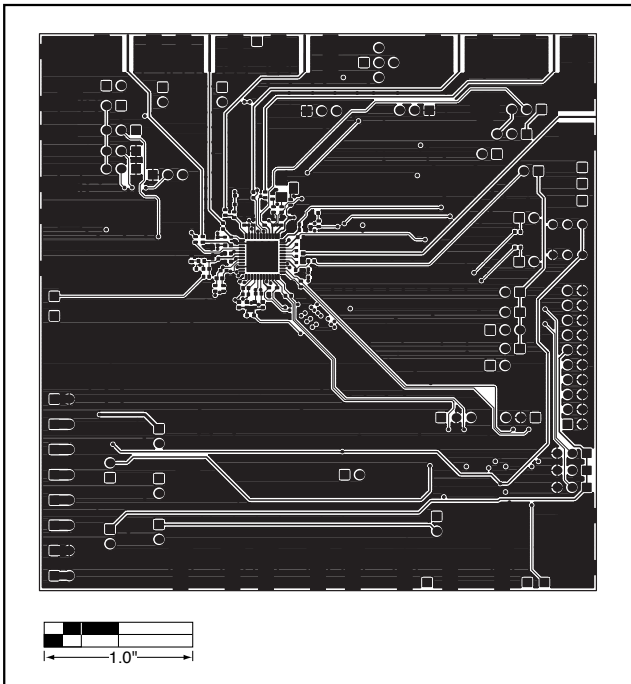

Figure 6. MAX256\_/MAX257\_ EV Kit PC Board Layout—Component Side

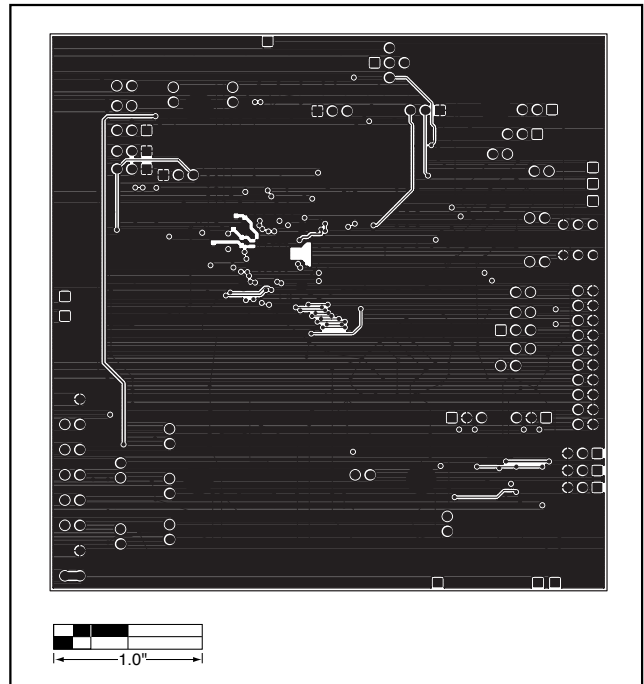

Figure 7. MAX256\_/MAX257\_ EV Kit PC Board Layout—Ground Plane

# MAX2560/MAX2566/MAX2572 Evaluation Kits

**Evaluate: MAX2560/MAX2566/MAX2572**

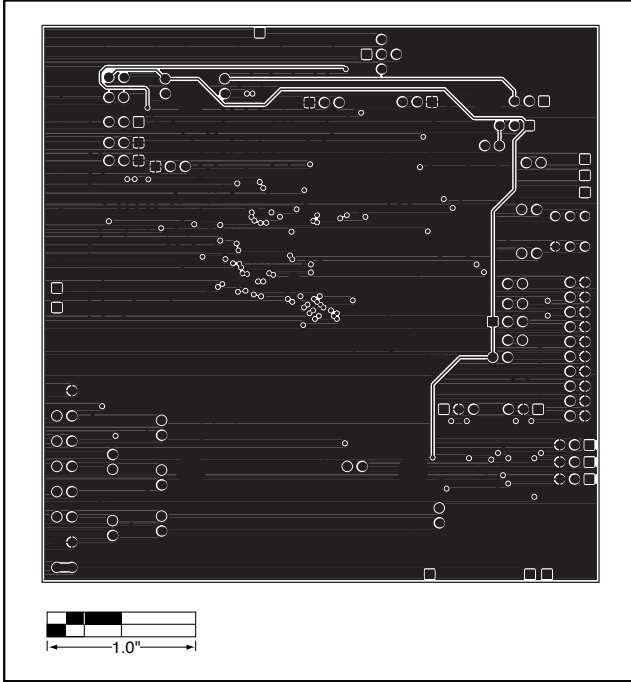

Figure 8. MAX256\_/MAX257\_ EV Kit PC Board Layout—Inner Layer

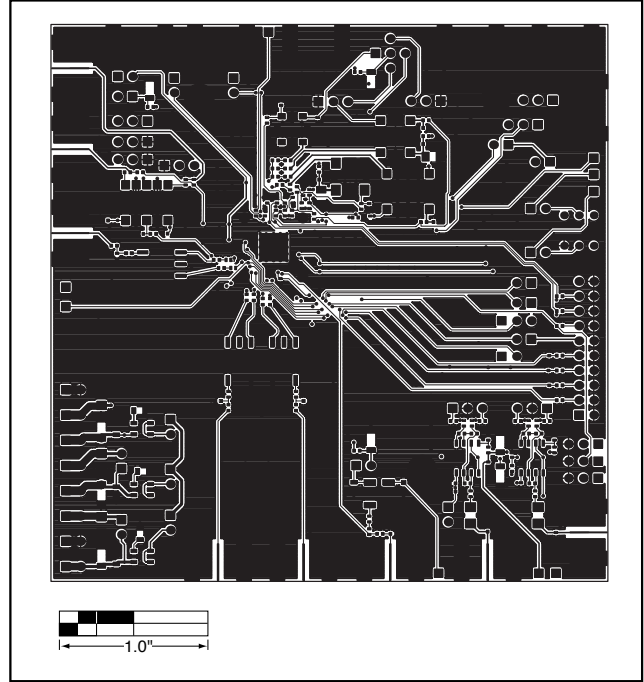

Figure 9. MAX256\_/MAX257\_ EV Kit PC Board Layout—Solder Side

Maxim cannot assume responsibility for use of any circuitry other than circuitry entirely embodied in a Maxim product. No circuit patent licenses are implied. Maxim reserves the right to change the circuitry and specifications without notice at any time.

22 \_\_\_\_\_ **Maxim Integrated Products, 120 San Gabriel Drive, Sunnyvale, CA 94086 408-737-7600**