

# N SERIES

# RF CO-AXIAL CONNECTORS

## Overview

The N series of connectors are medium-sized, weather-resistant constant-impedance coaxial connectors of the screw-coupling type, suited for use with medium-sized coaxial cables. Their rated voltage is 500V (rms). The nominal impedance is 50Ω, and they can be used with frequencies of up to 10GHz. At low frequencies, they can be used with 75Ω cables. They are suited primarily for coaxial cables RG-5, 6, 8, 9/U, etc.

The N series has been approved in Defense Agency specification DSP C 6201.

## Main materials used

| Parts          | Materials           | Finish                             |
|----------------|---------------------|------------------------------------|
| Armor (shell)  | Brass               | Silver plating + surface treatment |
| Outer contacts | Phosphor bronze     | Silver plating + surface treatment |
| Male ends      | Brass               | Silver plating + surface treatment |
| Female ends    | Beryllium copper    | Silver plating + surface treatment |
| Insulation     | Tetrafluoride resin |                                    |
| Packing        | Silicone rubber     |                                    |

## Main performance characteristics

| Items                    | Standard value              |
|--------------------------|-----------------------------|
| Contact resistance       | 3mΩ or less (at 1A DC)      |
| Insulation resistance    | 1000MΩ or more at 500V DC   |
| Withstand voltage        | 1500V AC (rms) for 1 minute |
| Characteristic impedance | 50Ω                         |

## N-P plugs

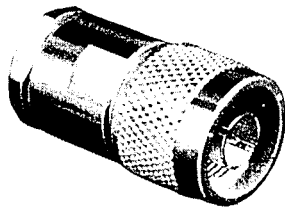

UG-21D/U

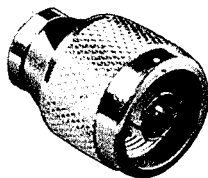

N-P-141

| HRS No.       | Part No.  | Applicable cable | φ D  | φ d  | L    | Remarks   |
|---------------|-----------|------------------|------|------|------|---|
| CL301-0002-7  | UG-18C/U  | RG-5.6.21/U      | 8.7  | 19.0 | 38   |   |
| *CL301-0003-0 | UG-21D/U  | RG-8.9/U         | 11.1 | 19.0 | 38   |   |
| CL301-0022-4  | UG-204C/U | RG-14/U          | 14.1 | 22.2 | 45   |   |
| *CL301-0001-4 | JUG-536/U | RG-58/U          | 5.4  | 19.0 | 38   | For low-voltage use:<br>Withstand voltage: 500V |
| CL301-0078-9  | N-P-3DV   | 3D-2V            | 6.3  | 12.7 | 35   |   |
| *CL301-0120-3 | N-P-5DV   | 5D-2V            | 8.6  | 18.0 | 45.5 |   |
| CL301-0116-6  | N-P-8DV   | 8D-2V            | 12.6 | 23.0 | 51   |   |
| CL301-0199-3  | N-P-5DW   | 5D-2W            | 9.3  | 18   | 46   |   |
| CL301-0205-4  | N-P-5DFB  | 5D-FB            | 8.6  | 18   | 46   |   |
| CL301-0206-7  | N-P-10DFB | 10D-FB           | 14.5 | 23   | 55   |   |

\*Standard product

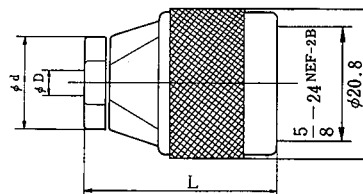
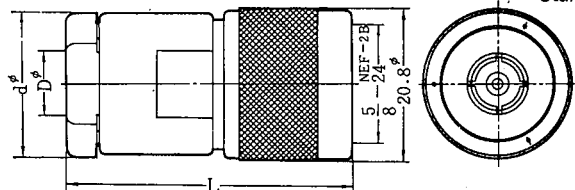

| HRS No.       | Part No. | Applicable cable | φ D  | φ d | L    |
|---------------|----------|------------------|------|-----|------|
| *CL301-0162-3 | N-P-141  | UT-141A          | 3.63 | 13  | 27.3 |

\*Standard product

# N SERIES

# RF CO-AXIAL CONNECTORS

## L-Shaped Plug

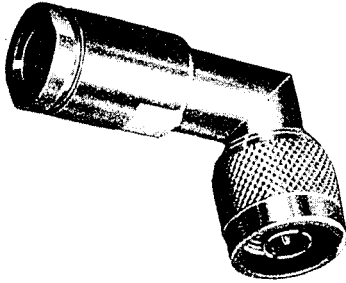

N-LP-5DW

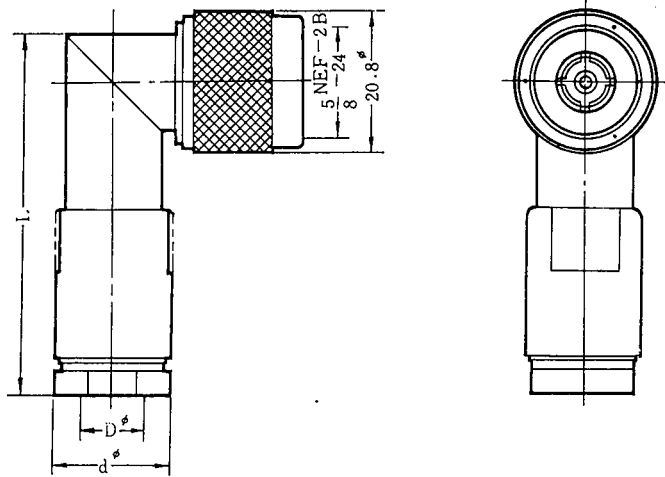

| HRS No.      | Part No. | Applicable cables | $\phi D$ | $\phi d$ | L    | Remarks                                   |
|--------------|----------|-------------------|----------|----------|------|---|
| CL301-0007-0 | N-LP-5DW | 5D-2W             | 9.3      | 17.5     | 52.4 | Nickel-plated except for center conductor |
| CL301-0076-3 | N-LP-58U | RG-58/U           | 5.3      | 15.5     | 44.0 |   |

## Jack

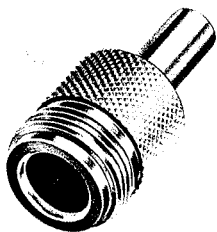

N-J-3DW

| HRS No.      | Part No. | Applicable cable | $\phi A$ |
|--------------|----------|------------------|----------|
| CL301-0179-6 | N-J-3DW  | 3D-XW Irrax      | 4.3      |
| CL301-0180-5 | N-J-3DV  | 3D-2V            | 5.1      |

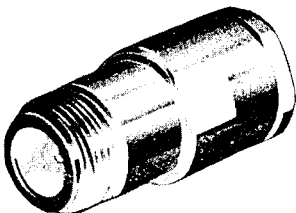
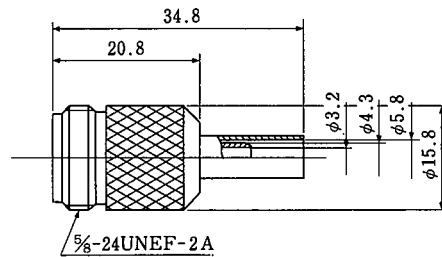

UG-23D/U

| HRS No.      | Part No. | Applicable cable | $\phi D$ | $\phi d$ | L    |
|--------------|----------|------------------|----------|----------|------|
| CL301-0008-3 | UG-23D/U | RG-8,9/U         | 11.1     | 19.0     | 39.7 |

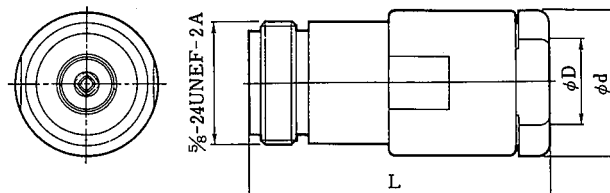

# N SERIES

# RF CO-AXIAL CONNECTORS

## Panel-Jack

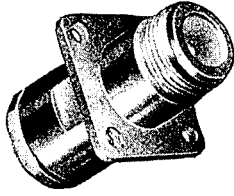

UG-22D/U

| HRS No.       | Part No.  | Applicable cables | $\phi D$ | $\phi d$ | L    | $\square S$ |
|---------------|-----------|-------------------|----------|----------|------|-------------|
| CL301-0010-5  | UG-22D/U  | RG-8,9/U          | 11.1     | 19.0     | 39.7 | 18.24       |
| *CL301-0011-8 | N-PJ-58/U | RG-58/U           | 5.4      | 14.6     | 41.5 | 18.2        |

\*Standard product

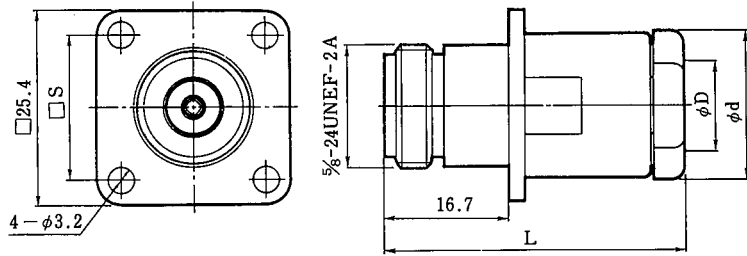

## Receptacle

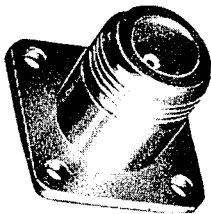

UG-58A/U

| HRS No.       | Part No. |
|---------------|----------|
| *CL301-0012-0 | UG-58A/U |

\*Standard product

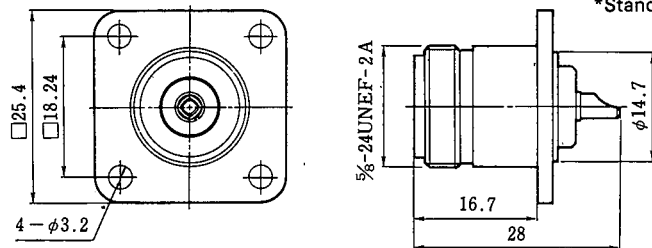

## Adapter

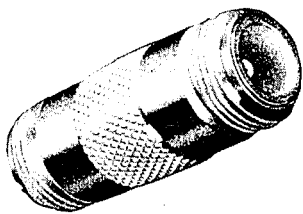

UG-29B/U

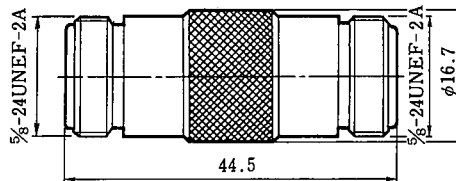

JJ

| HRS No.      | Part No. |
|--------------|----------|
| CL301-0035-6 | UG-29B/U |

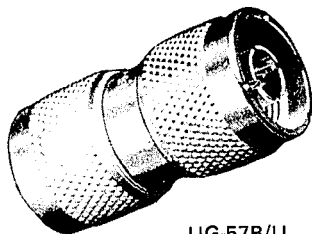

UG-57B/U

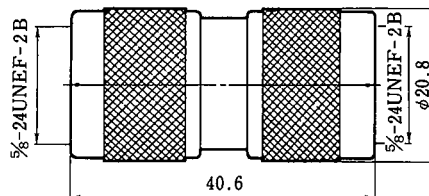

PP

| HRS No.      | Part No. |
|--------------|----------|
| CL301-0018-7 | UG-57B/U |

# N SERIES

# RF CO-AXIAL CONNECTORS

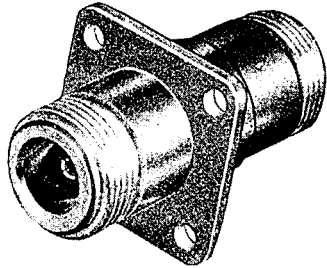

N-PA

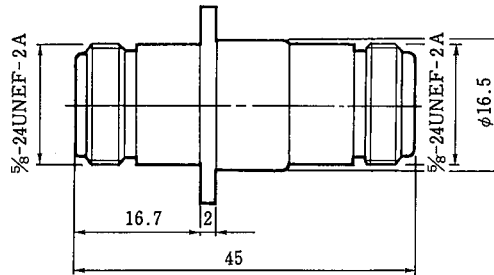

|              |          |
|--------------|----------|
| HRS No.      | Part No. |
| CL301-0036-9 | N-PA     |

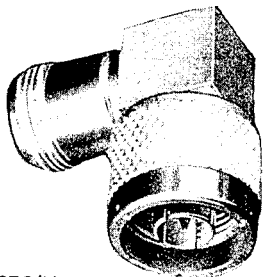
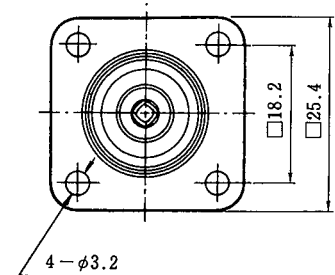

UG-27C/U

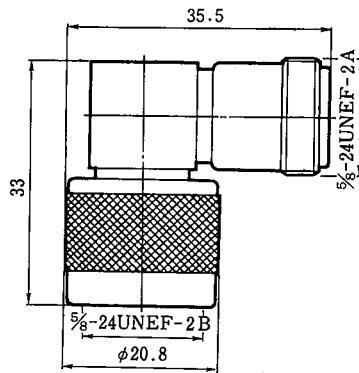

|              |          |
|--------------|----------|
| HRS No.      | Part No. |
| CL301-0015-9 | UG-27C/U |

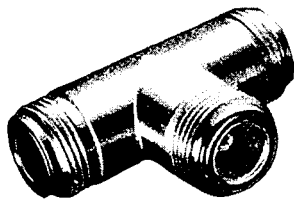

UG-28A/U

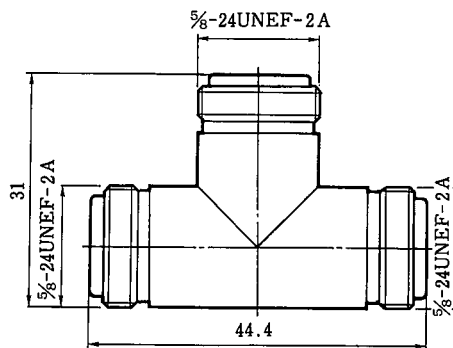

JJJ

|              |          |
|--------------|----------|
| HRS No.      | Part No. |
| CL301-0017-4 | UG-28A/U |

JPJ

|              |           |
|--------------|-----------|
| HRS No.      | Part No.  |
| CL301-0016-1 | UG-107B/U |

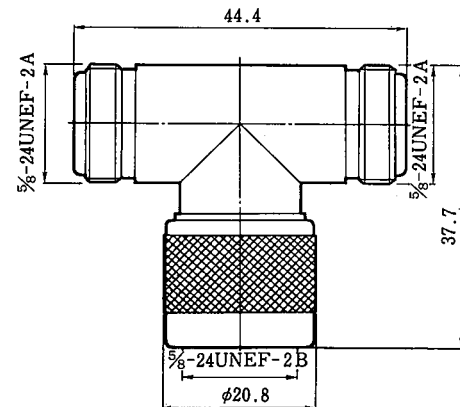

# N SERIES

# RF CO-AXIAL CONNECTORS

## Cap

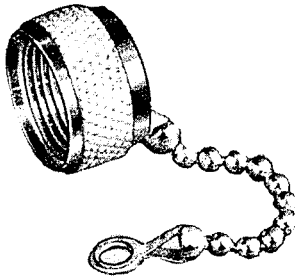

MX-913/U

| HRS No.      | Part No. |
|--------------|----------|
| CL301-0020-9 | MX-913/U |

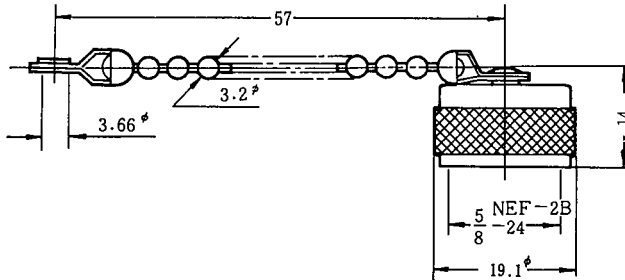

## Functional drawing

Typical product numbers are enclosed in parentheses.

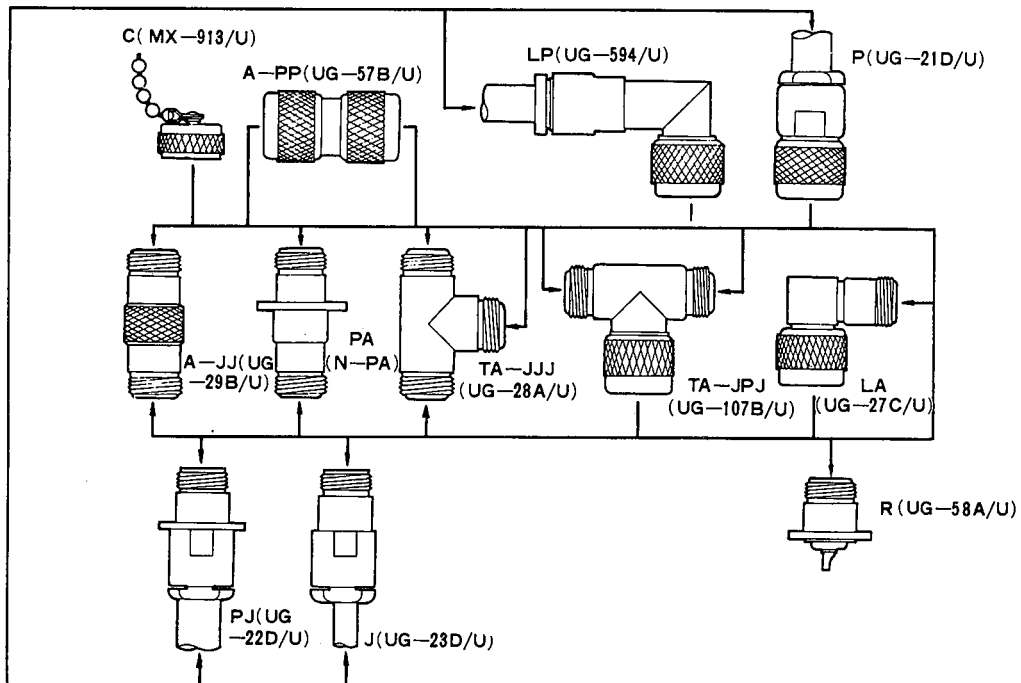

## Connecting methods

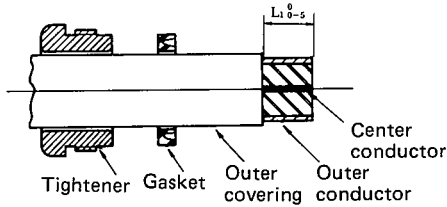

The cable ends are processed as shown in the drawing (refer to Table 1). For the end processing dimensions  $L_1$ , refer to Table 1, End processing dimensions arranged by part number.

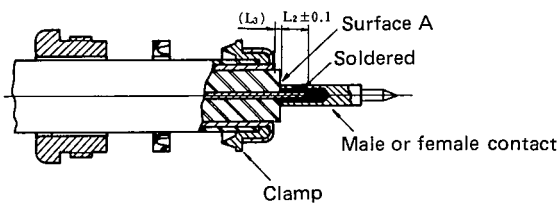

- (1) Insert clamp from tip of cable and fold outer conductor of cable back onto clamp. Using a knife, cut off excess outer conductor left at this time.
- (2) Cut off center conductor of cable at  $L_2$ , from surface A of cable insulation. For end processing dimensions  $L_2$ ,  $L_3$ , refer to Table 1, End processing dimensions arranged by part number. ( $L_3$  is a reference dimension.)  
(Note: Be careful not to damage center conductor.)
- (3) Solder contact and center conductor. It is a good idea at this time to solder the contact preliminarily in advance.  
(Note: There must be no gap between the contact and the cable insulation.)

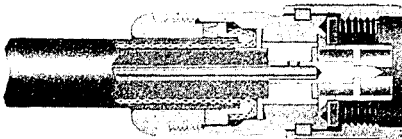

Insert cable and parts into shell and fit sharp end of clamp completely into V-shaped surface of gasket. Tighten tightening nut sufficiently.

■ Remarks

1. The cable end processing dimensions are those of general connectors based on the MIL and DSP standards. They may differ somewhat depending on the type of cable. In such cases, match the dimensions with the connectors.
2. Some clamps and gaskets are not V-shaped, but the connecting procedures are the same.

Table 1 and processing dimensions arranged by part number

Unit: mm

| HRS No.       | Part No.  | $L_1 \pm 0.5$ | $L_2 \pm 0.1$ | $L_3$ |
|---------------|-----------|---------------|---------------|-------|
| *CL301-0001-4 | JUG-536/U | 8.6           | 6             | 1     |
| CL301-0002-7  | UG-18C/U  | 9.6           | 6             | 1     |
| *CL301-0003-0 | UG-21D/U  | 10.0          | 6             | 1     |
| CL301-0007-0  | N-LP-5DW  | 11.5          | 4             | 3.5   |
| CL301-0008-3  | UG-23D/U  | 8.5           | 5             | 1     |
| CL301-0010-5  | UG-22D/U  | 8.5           | 5             | 1     |
| *CL301-0011-8 | N-PJ-58/U | 7.4           | 3             | 3.2   |
| CL301-0022-4  | UG-204C/U | 11.5          | 6             | 2     |
| CL301-0076-3  | N-LP-58U  | 9.2           | 4             | 3.6   |
| CL301-0078-9  | N-P-3DV   | 12.3          | 6             | 4.8   |
| CL301-0116-6  | N-P-8DV   | 12.3          | 5.5           | 3     |
| *CL301-0120-3 | N-P-5DV   | 11.1          | 6             | 1.5   |
| CL301-0199-3  | N-P-5DW   | 12.0          | 6             | 1.5   |
| CL301-0205-4  | N-P-5DFB  | 11.0          | 6             | 5     |
| CL301-0206-7  | N-P-10DFB | 11.0          | 6             | 5     |

\*Standard product