

### General Description

The FS8860 is a low-dropout linear regulator that operates in the input voltage range from +2.5V to +7.0V and delivers 1.0A output current.

The FS8860 is available in two types, fixed output voltage type or adjustable output voltage type. The fixed output voltage type is preset at an internally trimmed voltage 1.8V, 2.5V, or 3.3V. Other options 1.5V, 2.85V, 3.0V and 3.6V are available by special order only. The output voltage range of the adjustable type is from 1.25V to 5V.

The FS8860 consists of a 1.25V bandgap reference, an error amplifier, and a P-channel pass transistor. Other features include short-circuit protection and thermal shutdown protection. The FS8860 devices are available in SOT-223 and TO-252 packages.

### Features

- Low dropout voltage 700mV at 1.0A typ.
- Adjustable output voltage (FS8860-Cx) or fixed output voltage (FS8860-xxCx) preset at 1.8V, 2.5V, or 3.3V
- High output voltage accuracy
- Fixed output voltage :  $\pm 35\text{mV}$
- Adjustable output voltage :  $\pm 50\text{mV}$
- Small output capacitor
- Output current limit
- Thermal overload shutdown protection
- SOT-223 and TO-252 Packages

### Applications

- Active SCSI Terminators
- High Efficiency Linear Regulators
- Monitor Microprocessors
- Low Voltage Micro-Controllers
- Post Regulator for Switching Power

### Ordering Information

FS8860-xx xx

#### Package

Package	Pin 1	Pin 2	Pin 3
G : SOT-223	1.IN	2.GND	3.OUT
H : SOT-223	1.GND	2.IN	3.OUT
J : SOT-223	1.GND	2.OUT	3.IN
P : TO-252	1.IN	2.GND	3.OUT
R : TO-252	1.GND	2.OUT	3.IN

#### Pin Out

Note : For the adjustable voltage types, the GND pin is replaced with the ADJ pin

#### Temperature Range

C : Commercial Standard  
P : Commercial Standard, Lead(Pb) Free and Phosphorous(P) Free Package

#### Output Voltage

(For fixed voltage types only. For adjustable voltage types, these two digits are eliminated.)

15 : 1.5V	18 : 1.8V	25 : 2.5V
29 : 2.85V	30 : 3.0V	33 : 3.3V
36 : 3.6V		

Default : Adjustable Output

Note: The output voltages other than the preset values are available by order only.

### Pin Configurations

Part No.	Pin 1	Pin 2	Pin 3
FS8860-xxxG	IN	GND/ADJ (TAP)	OUT
FS8860-xxxH	GND/ADJ	IN (TAP)	OUT
FS8860-xxxJ	GND/ADJ	OUT (TAP)	IN

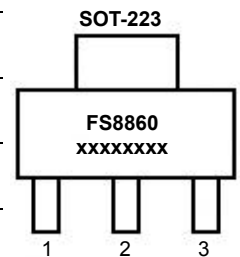

Part No.	Pin 1	Pin 2	Pin 3
FS8860-xxxP	IN	GND/ADJ (TAP)	OUT
FS8860-xxxR	GND/ADJ	OUT (TAP)	IN

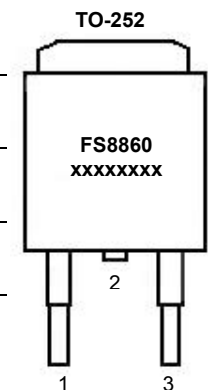

### Package Marking Information

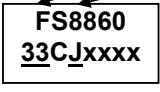
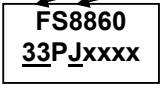
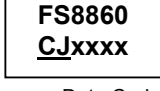
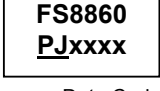
<p>EX : FS8860-33CJ</p>  <p>xxxx : Date Code</p>	<p>EX : FS8860-33PJ</p>  <p>xxxx : Date Code</p>
<p>EX : FS8860-CJ (ADJ type)</p>  <p>xxxx : Date Code</p>	<p>EX : FS8860-PJ (ADJ type)</p>  <p>xxxx : Date Code</p>

### Pin Description

Part NO.	Symbol	Description
FS8860-xxCG FS8860-xxCH FS8860-xxCJ FS8860-xxCP FS8860-xxCR	GND/ADJ	Ground pin or adjust terminal pin.
	IN	Regulator input pin.
	OUT	Regulator output pin.

**IN** is the regulator input pin. Supply voltage can range from 2.5V to 7.0V. Bypass with a 10μF capacitor to GND.

**OUT** is the output voltage pin. Sources up to 1.0A. Bypass with a 10μF capacitor to GND.

**GND** provides the reference for all voltages.

**ADJ** provides  $V_{REF}=1.25V$  (Typ.) for adjustable output voltage.

### Typical Application Circuit

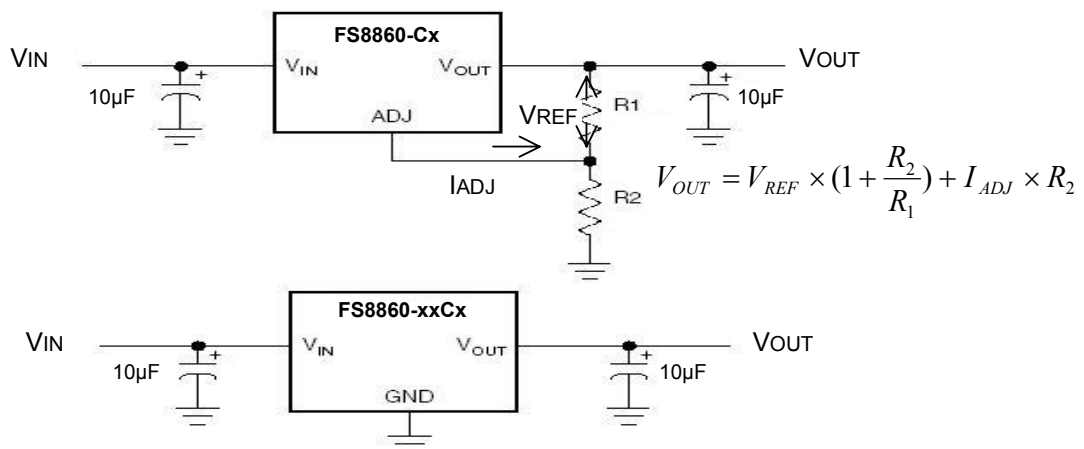

**Functional Block Diagrams**

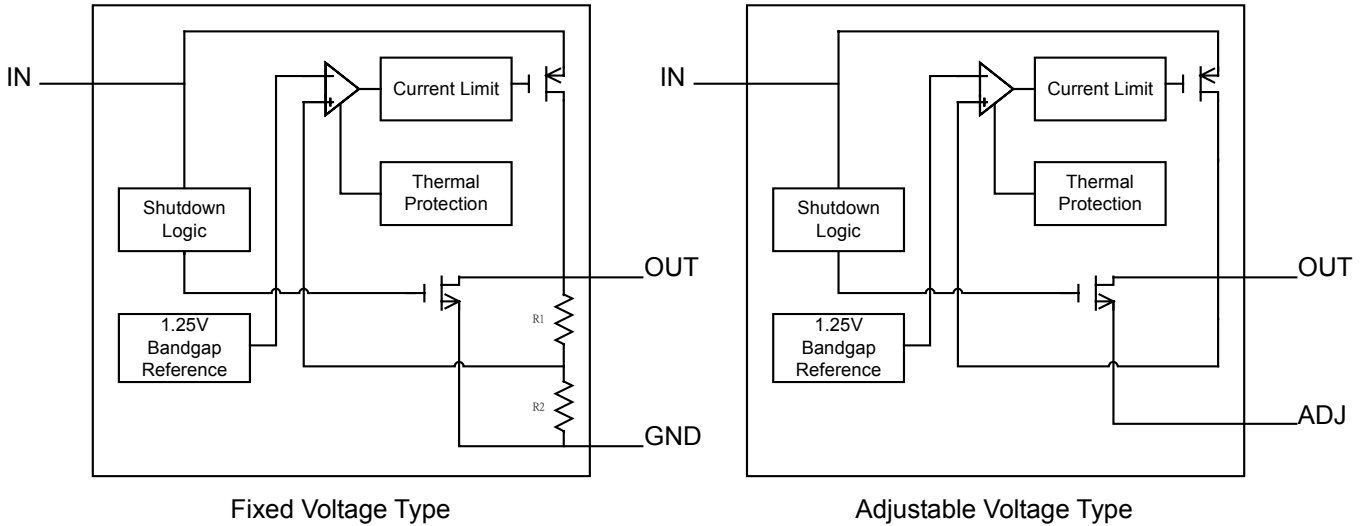

**Absolute Maximum Ratings**

Input voltage $V_{IN}$ to GND	-----	9V
Output current limit, $I_{LIMIT}$	-----	1.3A
Continuous power dissipation	-----	Internally Limited
Junction Temperature, $T_J$	-----	+155°C
Storage temperature range, $T_{STG}$	-----	-55°C to +150°C
Operating junction temperature range	-----	-40°C to +125°C
Lead temperature (soldering, 10sec)	-----	260°C

\* Stresses beyond those listed under "absolute maximum ratings" may cause permanent damage to the device. These are stress ratings only, and function operation of the device at these or any other conditions beyond those indicated under "recommended operating conditions" is not implied. Exposure to absolute-maximum-rated conditions for extended periods may affect device reliability.

### Electrical Characteristics

(C<sub>IN</sub>=10μF, C<sub>OUT</sub>=10μF, T<sub>A</sub>=25°C, unless otherwise noted.)

Symbol	Parameter	Test Conditions	Min	Typ	Max	Unit
V <sub>IN</sub>	Input Voltage		2.5		7.0	V
V <sub>OUT</sub>	Output Voltage	Fixed Voltage Type V <sub>IN</sub> =V <sub>OUT</sub> +1.0V, I <sub>OUT</sub> =1mA	V <sub>OUT</sub> -0.035	V <sub>OUT</sub>	V <sub>OUT</sub> +0.035	V
		Adjustable Voltage Type V <sub>IN</sub> =V <sub>OUT</sub> +1.2V, I <sub>OUT</sub> =1mA	1.20	1.25	1.30	V
ΔV <sub>OUT</sub>	Output Voltage Accuracy	V <sub>IN</sub> >V <sub>OUT</sub> +1.0V, V <sub>IN</sub> ≤7V (Fixed Voltage Type)	-35		+35	mV
		V <sub>IN</sub> >V <sub>OUT</sub> +1.2V, V <sub>IN</sub> ≤7V (Adjustable Voltage Type)	-50		+50	mV
I <sub>MAX</sub>	Maximum Output Current		1.0			A
I <sub>LIMIT</sub>	Current Limit				1.3	A
I <sub>SC</sub>	Short-Circuit Current	V <sub>OUT</sub> =0V	V <sub>IN</sub> >V <sub>OUT</sub> +1.0V (Fixed Voltage Type)	650	760	mA
			V <sub>IN</sub> >V <sub>OUT</sub> +1.2V (Adjustable Voltage Type)			
I <sub>Q</sub>	Ground Pin Current	I <sub>LOAD</sub> =0mA to 1A, V <sub>IN</sub> =V <sub>OUT</sub> +1.0V		65	90	μA
I <sub>ADJ</sub>	ADJ Pin Current	I <sub>LOAD</sub> =0mA to 1A, V <sub>IN</sub> =V <sub>OUT</sub> +1.2V		65	90	μA
V <sub>DROP</sub>	Dropout Voltage (Fixed Output Voltage Version)	I <sub>OUT</sub> =100mA		60	100	mV
		I <sub>OUT</sub> =500mA		300	500	mV
		I <sub>OUT</sub> =1.0A		700	1000	mV
ΔV <sub>LINE</sub>	Line Regulation	V <sub>OUT</sub> +1.0V<V <sub>IN</sub> <7V, I <sub>LOAD</sub> =1mA (Fixed Voltage Type)		0.2	0.3	%/V
		V <sub>OUT</sub> +1.2V<V <sub>IN</sub> <7V, I <sub>LOAD</sub> =1mA (Adjustable Voltage Type)		0.2	0.3	%/V
ΔV <sub>LOAD</sub>	Load Regulation	I <sub>OUT</sub> =0mA to 1.0A (Fixed Voltage Type)		0.02	0.03	%/mA
		I <sub>OUT</sub> =0mA to 1.0A (Adjustable Voltage Type)		0.1	0.15	%/mA
e <sub>N</sub>	Output Noise	F=1Hz to 10KHz, C <sub>OUT</sub> =10μF		80		μVRMS
PSRR	Ripple Rejection	F=10KHz, C <sub>OUT</sub> =10μF		75		dB
T <sub>SD</sub>	Thermal Shutdown Temperature			155		°C
T <sub>HYS</sub>	Thermal Shutdown Hysteresis			20		°C
θ <sub>JA</sub>	Thermal Resistance ( No heat-sink, No air flow)	SOT-223		155		°C/W
		TO-252		90		°C/W

### Typical Operating Characteristics

(C<sub>IN</sub>=10μF, C<sub>OUT</sub>=10μF, T<sub>A</sub>=+25°C, unless otherwise noted.)

**OUTPUT VOLTAGE vs. INPUT VOLTAGE**

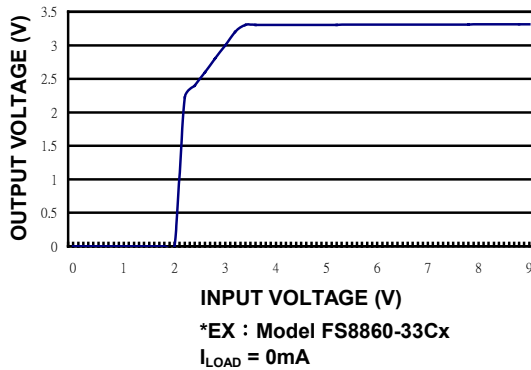

**GROUND PIN CURRENT vs. AMBIENT TEMPERATURE**

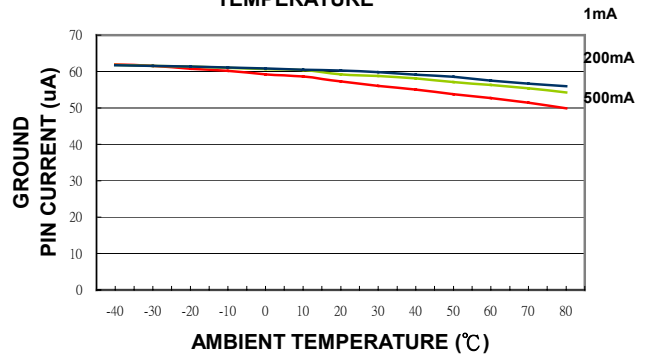

**DROPOUT VOLTAGE vs. LOAD CURRENT**

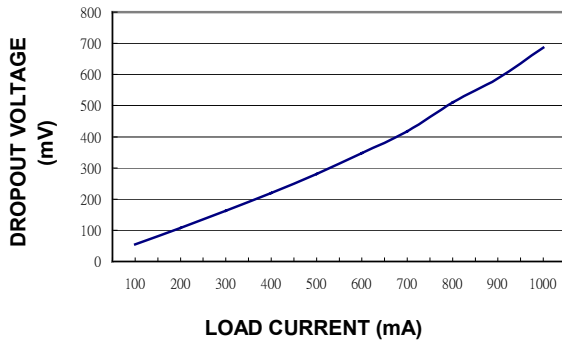

**R<sub>on</sub> vs. LOAD CURRENT**

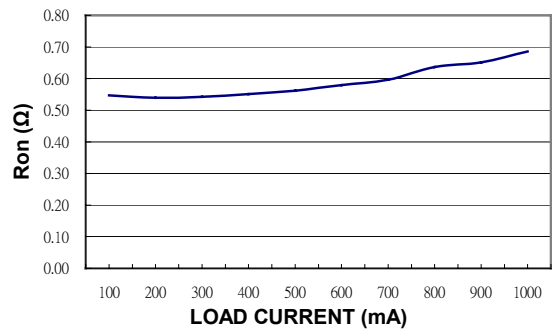

**POWER SUPPLY REJECTION RATIO vs. FREQUENCY**

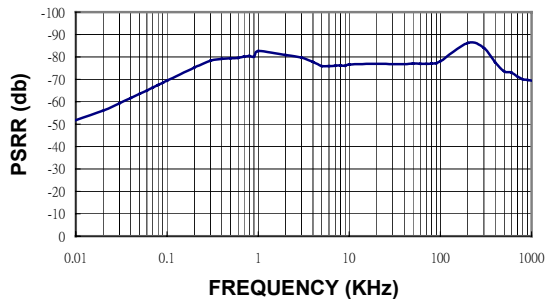

**GROUND PIN CURRENT vs. LOAD CURRENT**

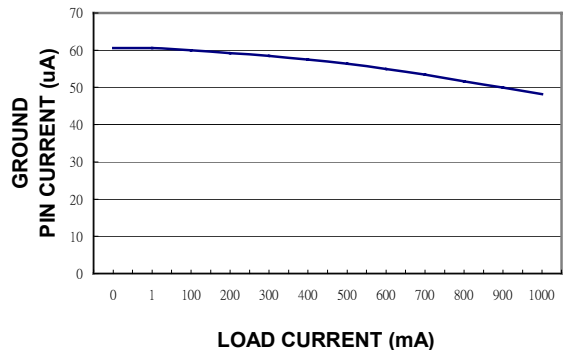

**OUTPUT VOLTAGE vs. AMBIENT TEMPERATURE**

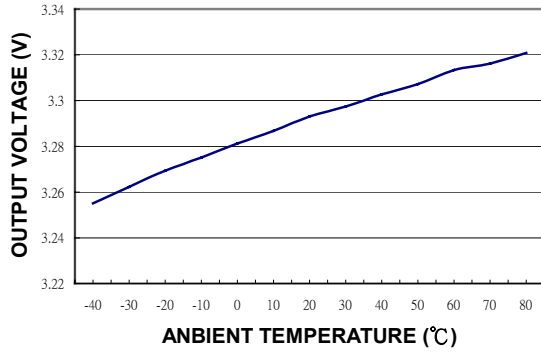

**ADJ PIN CURRENT vs. INPUT VOLTAGE**

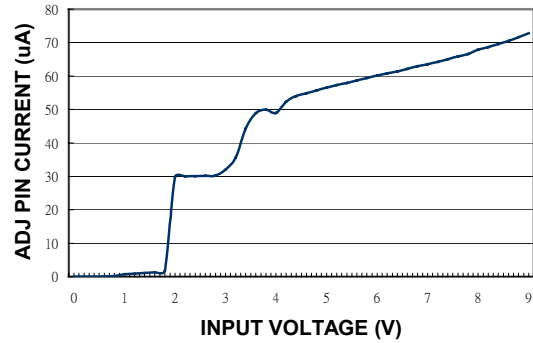

**ADJ PIN CURRENT vs. LOAD CURRENT**

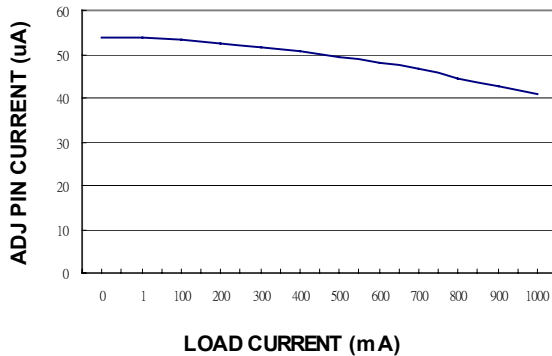

**ADJ PIN CURRENT vs. AMBIENT TEMPERATURE**

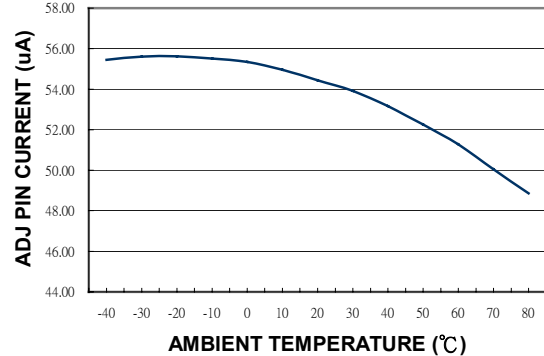

**Vref vs. AMBIENT TEMPERATURE**

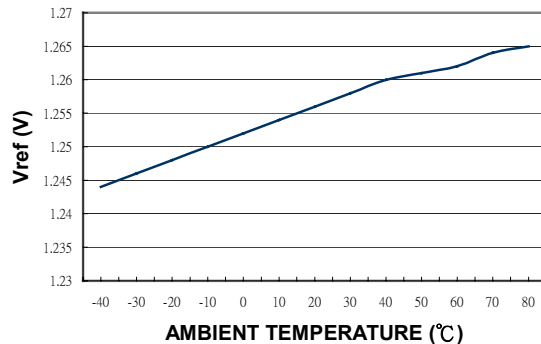

**Output Noise DC to 1MHz**

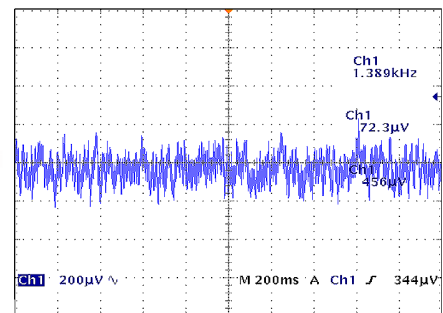

I<sub>Load</sub>=0

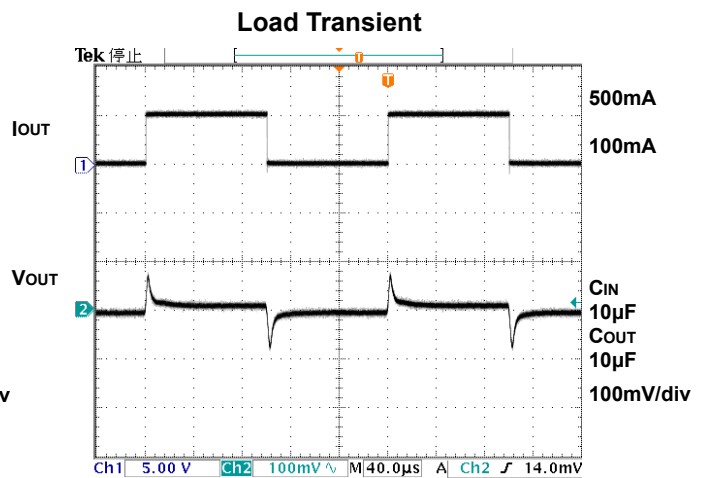
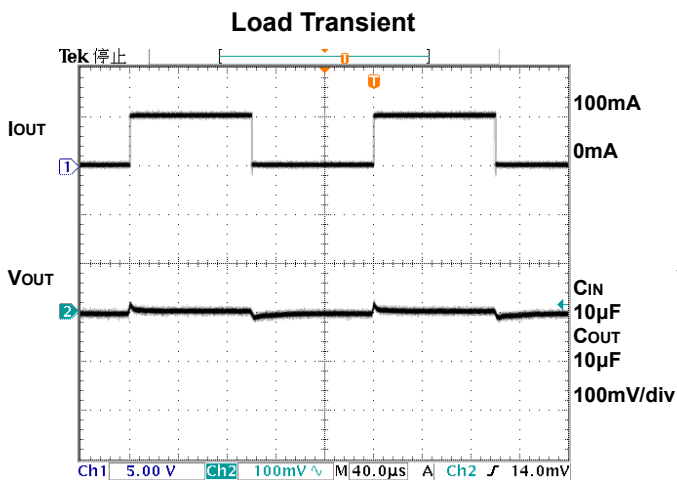
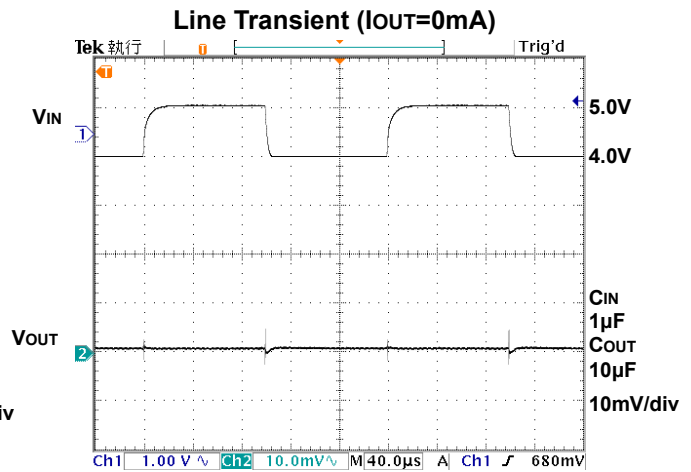
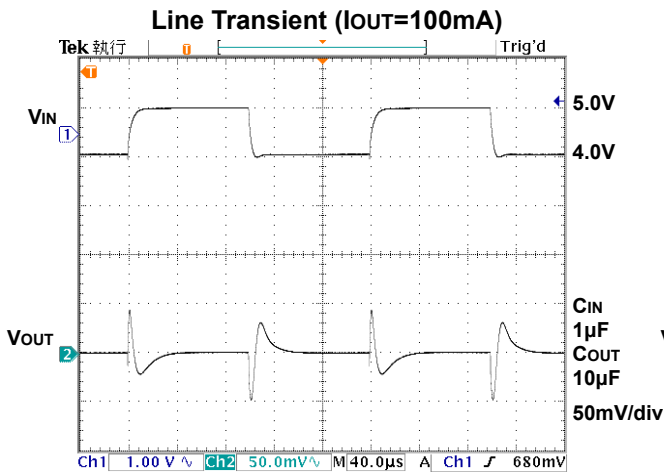
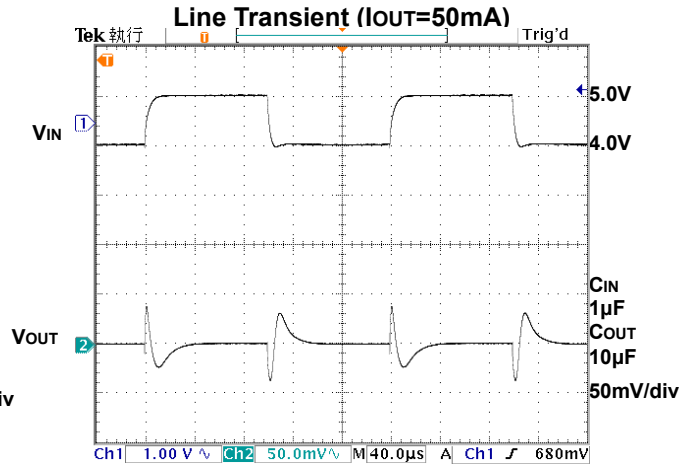
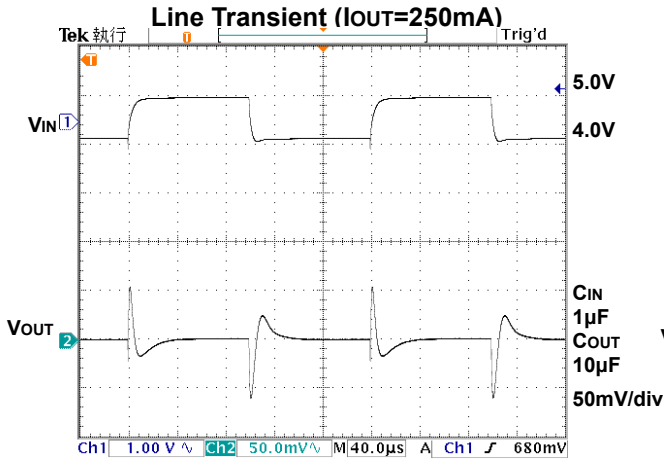

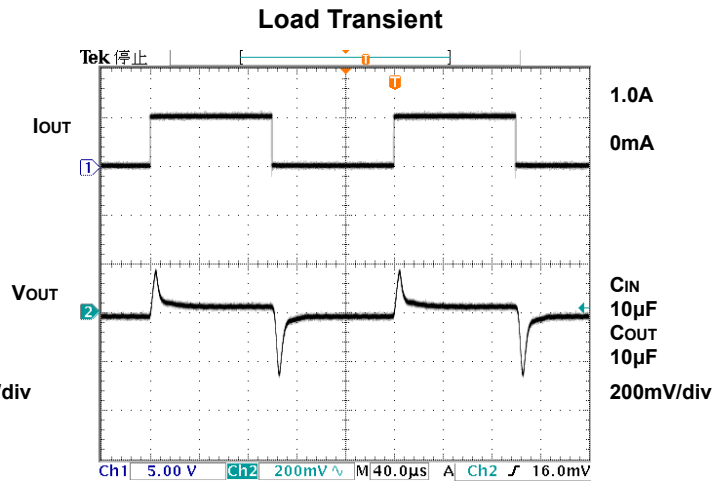
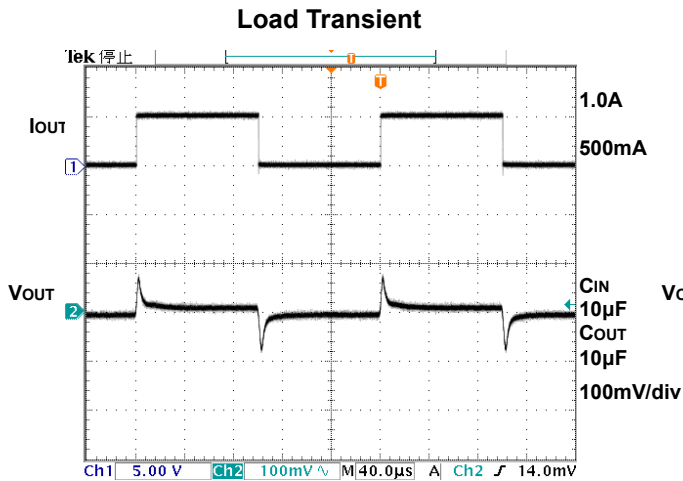

## Detail Description

The FS8860 is a low-dropout linear regulator. The device provides preset 1.8V, 2.5V and 3.3V output voltages for output current up to 1.0A. Adjustable output voltage and other mask options for special output voltages are also available. As illustrated in function block diagram, it consists of a 1.25V bandgap reference, an error amplifier, a P-channel pass transistor and an internal feedback voltage divider (fixed voltage types).

The 1.25V bandgap reference is connected to the error amplifier, which compares this reference with the feedback voltage and amplifies the voltage difference. If the feedback voltage is lower than the reference voltage, the pass-transistor gate is pulled lower, which allows more current to pass to the output pin and increases the output voltage. If the feedback voltage is too high, the pass-transistor gate is pulled up to decrease the output voltage.

The output voltage is feed back through an internal resistive divider (or external resistive divider for adjustable output voltage type) connected to OUT pin. Additional blocks include an output current limiter, thermal sensor, and shutdown logic.

### Internal P-channel Pass Transistor

The FS8860 features a P-channel MOSFET pass transistor. Unlike similar designs using PNP pass transistors, P-channel MOSFETs require no base drive, which reduces ground pin current.

PNP-based regulators also waste considerable current in dropout when the pass transistor saturates, and use high base-drive currents under large loads. The FS8860 does not suffer from these problems and consumes only 65µA (Typ.) of ground pin current under heavy loads as well as in dropout conditions.

### Output Voltage Selection

For fixed voltage type of FS8860, the output voltage is preset at an internally trimmed voltage. The first two digits of part number suffix identify the output voltage (see **Ordering Information**). For example, the FS8860-33CJ has a preset 3.3V output voltage.

For adjustable voltage type of FS8860, the output voltage is set by comparing the feedback voltage at adjust terminal to the internal bandgap reference voltage. The reference voltage  $V_{REF}$  is 1.25V. The output voltage is given by the equation:

$$V_{OUT} = V_{REF} * (1 + R2/R1) + I_{ADJ} * R2$$

(see **Typical Application Schematic**)

### Current Limit

The FS8860 also includes a fold back current limiter. It monitors and controls the pass transistor's gate voltage, estimates the output current, and limits the output current within 1.3A.



### Thermal Overload Protection

Thermal overload protection limits total power dissipation in the FS8860. When the junction temperature exceeds  $T_J = +155^{\circ}\text{C}$ , a thermal sensor turns off the pass transistor, allowing the IC to cool down. The thermal sensor turns the pass transistor on again after the junction temperature cools down by  $20^{\circ}\text{C}$ , resulting in a pulsed output during continuous thermal overload conditions.

Thermal overload protection is designed to protect the FS8860 in the event of fault conditions. For continuous operation, the maximum operating junction temperature rating of  $T_J = +125^{\circ}\text{C}$  should not be exceeded.

### Operating Region and Power Dissipation

Maximum power dissipation of the FS8860 depends on the thermal resistance of the case and circuit board, the temperature difference between the die junction and ambient air, and the rate of airflow. The power dissipation across the devices is  $P = I_{\text{OUT}} \times (V_{\text{IN}} - V_{\text{OUT}})$ . The resulting maximum power dissipation is:

$$P_{\text{MAX}} = \frac{(T_J - T_A)}{\theta_{\text{JC}} + \theta_{\text{CA}}} = \frac{(T_J - T_A)}{\theta_{\text{JA}}}$$

Where  $(T_J - T_A)$  is the temperature difference between the FS8860 die junction and the surrounding air,  $\theta_{\text{JC}}$  is the thermal resistance of the package chosen, and  $\theta_{\text{CA}}$  is the thermal resistance through the printed circuit board, copper traces

and other materials to the surrounding air. For better heat-sinking, the copper area should be equally shared between the IN, OUT, and GND pins.

If the FS8860 uses a SOT-223 package and this package is mounted on a double sided printed circuit board with two square inches of copper allocated for "heat spreading", the resulting  $\theta_{\text{JA}}$  is  $80^{\circ}\text{C/W}$ .

Based on the maximum operating junction temperature  $125^{\circ}\text{C}$  with an ambient of  $25^{\circ}\text{C}$ , the maximum power dissipation will be:

$$P_{\text{MAX}} = \frac{(T_J - T_A)}{\theta_{\text{JC}} + \theta_{\text{CA}}} = \frac{(125 - 25)}{80} = 1.25\text{W}$$

Thermal characteristics were measured using a double-sided board with  $1'' \times 2''$  square inches of copper area connected to the GND pin for "heat spreading".

### Input-Output Voltage

A regulator's minimum input-output voltage differential, or dropout voltage, determines the lowest usable supply voltage. In battery-powered systems, this will determine the useful end-of-life battery voltage. The FS8860 uses a P-channel MOSFET pass transistor, its dropout voltage is a function of drain-to-source on-resistance ( $R_{\text{DS(ON)}}$ ) multiplied by the output current.

$$V_{\text{DROPOUT}} = V_{\text{IN}} - V_{\text{OUT}} = R_{\text{DS(ON)}} \times I_{\text{OUT}}$$

**Package Outline**

**SOT-223**

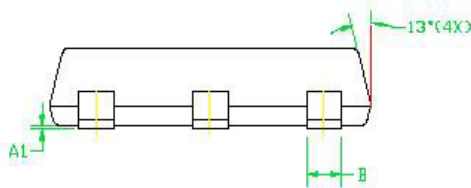
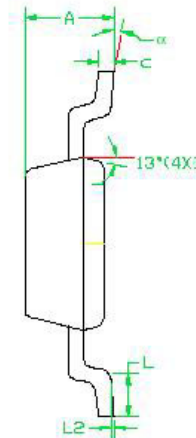
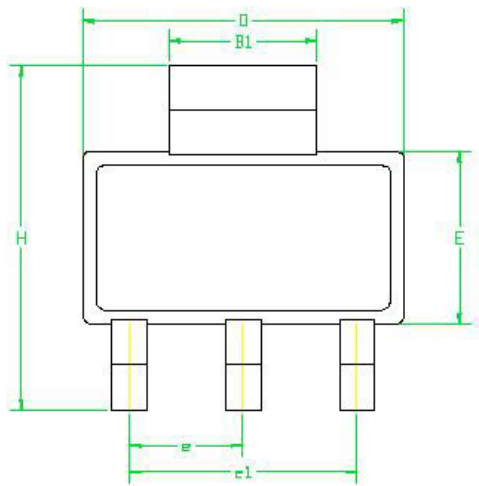

SYMBOLS	MILLIMETERS		INCHES	
	MIN	MAX	MIN	MAX
A	1.55	1.90	0.061	0.071
A1	0.02	0.12	0.0008	0.0047
B	0.60	0.80	0.024	0.031
B1	2.90	3.10	0.114	0.122
c	0.24	0.32	0.009	0.013
D	6.30	6.70	0.248	0.264
E	3.30	3.70	0.130	0.146
e	2.30 BSC		0.090 BSC	
e1	4.60 BSC		0.181 BSC	
H	6.70	7.30	0.264	0.287
L	0.90 MIN		0.036 MIN	
L2	0.06 BSC		0.0024 BSC	
α	0°	10°	0°	10°

**TO-252**

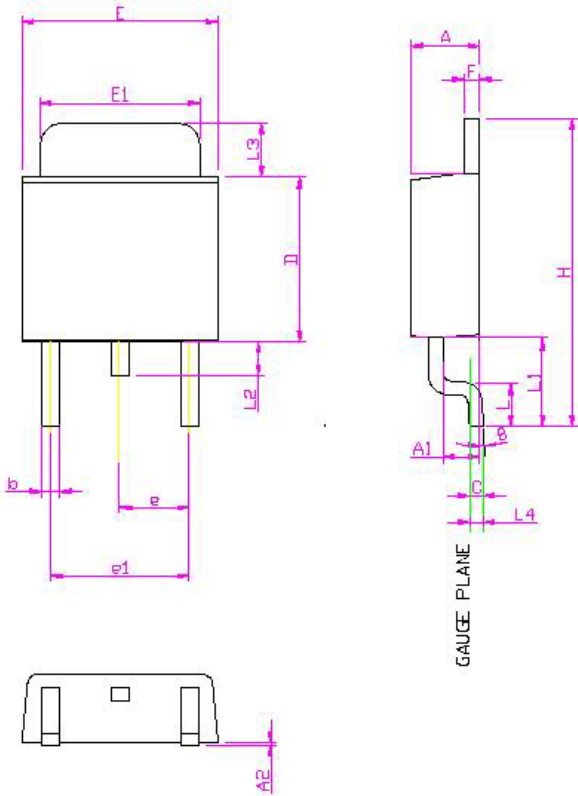

SYMBOL	MILLIMETERS		INCHES	
	MIN.	MAX.	MIN.	MAX.
	A	2.19	2.38	0.086
A1	0.89	1.27	0.035	0.050
A2	0.00	0.13	0.00	0.005
b	0.51	0.89	0.02	0.035
C	0.46	0.58	0.018	0.023
D	5.97	6.22	0.235	0.245
E	6.35	6.73	0.250	0.265
E1	5.21	5.46	0.205	0.215
e	2.28 BSC		0.090 BSC	
e1	3.96	5.18	0.156	0.204
F	0.46	0.58	0.018	0.023
L	1.40	1.78	0.055	0.070
L1	2.67(REF.)		0.105(REF.)	
L2	0.64	1.02	0.025	0.040
L3	1.52	2.03	0.060	0.080
L4	0.51 BSC		0.020 BSC	
H	9.40	10.4	0.370	0.410
φ	0"	8"	0"	8"

- Note :
1. Package body sizes exclude mold flash protrusions or gate burrs.
  2. Controlling dimension is millimeter, converted inch dimensions are not necessarily exact.
  3. Followed from JEDEC TO-252