

# DATA SHEET

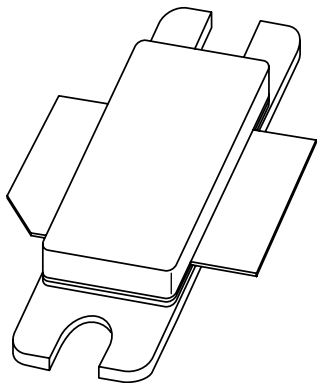

**BLL1214-250**

**L-band radar LDMOS transistor**

Product specification  
Supersedes data of 2002 Aug 06

2003 Aug 29

# L-band radar LDMOS transistor

# BLL1214-250

### FEATURES

- High power gain
- Easy power control
- Excellent ruggedness
- Source on mounting base eliminates DC isolators, reducing common mode inductance.

### APPLICATIONS

- L-band radar applications in the 1200 to 1400 MHz frequency range.

### DESCRIPTION

Silicon N-channel enhancement mode lateral D-MOS transistor encapsulated in a 2-lead flange package (SOT502A) with a ceramic cap. The common source is connected to the flange.

### PINNING - SOT502A

PIN	DESCRIPTION
1	drain
2	gate
3	source, connected to flange

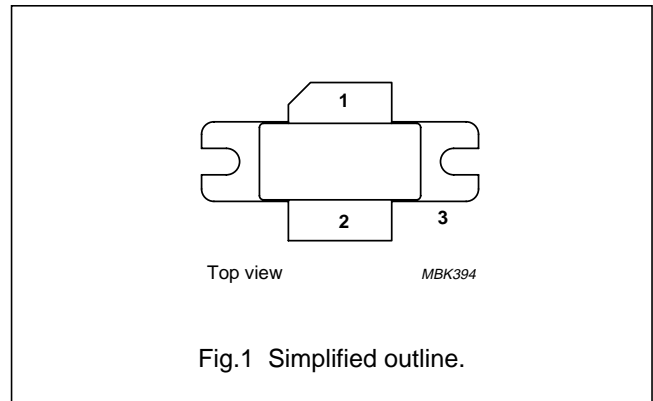

### QUICK REFERENCE DATA

RF performance at  $T_h = 25\text{ °C}$  in a common source test circuit.

MODE OF OPERATION	f (MHz)	$V_{DS}$ (V)	$I_{DQ}$ (mA)	$P_L$ (W)	$G_p$ (dB)	$\eta_D$ (%)	pulse droop (dB)	$t_r$ (ns)	$t_f$ (ns)
Pulsed class-AB; $t_p = 1\text{ ms}$ ; $\delta = 10\%$	1200 to 1400	36	150	250	>12	>42	<0.6	<100	<100

### LIMITING VALUES

In accordance with the Absolute Maximum Rating System (IEC 60134).

SYMBOL	PARAMETER	CONDITIONS	MIN.	MAX.	UNIT
$V_{DS}$	drain-source voltage		–	75	V
$V_{GS}$	gate-source voltage		–	$\pm 22$	V
$P_{tot}$	total power dissipation	$T_h \leq 70\text{ °C}$ ; $t_p = 1\text{ ms}$ ; $\delta = 10\%$	–	400	W
$T_{stg}$	storage temperature		–65	150	°C
$T_j$	junction temperature		–	200	°C

### CAUTION

This product is supplied in anti-static packing to prevent damage caused by electrostatic discharge during transport and handling. For further information, refer to Philips specs.: SNW-EQ-608, SNW-FQ-302A and SNW-FQ-302B.

## L-band radar LDMOS transistor

BLL1214-250

## THERMAL CHARACTERISTICS

SYMBOL	PARAMETER	CONDITIONS	VALUE	UNIT
$Z_{th\ j-h}$	thermal impedance from junction to heatsink	$T_h = 25\text{ °C}$ , note 1	0.17	K/W
$Z_{th\ j-h}$	thermal impedance from junction to heatsink	$T_h = 25\text{ °C}$ , note 2	0.32	K/W

## Notes

1. Thermal resistance is determined under RF operating conditions;  $t_p = 100\ \mu\text{s}$ ,  $\delta = 10\%$ .
2. Thermal resistance is determined under RF operating conditions;  $t_p = 1\ \text{ms}$ ,  $\delta = 10\%$ .

## CHARACTERISTICS

$T_j = 25\text{ °C}$  unless otherwise specified.

SYMBOL	PARAMETER	CONDITIONS	MIN.	TYP.	MAX.	UNIT
$V_{(BR)DSS}$	drain-source breakdown voltage	$V_{GS} = 0$ ; $I_D = 3\ \text{mA}$	75	–	–	V
$V_{GSth}$	gate-source threshold voltage	$V_{DS} = 10\ \text{V}$ ; $I_D = 300\ \text{mA}$	4	–	5	V
$I_{DSS}$	drain-source leakage current	$V_{GS} = 0$ ; $V_{DS} = 36\ \text{V}$	–	–	1	$\mu\text{A}$
$I_{DSX}$	on-state drain current	$V_{GS} = V_{GSth} + 9\ \text{V}$ ; $V_{DS} = 10\ \text{V}$	45	–	–	A
$I_{GSS}$	gate leakage current	$V_{GS} = \pm 20\ \text{V}$ ; $V_{DS} = 0$	–	–	1	$\mu\text{A}$
$g_{fs}$	forward transconductance	$V_{DS} = 10\ \text{V}$ ; $I_D = 10\ \text{A}$	–	9	–	S
$R_{DSon}$	drain-source on-state resistance	$V_{GS} = 9\ \text{V}$ ; $I_D = 10\ \text{A}$	–	60	–	$\text{m}\Omega$

## APPLICATION INFORMATION

RF performance in a common source class-AB circuit.  $T_h = 25\text{ °C}$ ;  $Z_{th\ mb-h} = 0.25\ \text{K/W}$ , unless otherwise specified.

MODE OF OPERATION	f (MHz)	$V_{DS}$ (V)	$I_{DQ}$ (mA)	$P_L$ (W)	$G_p$ (dB)	$\eta_D$ (%)	pulse droop (dB)	$t_r$ (ns)	$t_f$ (ns)
Pulsed class-AB; $t_p = 1\ \text{ms}$ ; $\delta = 10\%$	1200 to 1400	36	150	250	>12	>42	<0.6	<100	<100

## Ruggedness in class-AB operation

The BLL1214-250 is capable of withstanding a load mismatch corresponding to  $V_{SWR} = 3 : 1$  through all phases under the following conditions:  $V_{DS} = 36\ \text{V}$ ; frequency from 1200 MHz to 1400 MHz at rated load power.

## Typical impedance

FREQUENCY (GHZ)	$Z_S$ ( $\Omega$ )	$Z_L$ ( $\Omega$ )
1.20	$1.3 - j\ 2.8$	$1.1 - j\ 0.9$
1.25	$1.9 - j\ 2.9$	$1.0 - j\ 0.5$
1.30	$4.6 - j\ 2.9$	$0.8 - j\ 0.2$
1.35	$5.7 - j\ 0.3$	$0.7 - j\ 0.3$
1.40	$2.7 - j\ 1.8$	$0.6 - j\ 0.4$

L-band radar LDMOS transistor

BLL1214-250

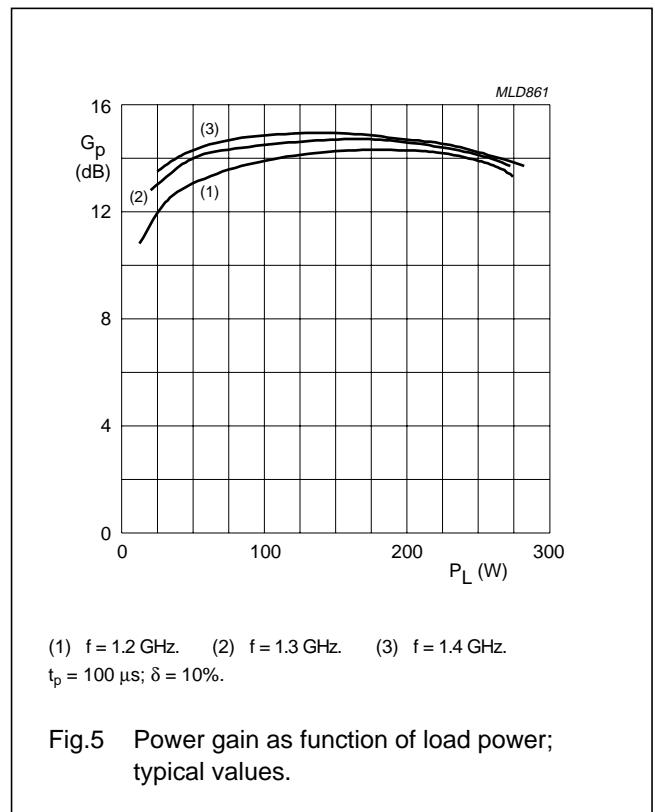
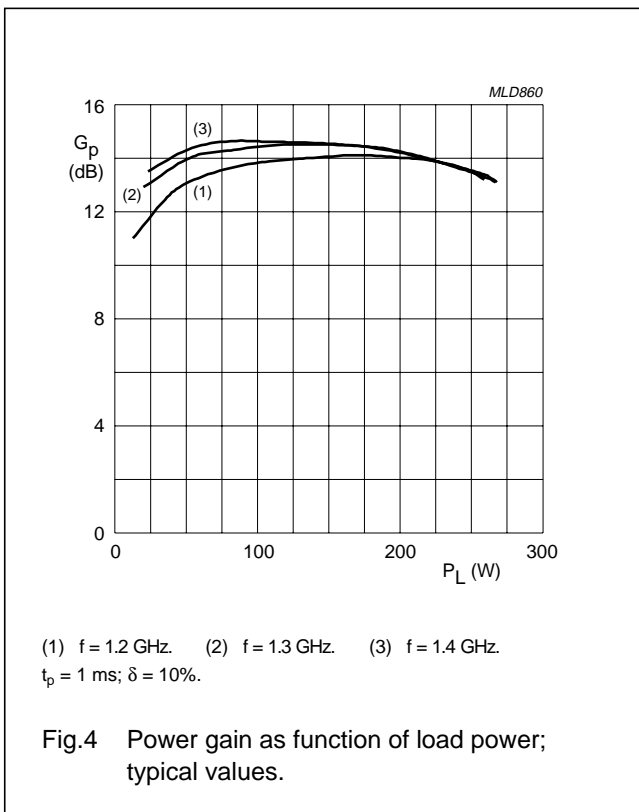
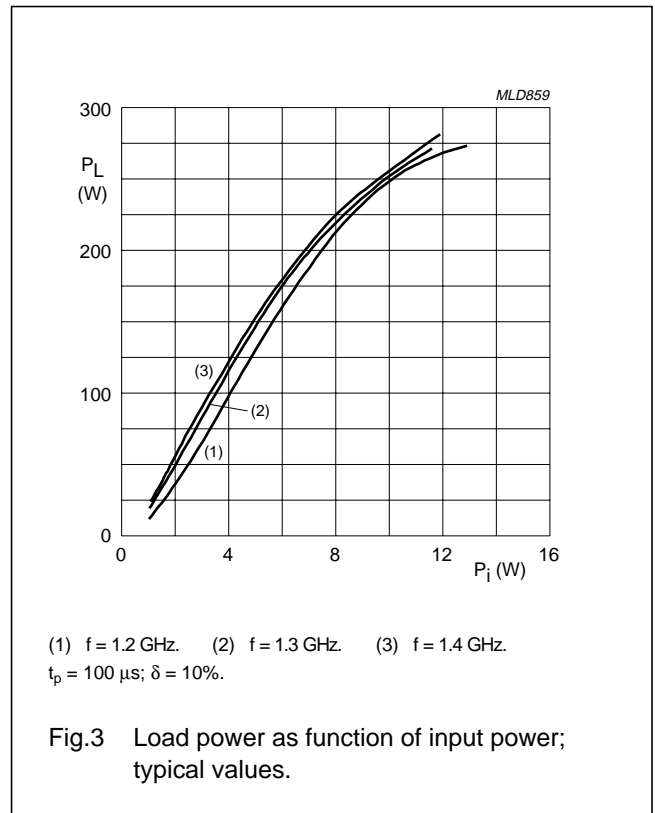
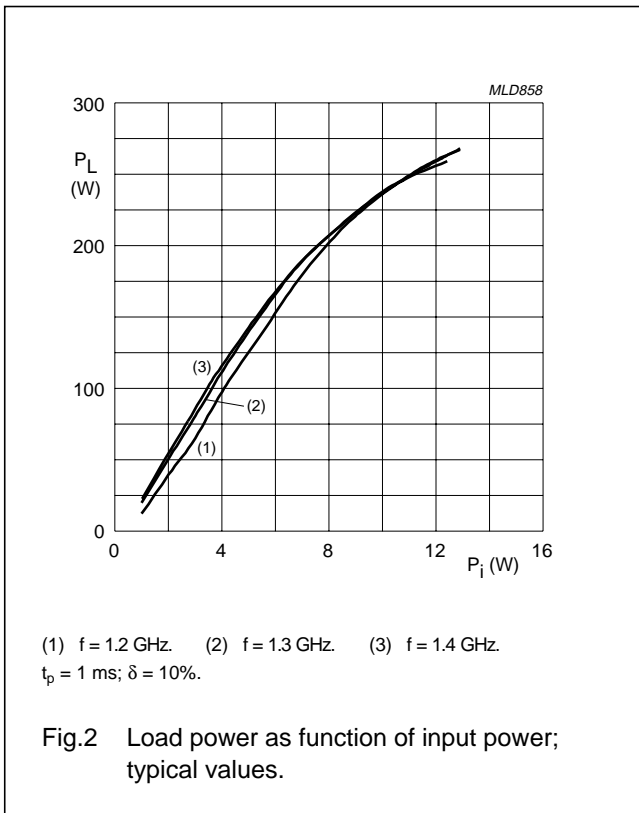

L-band radar LDMOS transistor

BLL1214-250

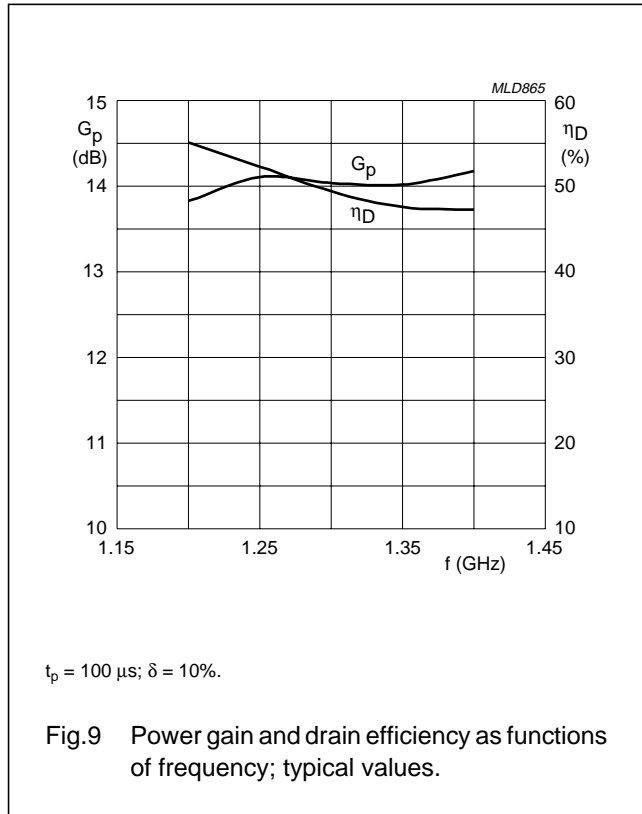
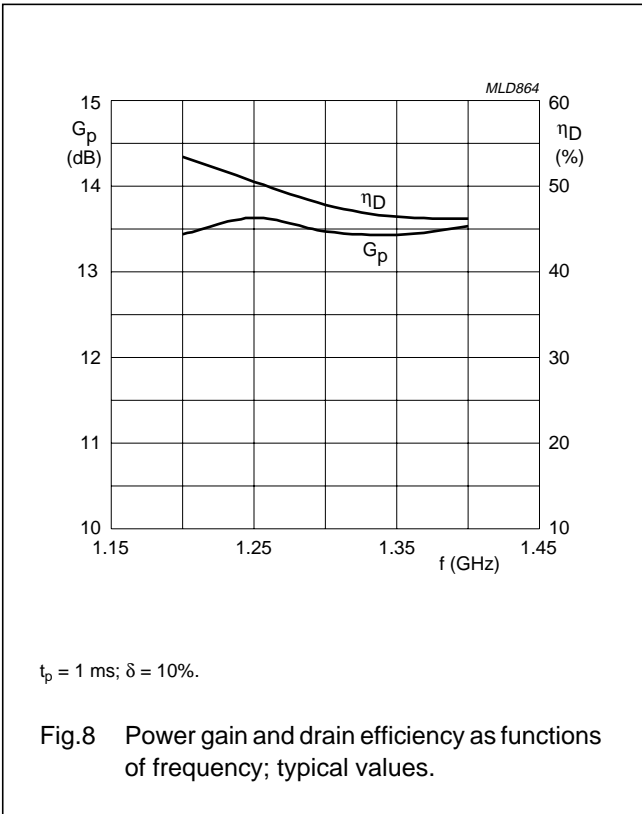
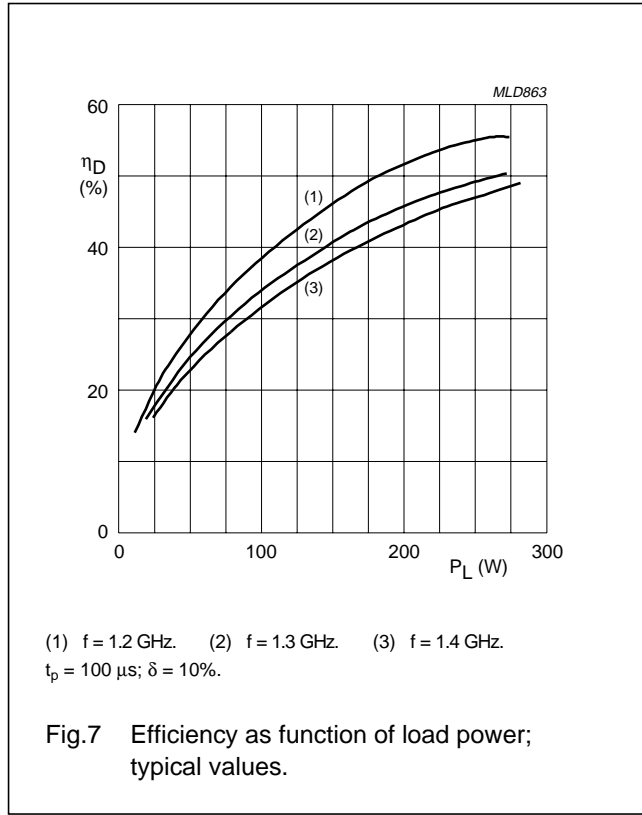
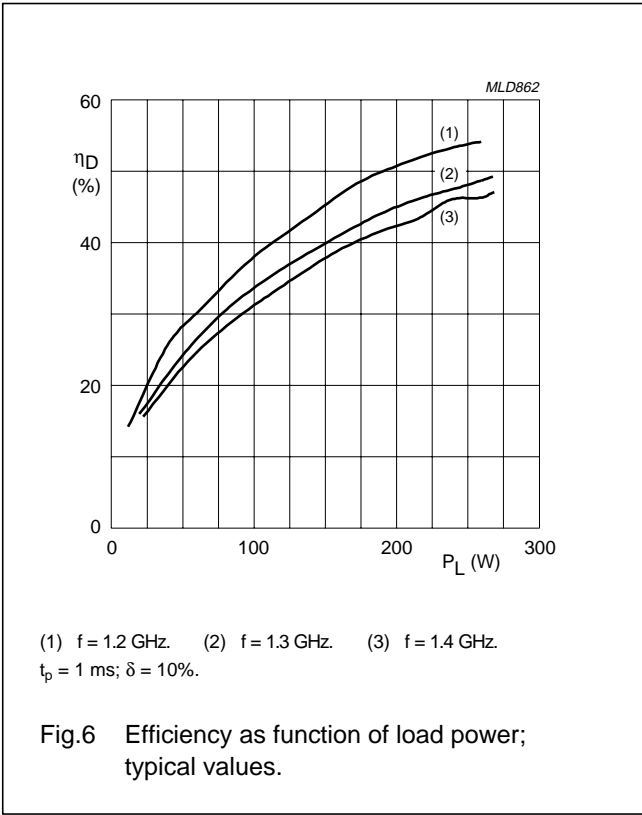

L-band radar LDMOS transistor

BLL1214-250

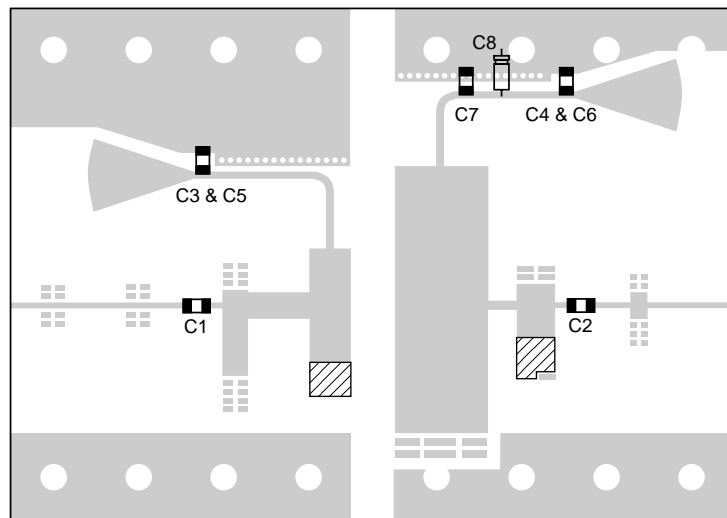
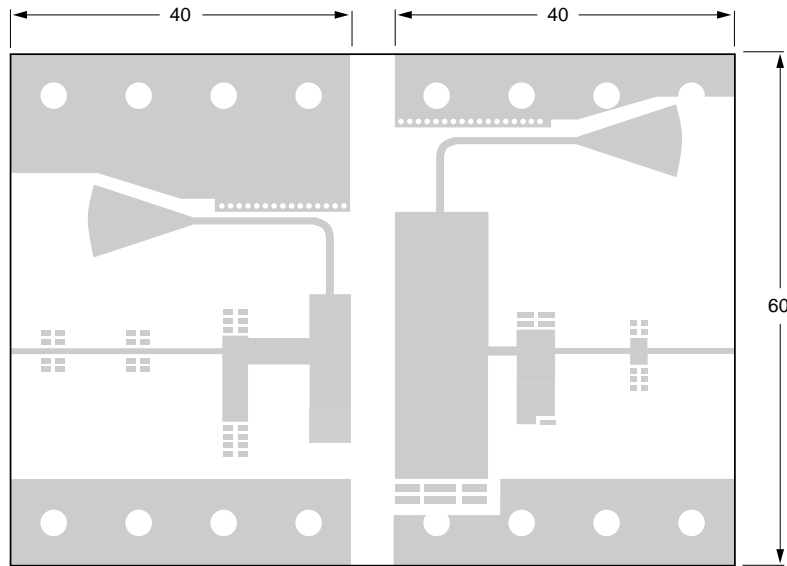

MLD866

Dimensions in mm.

Hatched area indicates standard tuning.

The components are situated on one side of the copper-clad Rogers Duroid 6010 printed-circuit board ( $\epsilon_r = 10.2$ , thickness = 0.64 mm).

The other side is unetched and serves as a ground plane.

Fig.10 Component layout.

## L-band radar LDMOS transistor

BLL1214-250

## List of components (see Fig.10)

COMPONENT	DESCRIPTION	VALUE	CATALOGUE NO.
C1, C3	capacitor	39 pF	ATC100A
C2, C4	capacitor	47 pF	ATC100A
C5, C6	capacitor	20 nF	ATC200B
C7	capacitor	36 pF	ATC200B
C8	electrolytic capacitor	100 $\mu$ F; 100 V	

L-band radar LDMOS transistor

BLL1214-250

PACKAGE OUTLINE

Flanged LDMOST ceramic package; 2 mounting holes; 2 leads

SOT502A

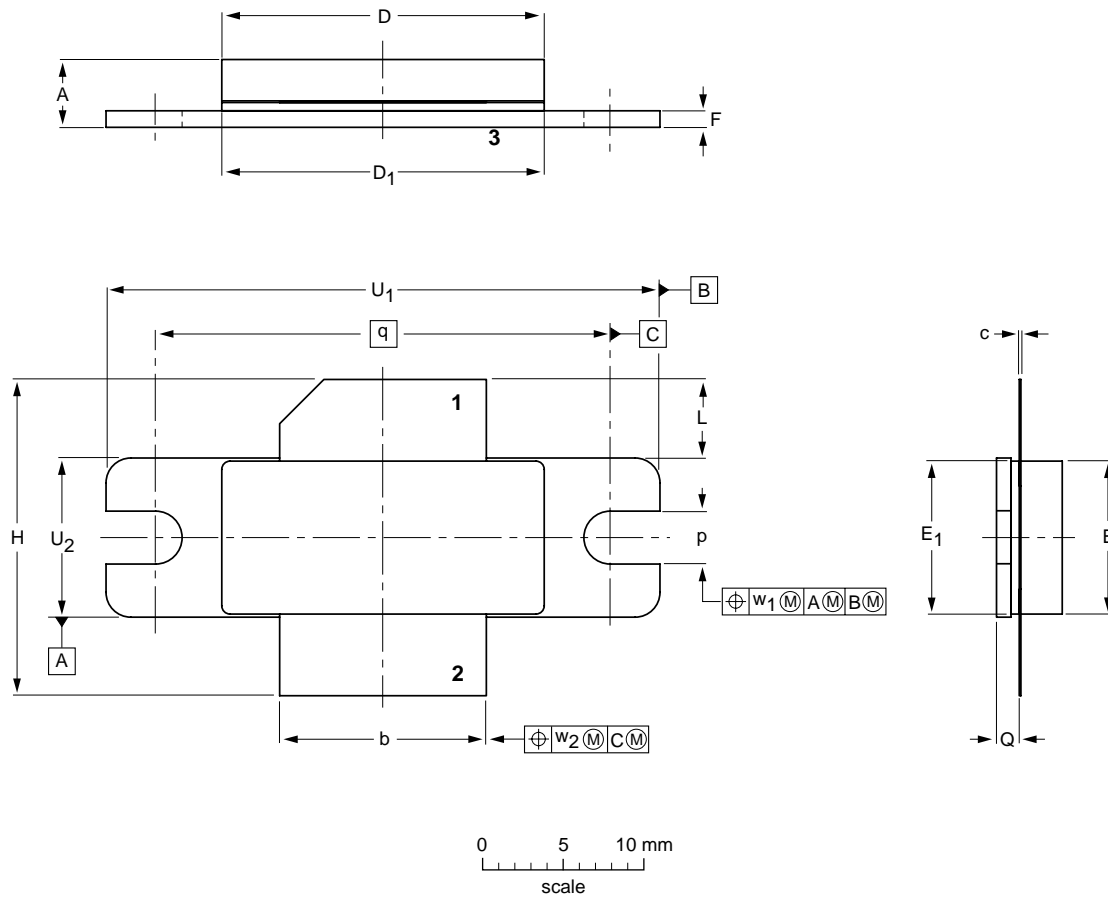

DIMENSIONS (millimetre dimensions are derived from the original inch dimensions)

UNIT	A	b	c	D	D <sub>1</sub>	E	E <sub>1</sub>	F	H	L	p	Q	q	U <sub>1</sub>	U <sub>2</sub>	w <sub>1</sub>	w <sub>2</sub>
mm	4.72 3.43	12.83 12.57	0.15 0.08	20.02 19.61	19.96 19.66	9.50 9.30	9.53 9.25	1.14 0.89	19.94 18.92	5.33 4.32	3.38 3.12	1.70 1.45	27.94	34.16 33.91	9.91 9.65	0.25	0.51
inches	0.186 0.135	0.505 0.495	0.006 0.003	0.788 0.772	0.786 0.774	0.374 0.366	0.375 0.364	0.045 0.035	0.785 0.745	0.210 0.170	0.133 0.123	0.067 0.057	1.100	1.345 1.335	0.390 0.380	0.01	0.02

OUTLINE VERSION	REFERENCES				EUROPEAN PROJECTION	ISSUE DATE
	IEC	JEDEC	JEITA			
SOT502A						99-12-28 03-01-10



## L-band radar LDMOS transistor

BLL1214-250

## DATA SHEET STATUS

LEVEL	DATA SHEET STATUS <sup>(1)</sup>	PRODUCT STATUS <sup>(2)(3)</sup>	DEFINITION
I	Objective data	Development	This data sheet contains data from the objective specification for product development. Philips Semiconductors reserves the right to change the specification in any manner without notice.
II	Preliminary data	Qualification	This data sheet contains data from the preliminary specification. Supplementary data will be published at a later date. Philips Semiconductors reserves the right to change the specification without notice, in order to improve the design and supply the best possible product.
III	Product data	Production	This data sheet contains data from the product specification. Philips Semiconductors reserves the right to make changes at any time in order to improve the design, manufacturing and supply. Relevant changes will be communicated via a Customer Product/Process Change Notification (CPCN).

## Notes

1. Please consult the most recently issued data sheet before initiating or completing a design.
2. The product status of the device(s) described in this data sheet may have changed since this data sheet was published. The latest information is available on the Internet at URL <http://www.semiconductors.philips.com>.
3. For data sheets describing multiple type numbers, the highest-level product status determines the data sheet status.

## DEFINITIONS

**Short-form specification** — The data in a short-form specification is extracted from a full data sheet with the same type number and title. For detailed information see the relevant data sheet or data handbook.

**Limiting values definition** — Limiting values given are in accordance with the Absolute Maximum Rating System (IEC 60134). Stress above one or more of the limiting values may cause permanent damage to the device. These are stress ratings only and operation of the device at these or at any other conditions above those given in the Characteristics sections of the specification is not implied. Exposure to limiting values for extended periods may affect device reliability.

**Application information** — Applications that are described herein for any of these products are for illustrative purposes only. Philips Semiconductors make no representation or warranty that such applications will be suitable for the specified use without further testing or modification.

## DISCLAIMERS

**Life support applications** — These products are not designed for use in life support appliances, devices, or systems where malfunction of these products can reasonably be expected to result in personal injury. Philips Semiconductors customers using or selling these products for use in such applications do so at their own risk and agree to fully indemnify Philips Semiconductors for any damages resulting from such application.

**Right to make changes** — Philips Semiconductors reserves the right to make changes in the products - including circuits, standard cells, and/or software - described or contained herein in order to improve design and/or performance. When the product is in full production (status 'Production'), relevant changes will be communicated via a Customer Product/Process Change Notification (CPCN). Philips Semiconductors assumes no responsibility or liability for the use of any of these products, conveys no licence or title under any patent, copyright, or mask work right to these products, and makes no representations or warranties that these products are free from patent, copyright, or mask work right infringement, unless otherwise specified.

# ***Philips Semiconductors – a worldwide company***

## **Contact information**

For additional information please visit <http://www.semiconductors.philips.com>. Fax: +31 40 27 24825

For sales offices addresses send e-mail to: [sales.addresses@www.semiconductors.philips.com](mailto:sales.addresses@www.semiconductors.philips.com).

© Koninklijke Philips Electronics N.V. 2003

SCA75

All rights are reserved. Reproduction in whole or in part is prohibited without the prior written consent of the copyright owner.

The information presented in this document does not form part of any quotation or contract, is believed to be accurate and reliable and may be changed without notice. No liability will be accepted by the publisher for any consequence of its use. Publication thereof does not convey nor imply any license under patent- or other industrial or intellectual property rights.

Printed in The Netherlands

613524/03/pp10

Date of release: 2003 Aug 29

Document order number: 9397 750 11576

*Let's make things better.*

**Philips  
Semiconductors**



**PHILIPS**