

Built-in Diode at C-E  
Low  $V_{CE}(\text{sat})$

# 2SA1568

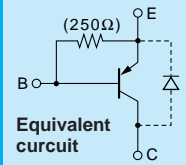

Silicon PNP Epitaxial Planar Transistor (Complement to type 2SC4065)

Application : DC Motor Driver, Chopper Regulator and General Purpose

**Absolute maximum ratings** ( $T_a=25^\circ\text{C}$ )

Symbol	2SA1568	Unit
$V_{CB0}$	-60	V
$V_{CE0}$	-60	V
$V_{EB0}$	-6	V
$I_C$	$\pm 12$	A
$I_B$	-3	A
$P_C$	35( $T_C=25^\circ\text{C}$ )	W
$T_{jg}$	150	$^\circ\text{C}$
$T_{stg}$	-55 to +150	$^\circ\text{C}$

**Electrical Characteristics** ( $T_a=25^\circ\text{C}$ )

Symbol	Conditions	2SA1568	Unit
$I_{CB0}$	$V_{CB}=-60\text{V}$	-100max	$\mu\text{A}$
$I_{EB0}$	$V_{EB}=-6\text{V}$	-60max	mA
$V_{(BR)CEO}$	$I_C=-25\text{mA}$	-60min	V
$h_{FE}$	$V_{CE}=-1\text{V}, I_C=-6\text{A}$	50min	
$V_{CE}(\text{sat})$	$I_C=-6\text{A}, I_B=-0.3\text{A}$	-0.35max	V
$V_{FEC}$	$I_{ECO}=-10\text{A}$	-2.5max	V
$f_T$	$V_{CE}=-12\text{V}, I_E=0.5\text{A}$	40typ	MHz
$COB$	$V_{CB}=-10\text{V}, f=1\text{MHz}$	330typ	pF

**External Dimensions FM20 (TO220F)**

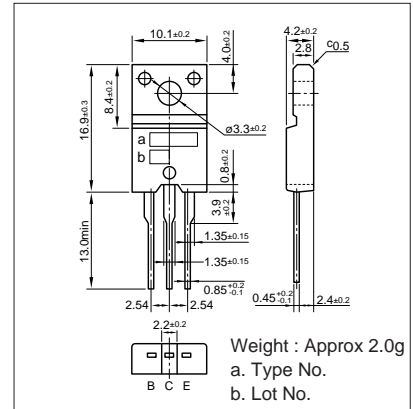

**Typical Switching Characteristics (Common Emitter)**

$V_{CC}$ (V)	$R_L$ ( $\Omega$ )	$I_C$ (A)	$V_{BB1}$ (V)	$V_{BB2}$ (V)	$I_{B1}$ (mA)	$I_{B2}$ (mA)	$t_{on}$ ( $\mu\text{s}$ )	$t_{stg}$ ( $\mu\text{s}$ )	$t_f$ ( $\mu\text{s}$ )
-24	4	-6	-10	5	-120	120	0.4typ	0.4typ	0.2typ

**$I_C-V_{CE}$  Characteristics (Typical)**

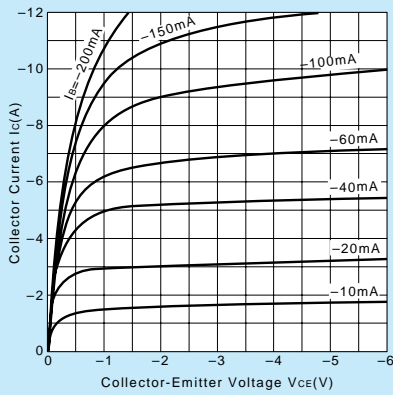

**$V_{CE}(\text{sat})-I_B$  Characteristics (Typical)**

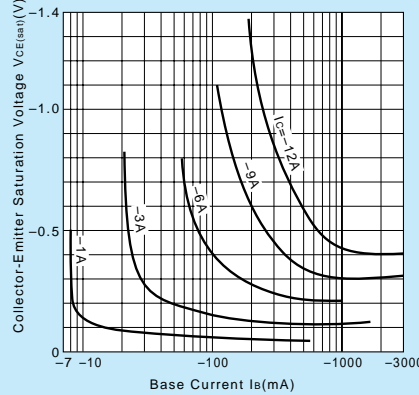

**$I_C-V_{BE}$  Temperature Characteristics (Typical)**

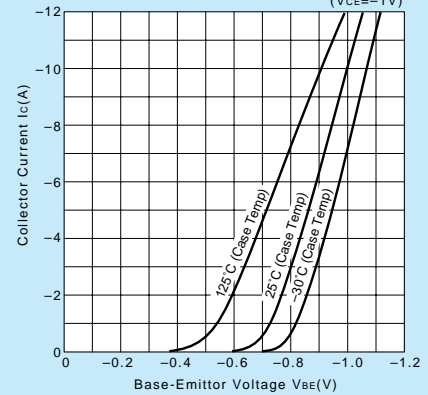

**$h_{FE}-I_C$  Characteristics (Typical)**

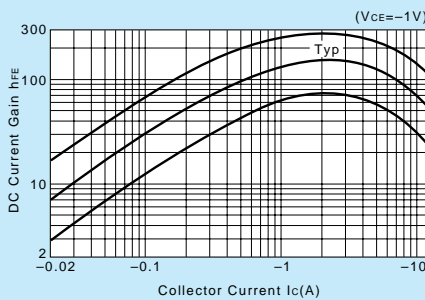

**$h_{FE}-I_C$  Temperature Characteristics (Typical)**

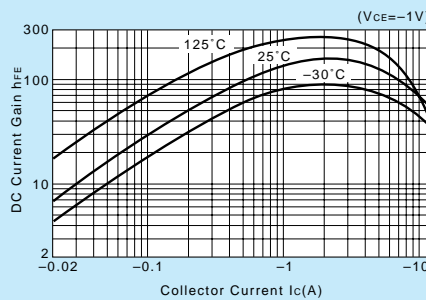

**$\theta_{j-a}-t$  Characteristics**

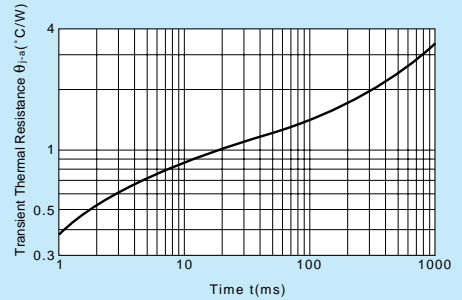

**$f_T-I_E$  Characteristics (Typical)**

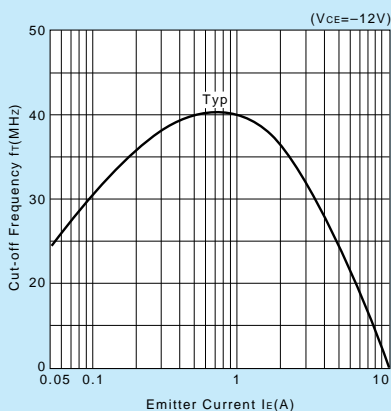

**Safe Operating Area (Single Pulse)**

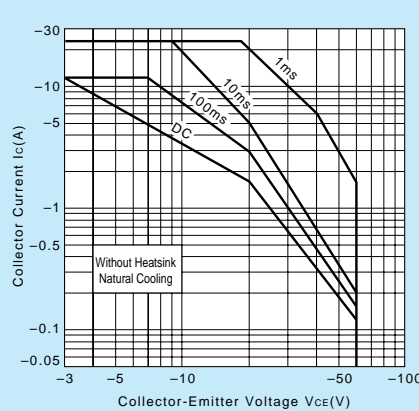

**$P_C-T_a$  Derating**

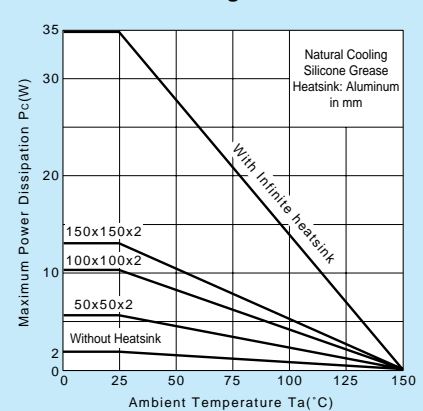

This datasheet has been downloaded from:

[www.DatasheetCatalog.com](http://www.DatasheetCatalog.com)

Datasheets for electronic components.