

SIPMOS[®] Small-Signal Transistor

- N channel
- Depletion mode
- High dynamic resistance

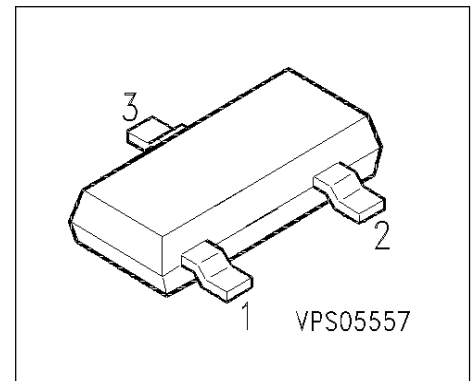

Pin 1	Pin 2	Pin 3
G	S	D

Type	V_{DS}	I_D	$R_{DS(on)}$	Package	Ordering Code
BSS 159	50 V	0.16 A	8 Ω	SOT-23	Q67050-T6

Maximum Ratings

Parameter	Symbol	Values	Unit
Drain source voltage	V_{DS}	50	V
Drain-gate voltage	V_{DGR}	50	
$R_{GS} = 20 \text{ k}\Omega$			
Gate source voltage	V_{GS}	± 14	
Gate-source peak voltage, aperiodic	V_{gs}	± 20	
Continuous drain current	I_D	0.16	A
$T_A = 25 \text{ }^\circ\text{C}$			
DC drain current, pulsed	I_{Dpuls}	0.48	
$T_A = 25 \text{ }^\circ\text{C}$			
Power dissipation	P_{tot}	0.36	W
$T_A = 25 \text{ }^\circ\text{C}$			
Chip or operating temperature	T_j	-55 ... + 150	$^\circ\text{C}$
Storage temperature	T_{stg}	-55 ... + 150	
Thermal resistance, chip to ambient air	R_{thJA}	≤ 350	K/W
Thermal resistance, chip-substrate - reverse side ¹⁾	R_{thJSR}	≤ 285	
DIN humidity category, DIN 40 040		E	
IEC climatic category, DIN IEC 68-1		55 / 150 / 56	

1) For package mounted on aluminium 15 mm x 16.7 mm x 0.7 mm.

Electrical Characteristics, at $T_j = 25^\circ\text{C}$, unless otherwise specified

Parameter	Symbol	Values			Unit
		min.	typ.	max.	
Static Characteristics					
Drain-source breakdown voltage $V_{GS} = -10\text{ V}$, $I_D = 250\ \mu\text{A}$	$V_{(BR)DSV}$	50	-	-	V
Gate threshold voltage $V_{DS} = 3\text{ V}$, $I_D = 10\ \mu\text{A}$	$V_{GS(th)}$	-3	-2.5	-1.5	
Drain-source cutoff current $V_{DS} = 50\text{ V}$, $V_{GS} = -10\text{ V}$, $T_j = 25\ ^\circ\text{C}$ $V_{DS} = 50\text{ V}$, $V_{GS} = -10\text{ V}$, $T_j = 125\ ^\circ\text{C}$	I_{DSV}	-	-	1	μA
On-state drain current $V_{GS} = 0\text{ V}$, $V_{DS} = 10\text{ V}$	$I_{D(on)}$	70	200	-	mA
Gate-source leakage current $V_{GS} = 20\text{ V}$, $V_{DS} = 0\text{ V}$	I_{GSS}	-	10	100	nA
Drain-Source on-resistance $V_{GS} = 0\text{ V}$, $I_D = 0.07\text{ A}$	$R_{DS(on)}$	-	4	8	Ω

Electrical Characteristics, at $T_j = 25^\circ\text{C}$, unless otherwise specified

Parameter	Symbol	Values			Unit
		min.	typ.	max.	

Dynamic Characteristics

Transconductance $V_{DS} \geq 2 * I_D * R_{DS(on)max}, I_D = 0.16 \text{ A}$	g_{fs}	0.1	0.16	-	S
Input capacitance $V_{GS} = -4.5 \text{ V}, V_{DS} = 25 \text{ V}, f = 1 \text{ MHz}$	C_{iss}	-	70	100	pF
Output capacitance $V_{GS} = -4.5 \text{ V}, V_{DS} = 25 \text{ V}, f = 1 \text{ MHz}$	C_{oss}	-	15	25	
Reverse transfer capacitance $V_{GS} = -4.5 \text{ V}, V_{DS} = 25 \text{ V}, f = 1 \text{ MHz}$	C_{rss}	-	6	9	
Turn-on delay time $V_{DD} = 30 \text{ V}, V_{GS} = -5... + 5 \text{ V}, I_D = 0.28 \text{ A}$ $R_{GS} = 50 \Omega$	$t_{d(on)}$	-	7	11	ns
Rise time $V_{DD} = 30 \text{ V}, V_{GS} = -5... + 5 \text{ V}, I_D = 0.28 \text{ A}$ $R_{GS} = 50 \Omega$	t_r	-	11	17	
Turn-off delay time $V_{DD} = 30 \text{ V}, V_{GS} = -5... + 5 \text{ V}, I_D = 0.28 \text{ A}$ $R_{GS} = 50 \Omega$	$t_{d(off)}$	-	13	17	
Fall time $V_{DD} = 30 \text{ V}, V_{GS} = -5... + 5 \text{ V}, I_D = 0.28 \text{ A}$ $R_{GS} = 50 \Omega$	t_f	-	14	19	

Electrical Characteristics, at $T_j = 25^\circ\text{C}$, unless otherwise specified

Parameter	Symbol	Values			Unit
		min.	typ.	max.	

Reverse Diode

Inverse diode continuous forward current $T_A = 25^\circ\text{C}$	I_S	-	-	0.1	A
Inverse diode direct current, pulsed $T_A = 25^\circ\text{C}$	I_{SM}	-	-	0.3	
Inverse diode forward voltage $V_{GS} = 0\text{ V}, I_F = 0.3\text{ A}$	V_{SD}	-	0.8	1.3	V