

MINIATURE SIGNAL RELAY EC2 SERIES

COMPACT AND LIGHTWEIGHT, SMALL MOUNTING SIZE,
HIGH BREAKDOWN VOLTAGE

DESCRIPTION

The EC2 series has reduced mounting space but sustained high-performance of NEC EA2 series. Furthermore, it complies with 2500 V surge-voltage requirement of Bellcore specification.

FEATURES

- Compact and light weight
- 2 form c contact arrangement
- Low power consumption
- Reduced mounting space : 15 mm × 7.5 mm
- High-breakdown voltage of coil to contacts :
1500 Vac, 2500 V (rise time : 2 μ s, fall time : 10 μ s)
- Capable of High-power switching :
700 Vac, 4.2 A, 4 times in case of accident
- UL recognized (E73266), CAS certified (LR46266)

APPLICATIONS

Electronic switching systems, PBX, terminal equipment, telephone systems.

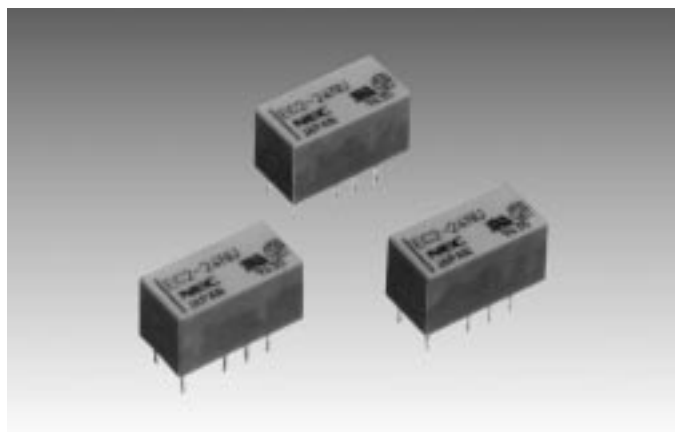

For Right Use of Miniature Relays

DO NOT EXCEED MAXIMUM RATINGS.

Do not use relays under exceeding conditions such as over ambient temperature, over voltage and over current. Incorrect use could result in abnormal heating, damage to related parts or cause burning.

READ CAUTIONS IN THE SELECTION GUIDE.

Read the cautions described in NEC's "Miniature Relays" (ER0046EJ*) when you choose relays for your application.

OUTLINE DRAWING AND DIMENSIONS

PAD LAYOUT (bottom view)

Unit : mm (inch)

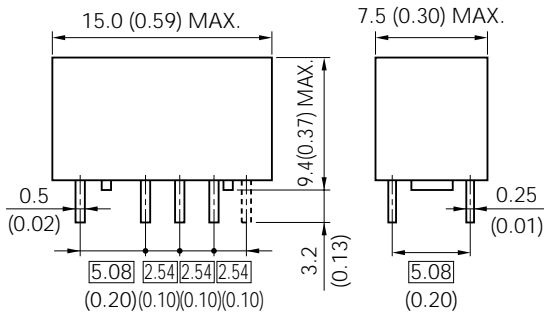

Note. General tolerance : ± 0.2 (± 0.008)
 Dimensions in show basic size.
 NJ type : Leads-2.8 mm (0.11)

Non-latch and Single coil latch

Double coil latch

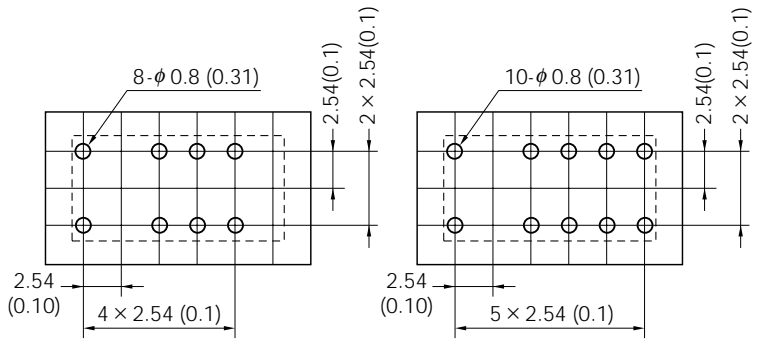

Note. General tolerance : ± 0.1 (± 0.004)

MARKINGS

Standard type

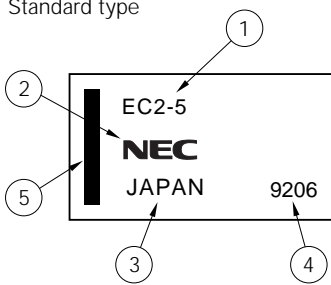

- ① Part number
- ② Manufacturer
- ③ Country of origin
- ④ Date code
- ⑤ Index mark of relay direction (pin No. 1, 12)
- ⑥ UL, CSA Marking

UL recognized,
 CSA certified type

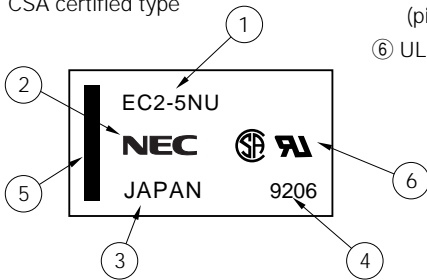

SAFETY STANDARD AND RATING

UL Recognized (UL508)* File No E73266	CSA Certified (CSA C22.2 No 14) File No LR46266
30 Vdc, 2A (Resistive) 110 Vdc, 0.3A (Resistive) 125 Vdc, 0.5A (Resistive)	

* Spacing : UL114, UL478

TUV Certificate (EN60255 / IEC60255)
No. R 9751153 (Nonlatch and Single-coil-latch)
Creepage and clearance of coil to contact is more than 2 mm. (According EN60950)
Basic insulation class

PIN CONFIGURATIONS (bottom view)

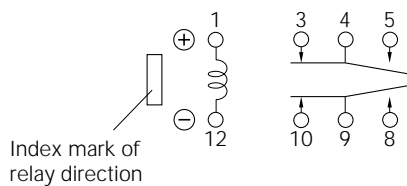

Non-latch type
 (not energized position)

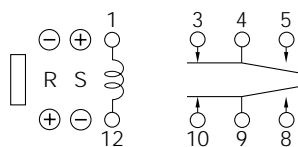

Single coil latch type
 (reset position)

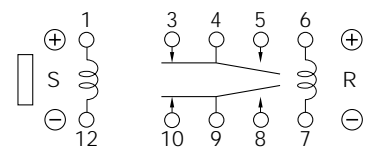

Double coil latch type
 (reset position)

S : Coil polarity of set (operate)
 R : Coil polarity of reset (release)

PART NUMBER SYSTEM

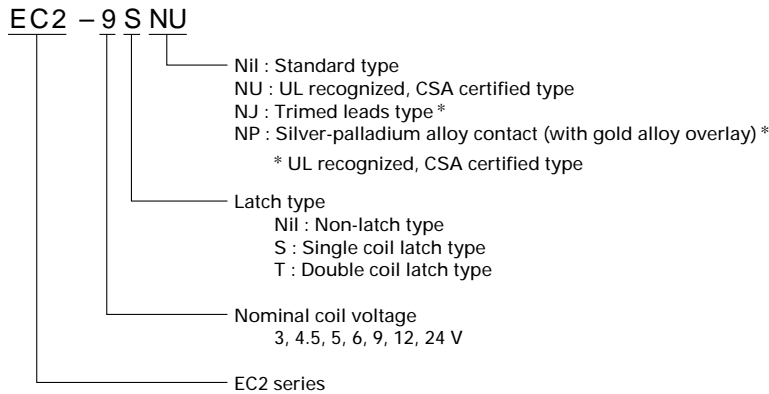

PERFORMANCE CHARACTERISTICS

Contact Form		2 Form c	
Contact Material		Silver alloy with gold alloy overlay	
Contact Ratings (UL / CSA Rating)	Maximum Switching Power	60 W, 125 VA	
	Maximum Switching Voltage	220 Vdc, 250 Vac	
	Maximum Switching Current	2 A	
	Maximum Carrying Current	2 A	
Minimum Contact Ratings		10 mVdc, 10 μ A *1	
Initial Contact Resistance		50 m Ω typ. (Initial)	
Nominal Operating Power	Non-Latch Type	140 mW (3 to 12 V), 200 mW (24 V)	
	Single Coil Latch Type	100 mW	
	Single Coil Latch Type	140 mW	
Operate Time (Excluding Bounce)		Approx. 2 ms	
Release Time (Excluding Bounce)		Approx. 1 ms without diode	
Insulation Resistance		1000 M Ω at 500 Vdc	
Breakdown Voltage	Between Open Contacts	1000 Vac (for one minute)	
	Between Adjacent Contacts	1500 V surge (10 \times 160 μ s *2)	
	Between Coil and Contact	1500 Vac (for one minute) 2500 V surge, (2 \times 10 μ s *3)	Double Coil 1000 Vac (for one minute) Latch type 1500 V surge (10 \times 160 μ s *2)
Shock Resistance		735 m/s ² (75 G) (misoperating) 980 m/s ² (100 G) (destructive failure)	
Vibration Resistance		10 to 55 Hz double amplitude of 3 mm (20 G) (misoperating) 10 to 55 Hz, double amplitude of 5 mm (30 G) (Destructive failure)	
Ambient Temperature		-40 to 85°C	
Coil Temperature Rise		18 degrees at nominal coil voltage (140 mW)	
Running specifications	No-load	1 \times 10 ⁸ *4 operations (Non-latch type) 1 \times 10 ⁷ operations (latch type)	
	Load	50 Vdc, 0.1 A (resistive) 1 \times 10 ⁶ operations at 85°C, 2 Hz	
		10 Vdc, 10 mA (resistive) 1 \times 10 ⁶ operations at 85°C, 2 Hz	
Weight		Approx. 1.9 g	

*1 This value is reference value in the resistance load.

Minimum capacity changes depending on switching frequency and environment temperatur and the load.

*2 rise time : 10 μ s, fall time : 160 μ s

*3 rise time : 2 μ s, fall time : 10 μ s

*4 This shows a number of operation where it can be running by which a fatal defect is not caused, and a number of operation by which a steady characteristic is maintained is 1 \times 10⁷ times.

PRODUCT LINEUP

Non-latch Type

at 20°C

Nominal Coil Voltage (Vdc)	Coil Resistance (Ω) $\pm 10\%$	Must Operate Voltage (Vdc)	Must Release Voltage (Vdc)
3	64.3	2.25	0.3
4.5	145	3.38	0.45
5	178	3.75	0.5
6	257	4.5	0.6
9	579	6.75	0.9
12	1028	9	1.2
24	2880	18	2.4

Single-Coil Latch Type

at 20°C

Nominal Coil Voltage (Vdc)	Coil Resistance (Ω) $\pm 10\%$	Must Operate Voltage (Vdc)	Must Release Voltage (Vdc)
3	90	2.25	2.25
4.5	202.5	3.38	3.38
5	250	3.75	3.75
6	360	4.5	4.5
9	810	6.75	6.75
12	1440	9	9
24	5760	18	18

Double-Coil Latch Type ** (Can not be driven by reverse polarity for reverse operation.)

at 20°C

Nominal Coil Voltage (Vdc)	Coil Resistance (Ω) $\pm 10\%$		Must Operate Voltage (Vdc)	Must Release Voltage (Vdc)
3	S	64.3	2.25	-
	R	64.3	-	2.25
4.5	S	145	3.38	-
	R	145	-	3.38
5	S	178	3.75	-
	R	178	-	3.75
6	S	257	4.5	-
	R	257	-	4.5
9	S	579	6.75	-
	R	579	-	6.75
12	S	1028	9	-
	R	1028	-	9
24	S	4114	18	-
	R	4114	-	18

Note * Test by pulse voltage

** S : Set coil (pin No.1... \oplus , pin No.5... \ominus) R: Reset coil (pin No.10... \oplus , pin No.6... \ominus)

The latch type relays should be initialized at appointed position before using, and should be energized to specific polarity by a bone polarity to avoid wrong operation.

Any special coil requirement, please contact NEC for availability.

TYPICAL PERFORMANCE DATA

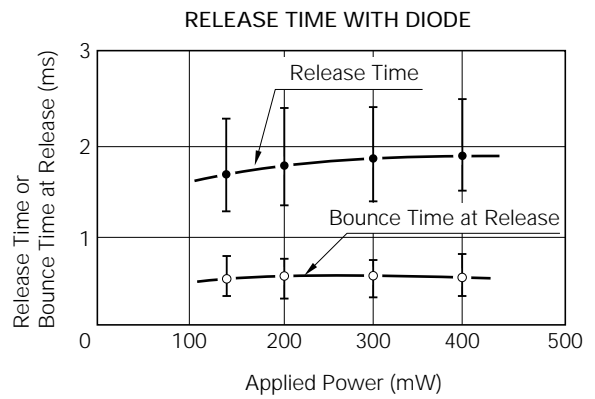
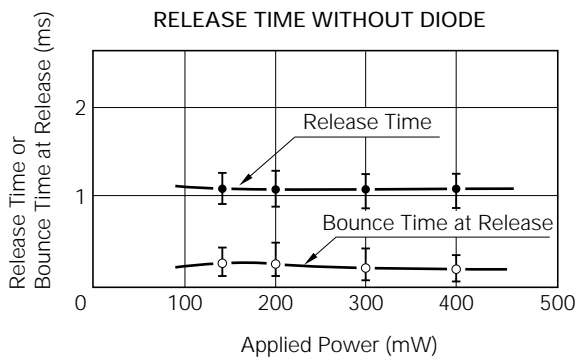
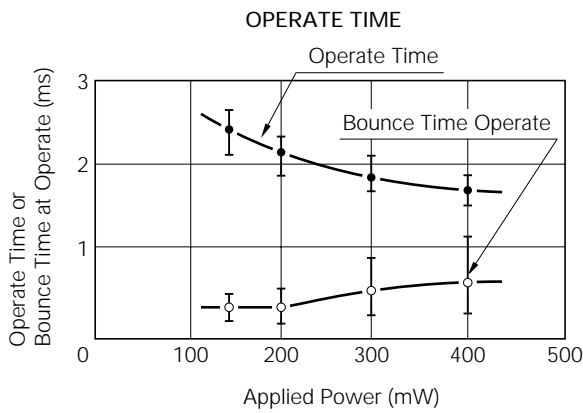
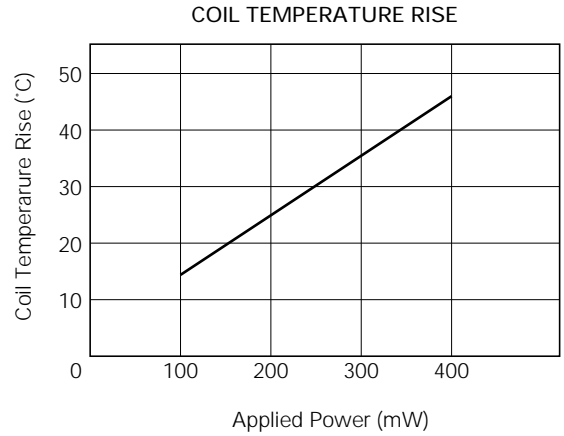
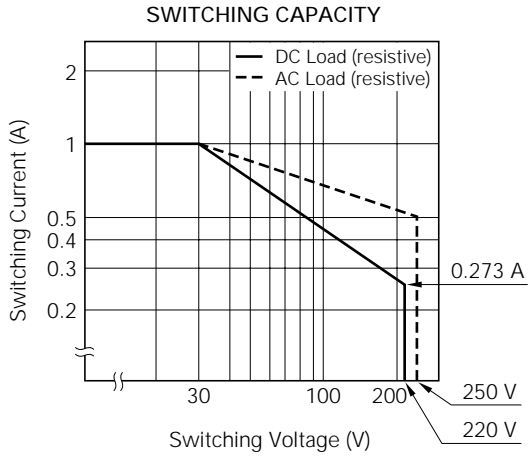

RUNNING SPECIFICATIONS (No load)

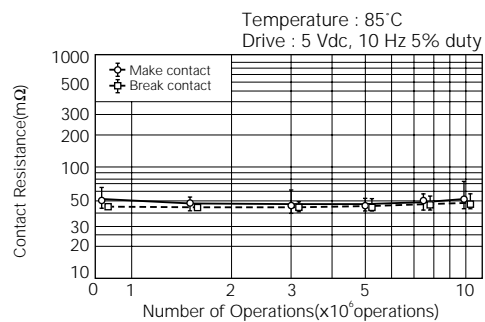
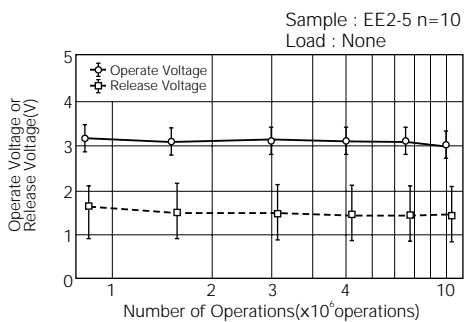

BREAKDOWN VOLTAGE

Sample : EC2-5

(a) Between Open Contacts (n = 10 pcs)

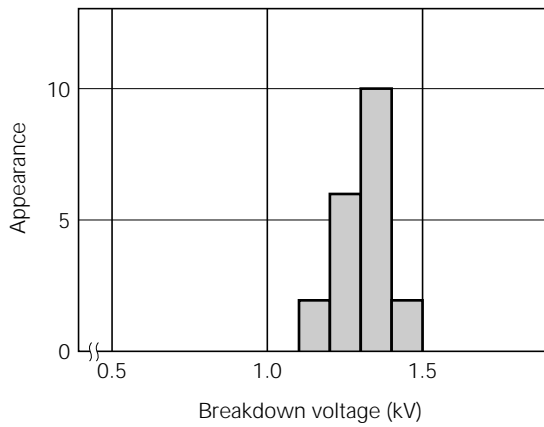

(a) Between Adjacent Contacts (n = 10 pcs)

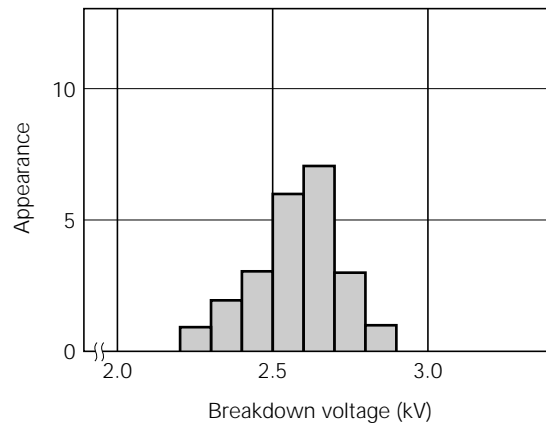

(a) Between Coil and Contacts (n = 25 pcs)

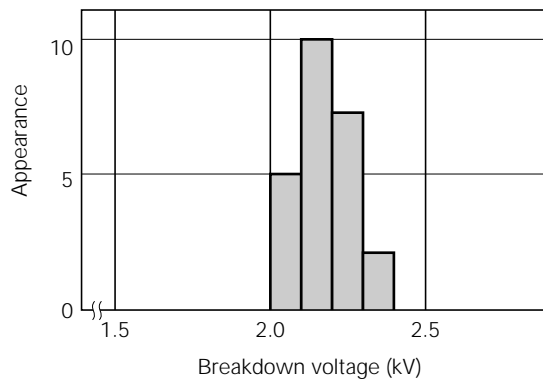

MAGNETIC INTERFERENCE

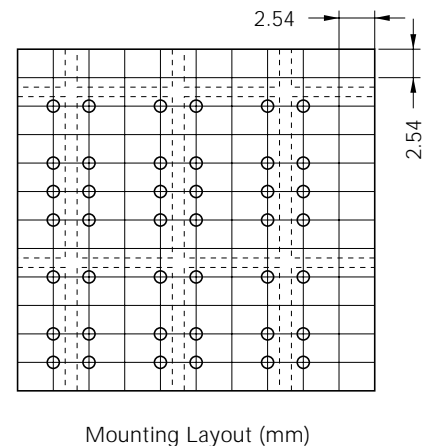
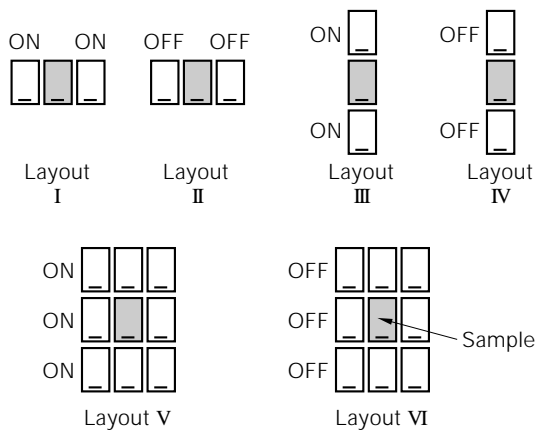
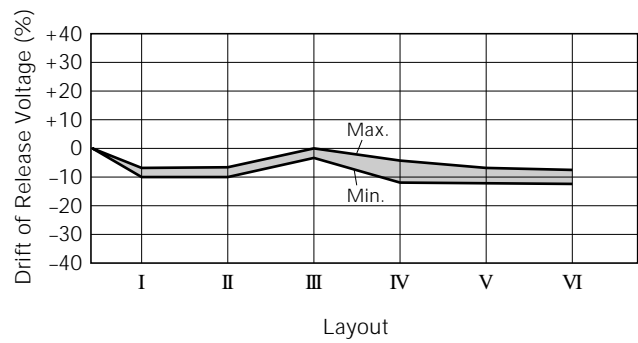
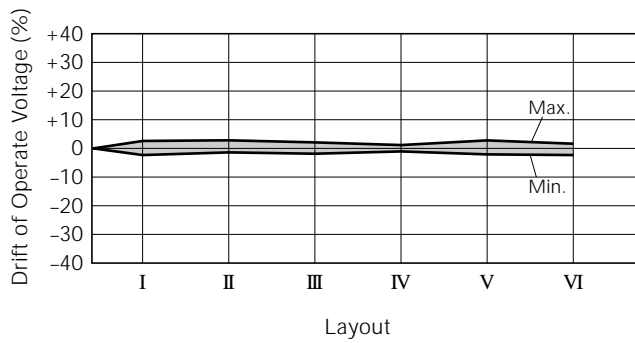

PACKAGE

Dimensions of Relay Tube (Unit : mm)

35 pieces / Tube
 Material : Polyvinyl chloride
 (anti-static treated)

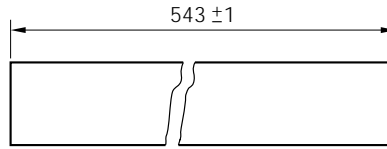
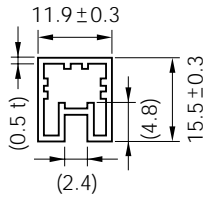

() Reference

Outline of Package

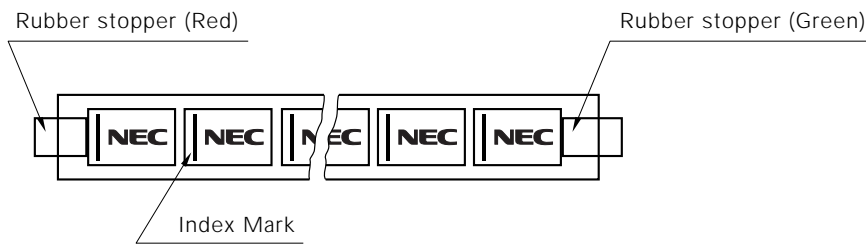

GUIDE TO APPLICATIONS

1. When connecting coils, refer to the pin configuration to prevent misoperation or malfunction.
2. The latch type relay should be initialized at the appointed position (set or reset position) when using, and should be energized or deenergized to the specified polarity to avoid wrong operations by reversed contact state.
3. Soldering should be done at 250 °C within 10 sec.
4. Ultrasonic cleaning is not recommended to keep reliable contact performance. Alcohol based solvents are available as proper solvents.
5. Minimum contact load of the relay is 10 mV, 10 μA.
 This value is a reference value in the resistance load.
 Minimum capacity changes depending on swiching frequency and environment temperature and the load.

No part of this document may be copied or reproduced in any form or by any means without the prior written consent of NEC Corporation. NEC Corporation assumes no responsibility for any errors which may appear in this document.

NEC Corporation does not assume any liability for infringement of patents, copyrights or other intellectual property rights of third parties by or arising from use of a device described herein or any other liability arising from use of such device. No license, either express, implied or otherwise, is granted under any patents, copyrights or other intellectual property rights of NEC Corporation or others.

While NEC Corporation has been making continuous effort to enhance the reliability of its electronic components, the possibility of defects cannot be eliminated entirely. To minimize risks of damage or injury to persons or property arising from a defect in an NEC electronic component, customers must incorporate sufficient safety measures in its design, such as redundancy, fire-containment, and anti-failure features.

NEC devices are classified into the following three quality grades:

"Standard", "Special", and "Specific". The Specific quality grade applies only to devices developed based on a customer designated "quality assurance program" for a specific application. The recommended applications of a device depend on its quality grade, as indicated below. Customers must check the quality grade of each device before using it in a particular application.

Standard: Computers, office equipment, communications equipment, test and measurement equipment, audio and visual equipment, home electronic appliances, machine tools, personal electronic equipment and industrial robots

Special: Transportation equipment (automobiles, trains, ships, etc.), traffic control systems, anti-disaster systems, anti-crime systems, safety equipment and medical equipment (not specifically designed for life support)

Specific: Aircrafts, aerospace equipment, submersible repeaters, nuclear reactor control systems, life support systems or medical equipment for life support, etc.

The quality grade of NEC devices is "Standard" unless otherwise specified in NEC's Data Sheets or Data Books. If customers intend to use NEC devices for applications other than those specified for Standard quality grade, they should contact an NEC sales representative in advance.

Anti-radioactive design is not implemented in this product.