

Adjustable Precision shunt Regulator

■ Features

- Precision reference voltage
 - CP431 : 2.495V \pm 1%
 - CP431A : 2.495V \pm 0.5%
- Sink current capability: 200mA
- Minimum cathode current for regulation: 300 μ A
- Equivalent full-range temp. coefficient: 30 ppm/ $^{\circ}$ C
- Fast turn-on response
- Low dynamic output impedance: 0.2 Ω
- Programmable output voltage to 36v
- Low output noise.
- Packages: TO92,SOT23

■ Description

The CP431/CP431A are 3-terminal adjustable precision shunt regulators with guaranteed temperature stability over the applicable extended commercial temperature range. The output voltage may be set at any level greater than 2.495V(V_{REF}) up to 36V merely by selecting two external resistors that act as a voltage divider network. These devices have a typical output impedance of 0.2 Ω . Active output circuitry provides a very sharp turn-on characteristics, making these devices excellent improved replacements for Zener diodes in many applications. The precise (+/-) 1% Reference voltage tolerance of the AP431/431A make it possible in many applications to avoid the use of a variable resistor, consequently saving cost and eliminating drift and reliability problems associated with it.

■ Typical Application Circuit

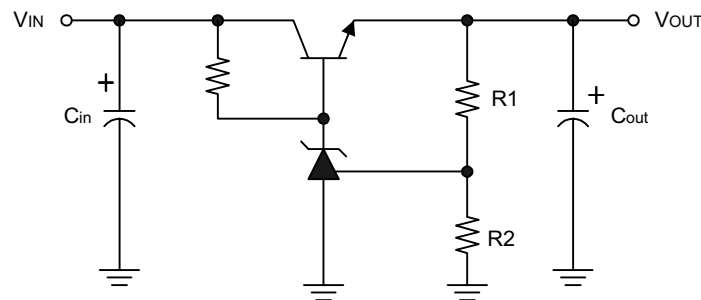

$$V_{OUT} = (1 + R1/R2)V_{REF}$$

Precision Regulator

* All specs and applications shown above subject to change without prior notice.

Adjustable Precision shunt Regulator

■ Block Diagram

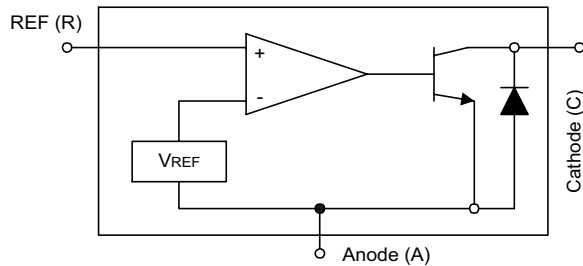

■ Symbol

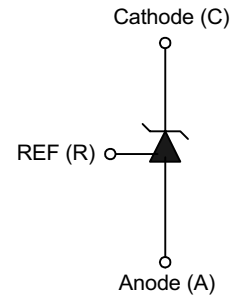

■ Pin Configuration

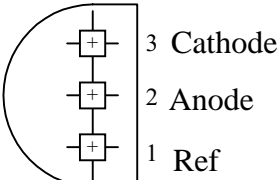
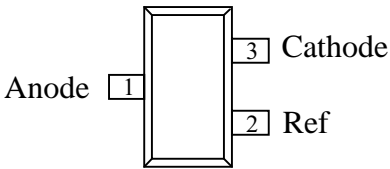
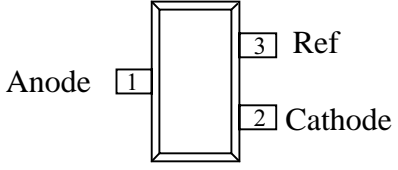
Order Number	Pin Configuration (Top View)
CP431V CP431AV (TO-92)	
CP431W CP431AW (SOT-23)	
CP431R CP431AR (SOT-23)	

* All specs and applications shown above subject to change without prior notice.

Adjustable Precision shunt Regulator

■ Absolute Maximum Ratings

Cathode Voltage	36V
Continuous Cathode Current	-10mA ~ 150mA
Reference Input Current Range	10mA
Operating Temperature Range	0°C ~ 70°C
Lead Temperature.....	260°C
Storage Temperature	-65°C ~ 150°C
Power Dissipation	
TO-92 Package	0.78W
SOT-23 package	0.23W

■ Electrical Characteristics (Ta=25°C , unless otherwise specified.)

PARAMETER	TEST CONDITIONS	SYMBOL	MIN.	TYP.	MAX.	UNIT
Reference voltage	V _{KA} = V _{REF} , I _{KA} = 10mA (Fig.1)	CP431	2.470	2.495	2.520	V
		CP431A	2.482		2.507	
Deviation of Reference input voltage over temperature (Note 3)	V _{KA} = V _{REF} , I _{KA} = 10mA , Ta = 0°C ~ + 70°C	V _{REF}		8.0	20	mV
Ratio of the change in Reference voltage to the change in Cathode voltage	I _{KA} = 10mA (Fig.2)	V _{KA} = 10V ~ V _{REF}	$\frac{\Delta V_{REF}}{\Delta V_{KA}}$	-1.4	-2.0	mV/V
		V _{KA} = 36V ~ 10V	$\frac{\Delta V_{REF}}{\Delta V_{KA}}$	-1	-2	mV/V
Reference input current	R1 = 10KΩ, R2 = ∞ I _{KA} = 10mA	I _{REF}		1.4	3.5	μA
Deviation of Reference input current over temperature	R1 = 10KΩ, R2 = ∞ I _{KA} = 10mA Ta = Full range	α I _{REF}		0.4	1.2	μA
Minimum Cathode current for regulation	V _{KA} = V _{REF} (Fig.1)	I _{KA(MIN)}		0.19	0.5	mA
Off-state current	V _{KA} = 36V, V _{REF} = 0V	I _{KA(OFF)}		0.1	1.0	μA
Dynamic output impedance	V _{KA} = V _{REF} V _{KA} = V _{REF} ΔI _{KA} = 1mA ~ 100mA Frequency ≤ 1KHz (Fig.1)	Z _{KA}		0.2	0.5	Ω

* All specs and applications shown above subject to change without prior notice.

Adjustable Precision shunt Regulator

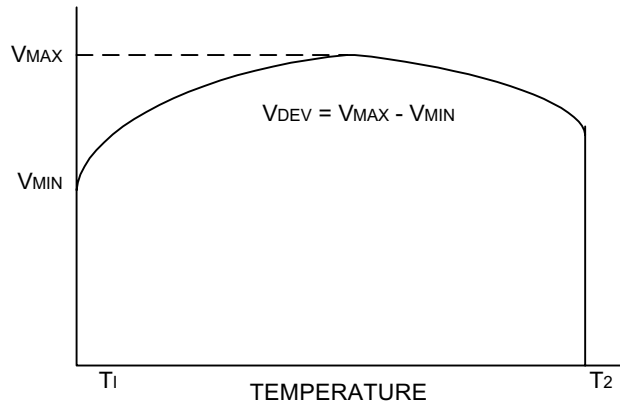

Note . Deviation of reference input voltage, V_{DEV} , is defined as the maximum variation of the reference over the full temperature range.

The average temperature coefficient of the reference input voltage αV_{REF} is defined as:

$$|\alpha V_{REF}| = \frac{\left(\frac{V_{DEV}}{V_{REF}(25^{\circ}\text{C})}\right) \cdot 10^6}{T_2 - T_1} \dots\dots\dots (\text{ppm}/^{\circ}\text{C})$$

Where:

$T_2 - T_1$ = full temperature change.

αV_{REF} can be positive or negative depending on whether the slope is positive or negative.

Note 4. The dynamic output impedance, R_Z , is defined as:

$$|Z_{KA}| = \frac{\Delta V_{KA}}{\Delta I_{KA}}$$

When the device is programmed with two external resistors R_1 and R_2 (see Figure 2.), the dynamic output impedance of the overall circuit, is defined as:

$$|Z_{KA}'| = \frac{\Delta v}{\Delta i} \approx |Z_{KA}| \cdot \left(1 + \frac{R_1}{R_2}\right)$$

■ Test Circuits

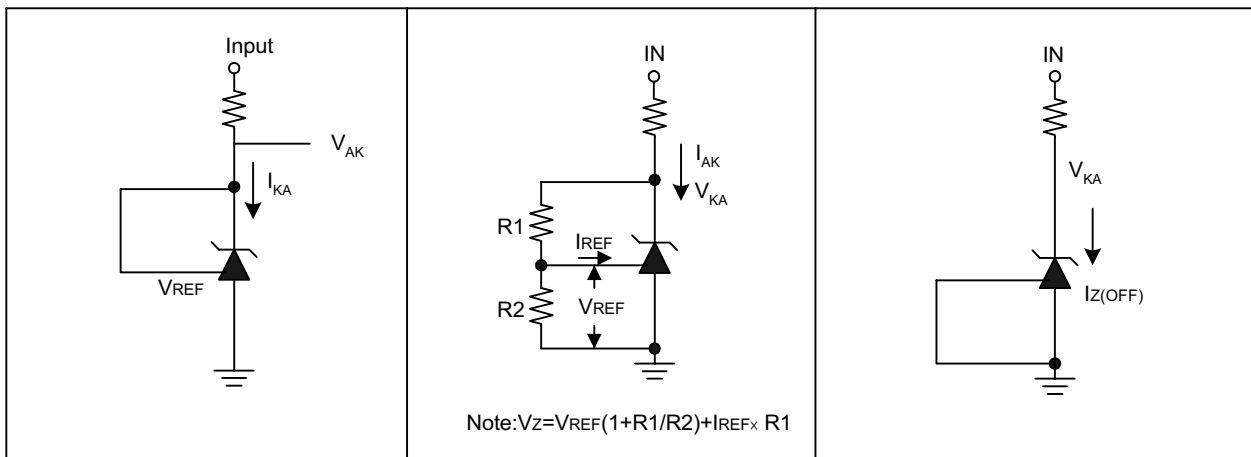

Test Circuit for $V_{KA} = V_{REF}$

Test circuit for $V_{KA} > V_{REF}$

Test Circuit for off-state Current

* All specs and applications shown above subject to change without prior notice.

Adjustable Precision shunt Regulator

■ Typical Performance Characteristics

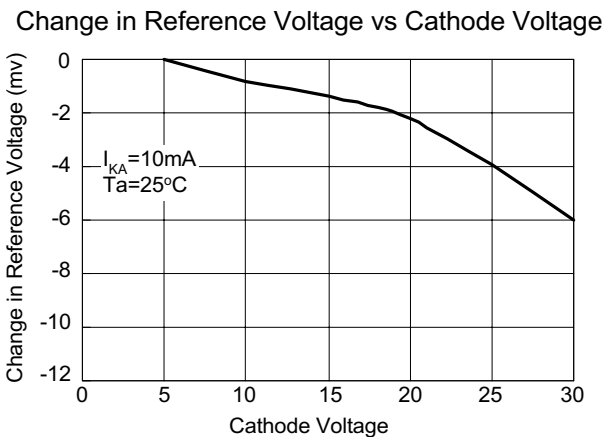
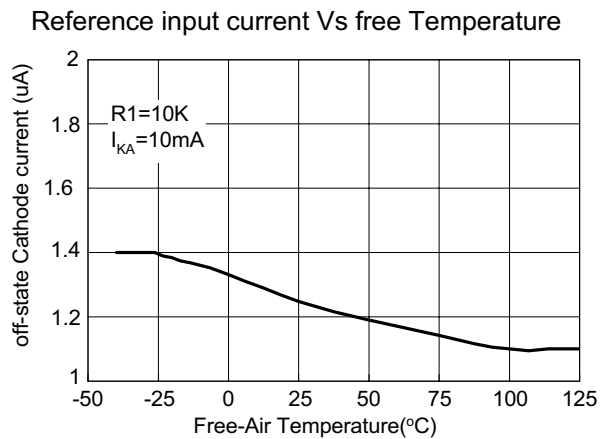
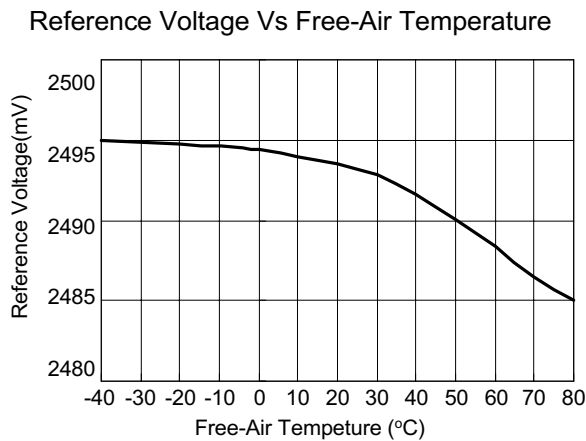
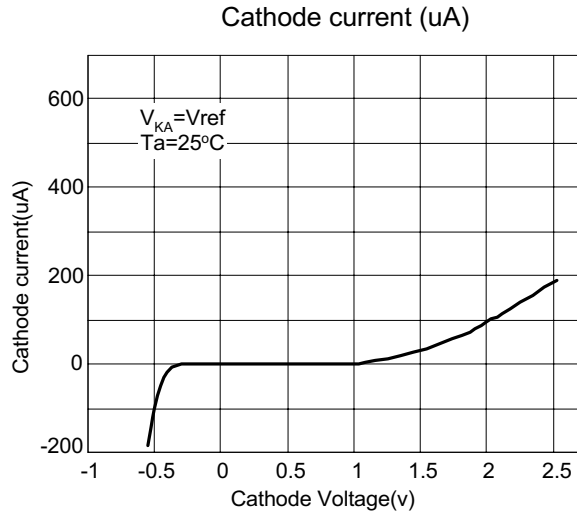
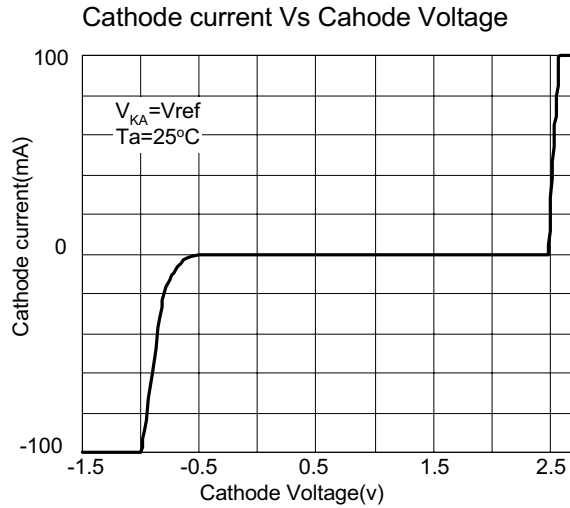

* All specs and applications shown above subject to change without prior notice.

Adjustable Precision shunt Regulator

Application Examples

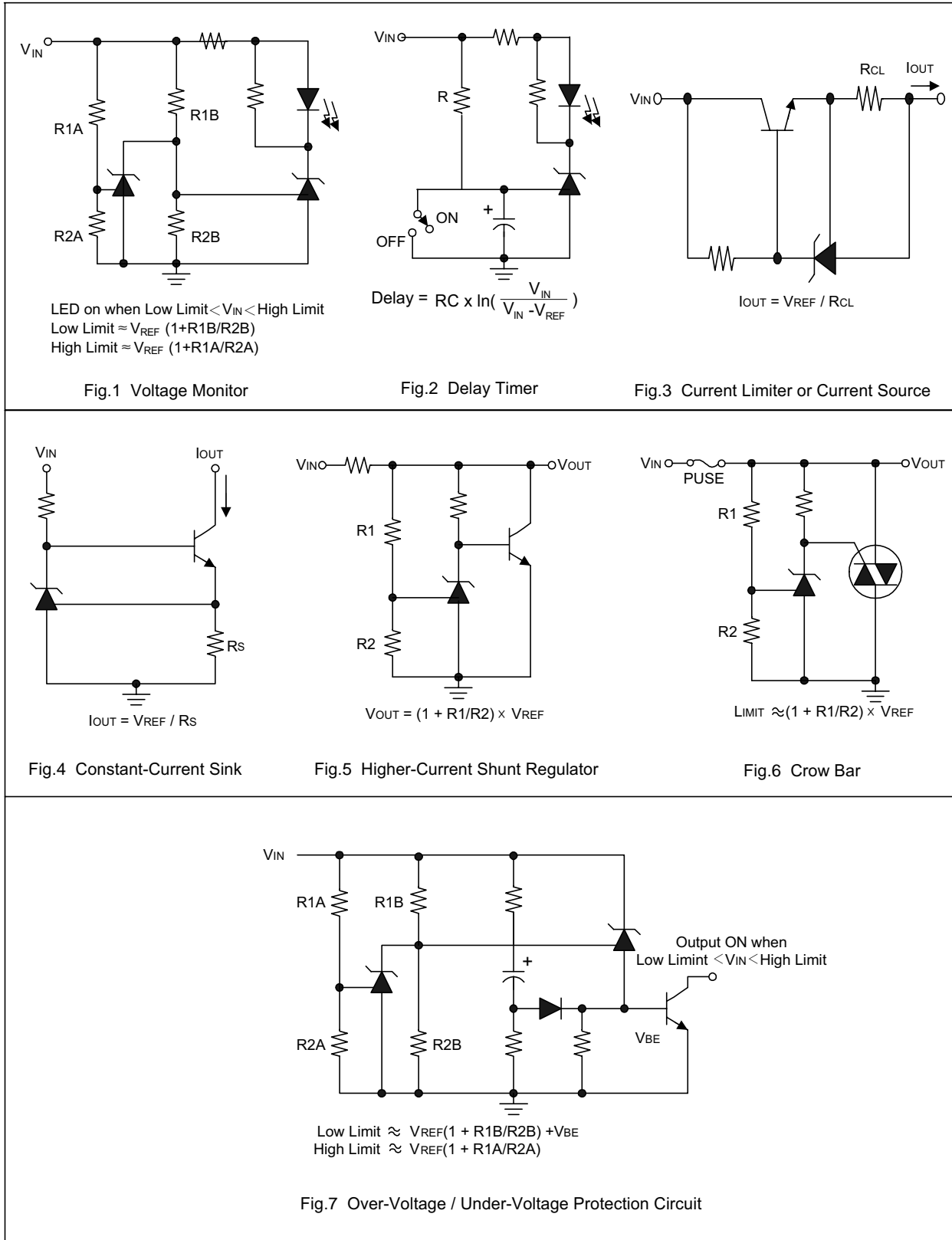

* All specs and applications shown above subject to change without prior notice.

Adjustable Precision shunt Regulator

Taping Specifications For TO-92 package

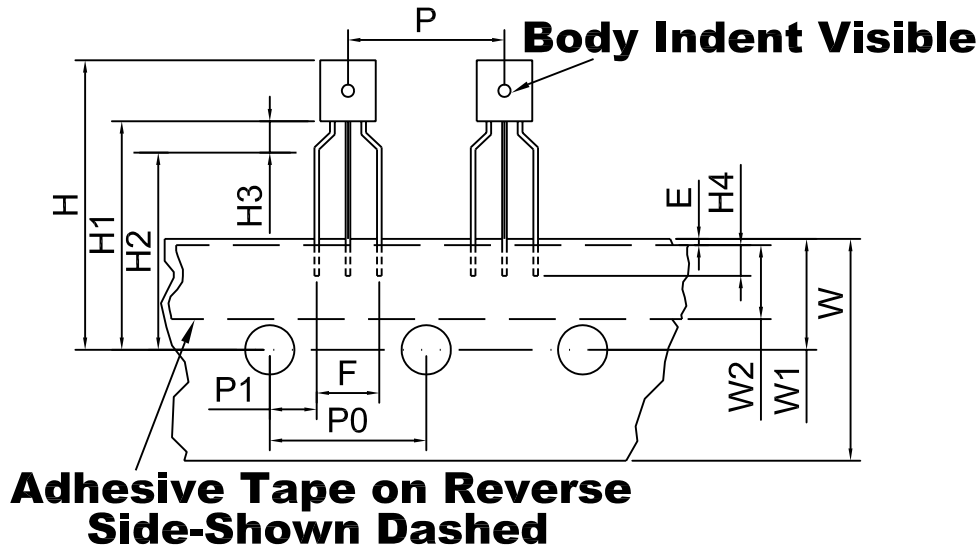

SYMBOL	SPECIFICATIONS (mm)	SPECIFICATIONS (inch)
P	12.7 ± 1.0	0.50 ± 0.07
P0	12.7 ± 1.0	0.50 ± 0.07
P1	3.81 ± 0.4	0.15 ± 0.016
H	21.0~26.0	0.828~1.024
H1	17.0~21.0	0.669~0.828
H2	14.0~18.0	0.551~0.709
H3	3.4 max.	0.125 max.
H4	2.5 min.	0.098 min.
F	5.08 ± 0.2	0.2 ± 0.008
W	18.0 ± 0.5	0.708 ± 0.020
W1	9.0 ± 0.5	0.354 ± 0.020
W2	6.0 ± 0.5	0.236 ± 0.020
ΦD0	4.0 ± 0.2	0.157 ± 0.008
E	0.5 max.	0.020 max.

* All specs and applications shown above subject to change without prior notice.