

INFRARED REMOTE CONTROL RECEIVER

■ GENERAL DESCRIPTION

NJL60H/V000 series are small and high performance receiving devices for infrared remote control system. Comparing with the previous version, NJL50 series, the characteristic for inverter fluorescent lamp noise is improved. The pulse width of NJL60H/V000 series are stable relating to commander's power or distance between transmitter and receiver. NJL60H/V000 series have five kinds of package including three types of metal case to meet the various applications.

■ FEATURES

1. Mold type and metal case type to meet the design of front panel.
2. Elliptic lens to improve the characteristic against light noise from the upper and lower side.
3. Line-up for various center carrier frequencies.

■ APPLICATIONS

1. AV instruments such as Audio, TV, VCR, CD, MD, etc.
2. Home appliances such as Air-conditioner, Fan, etc.
3. The other equipments with wireless remote control.

■ LINE-UP

Mold/ Metal Case	Mold Type		Metal Case Type		
	Top	Side	Top		
View					
Height					
Carrier Frequency	5.4 mm	6.3 mm	8 mm	11 mm	15 mm
fo=30 KHz	NJL61H300	NJL61V300	NJL62H300	NJL63H300	NJL64H300
32.75KHz	NJL61H328	NJL61V328	NJL62H328	NJL63H328	NJL64H328
36 KHz	NJL61H360	NJL61V360	NJL62H360	NJL63H360	NJL64H360
36.7 KHz	NJL61H367	NJL61V367	NJL62H367	NJL63H367	NJL64H367
38 KHz	NJL61H380	NJL61V380	NJL62H380	NJL63H380	NJL64H380
40 KHz	NJL61H400	NJL61V400	NJL62H400	NJL63H400	NJL64H400
56.8 KHz	NJL61H568	NJL61V568	NJL62H568	NJL63H568	NJL64H568

※ Regarding the other frequencies or packages, please contact to New JRC individually.

■ BLOCK DIAGRAM

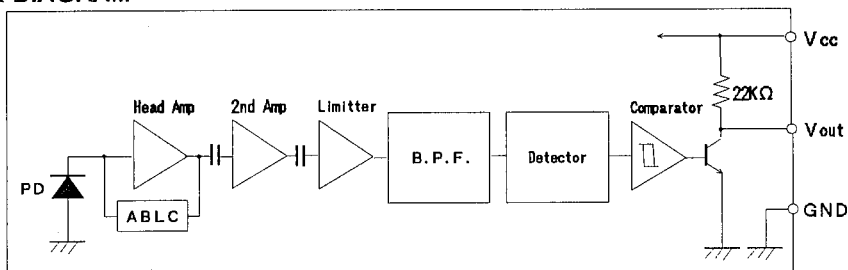

■ ABSOLUTE MAXIMUM RATINGS (Ta= 25 °C)

Supply Voltage	V _{cc}	6.3V
Operating Temperature Range	T _{opr}	-30 °C — +85 °C
Storage Temperature Range	T _{stg}	-40 °C — +85 °C
Soldering Temperature	T _{sol}	260 °C 5sec 4.0mm from mold body

NJL61H/61V/62H/63H/64H000

RECOMMENDED OPERATING CONDITION

Supply Voltage Range V_{cc} 4.5V – 5.5V

ELECTRO-OPTICAL CHARACTERISTICS ($V_{cc} = 5.0V$, $T_a = 25^\circ C$)

PARAMETER	SYMBOL	TEST CONDITION	MIN	TYP	MAX	UNIT
Supply Current	I_{cc}	No Signal Input	—	—	3	mA
Transmission Distance	L_c	Direction of Ray Axis *1	8	16	—	m
Directivity	θ_L	Angle of half L_c , Horizontal *2	—	50	—	deg
	θ_V	Angle of half L_c , Vertical *2	—	35	—	deg
Output Voltage Low	V_L	No Load	—	0.2	0.5	V
Output Voltage High	V_H	No Load	4.5	—	—	V
Low Level Pulse Width	T_{WL}	See Test Circuit	400	—	800	μs
High Level Pulse Width	T_{WH}	See Test Circuit	400	—	800	μs
Center Frequency	f_o	See Line-up	30.0	—	56.8	KHz

Note *1: Test with each center carrier frequency under the test condition shown below.

*2: Place major axis of elliptic lens in horizontal direction and minor in vertical.

TEST METHOD

Test condition is as follows:

(1) Standard Transmitter:

Transmitting waveform is shown in Fig.1. Transmitting power should be adjusted so that output voltage V_{out} will be 400 mVp-p.

Regarding IR LED used for transmitter,
 $\lambda_p = 940nm$, $\Delta \lambda = 50nm$.

Regarding photo diode, Sensitivity
 $S = 26nA/Lx$, in case light source
 temperature 2856 °K, $E_e = 100Lx$, $VR = 5V$

(2) Test system: Shown in Fig.3.

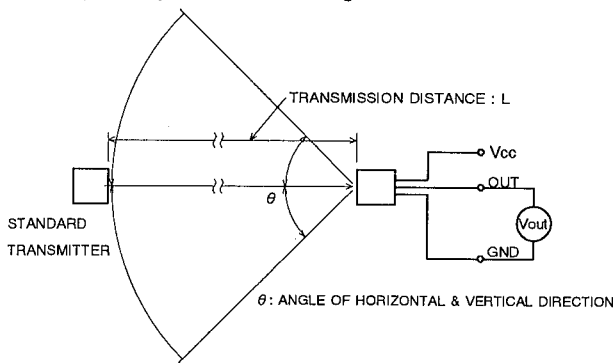

Fig. 3 TEST SYSTEM

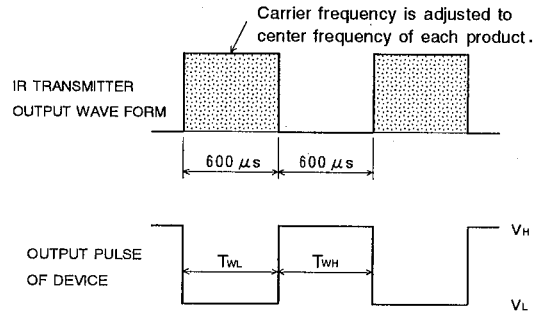

Fig. 1 TRANSMITTER WAVE FORM

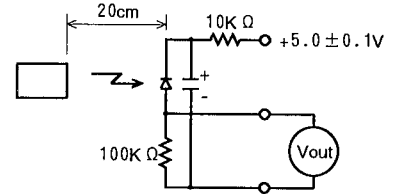
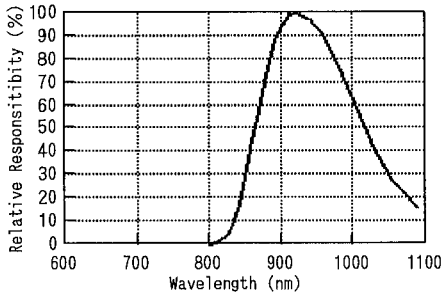

Fig. 2 STD. TRANSMITTER TEST CIRCUIT

■ TYPICAL CHARACTERISTICS

Spectral Response
($T_a=25^\circ\text{C}$)



Directivity
($T_a=25^\circ\text{C}$)

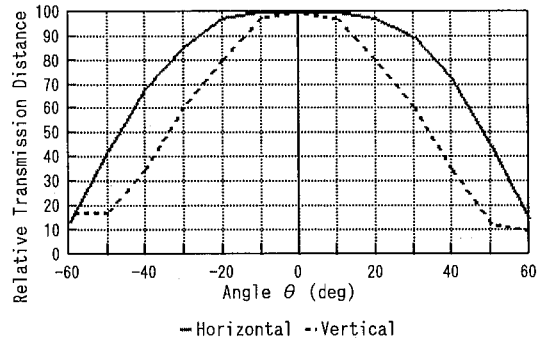

Output Pulse Width vs. Distance
(Input Pulse Width = $600\mu\text{s}$, $V_{cc}=5.0\text{V}$, $T_a=25^\circ\text{C}$)

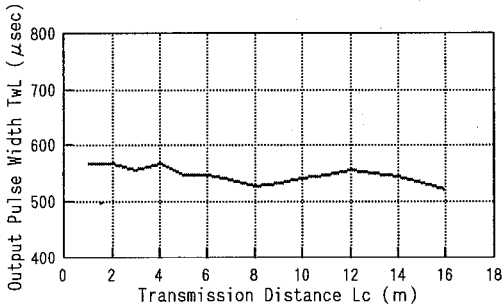

Transmission Distance vs. Supply Voltage
($T_a=25^\circ\text{C}$)

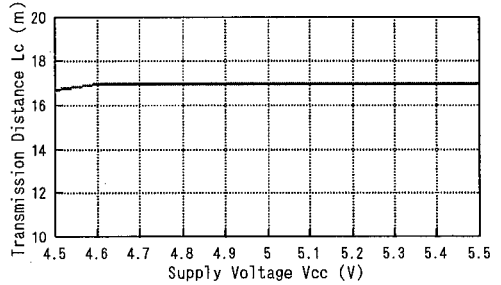

Transmission Distance vs. Carrier Frequency
($V_{cc}=5.0\text{V}$, $T_a=25^\circ\text{C}$)

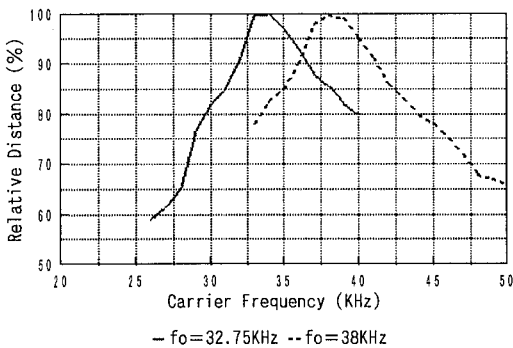

Transmission Distance vs. Temperature
($V_{cc}=5.0\text{V}$)

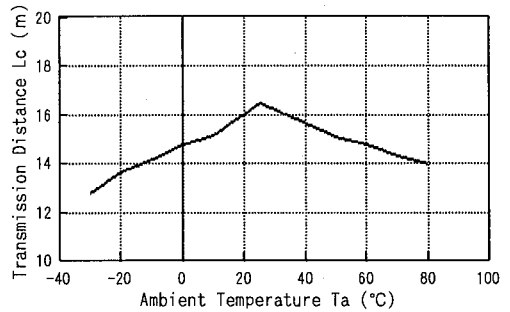

3

NJL61H/61V/62H/63H/64H000

RECOMMENDED APPLICATION CIRCUIT

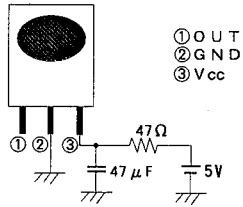

RC Filter should be connected closely between Vcc pin and GND pin.

OUTLINE

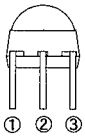
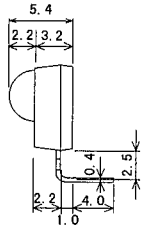
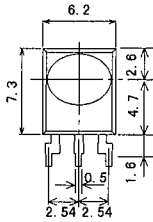

NJL61H000
UNIT : mm

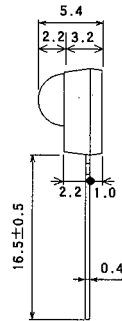
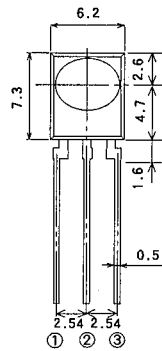

NJL61V000
UNIT : mm

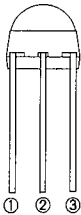
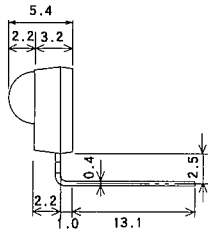
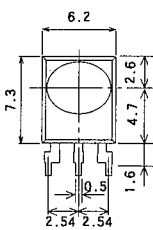

NJL61H000F3
UNIT : mm



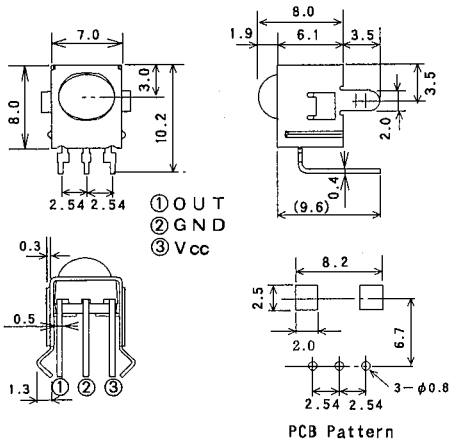

NJL62H000
UNIT : mm

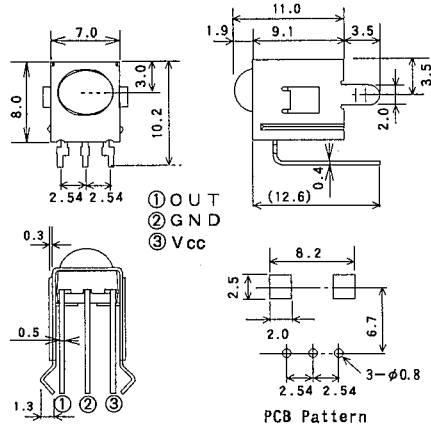

NJL63H000
UNIT : mm

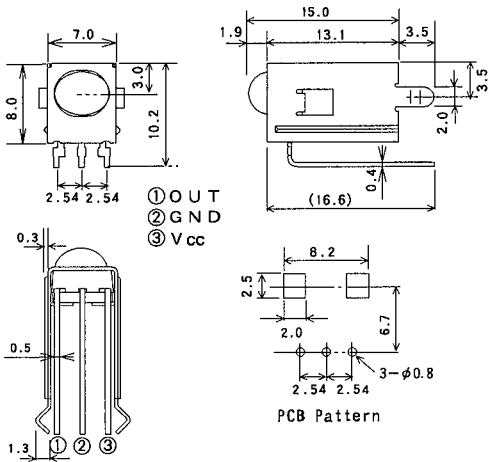

NJL64H000
UNIT : mm

1. Tolerance is $\pm 0.3\text{mm}$ unless otherwise noted.
2. Ground metal case on PCB. Metal case is not connected to GND pin inside.

NJL61H/61V/62H/63H/64H000

MEMO

[CAUTION]

The specifications on this databook are only given for information, without any guarantee as regards either mistakes or omissions. The application circuits in this databook are described only to show representative usages of the product and not intended for the guarantee or permission of any right including the industrial rights.