

MC623

3.0 V, Dual Trip Point Temperature Sensor

The MC623 is a 3.0 V solid-state, programmable temperature sensor designed for use in thermal management applications. It features dual thermal interrupt outputs (LOW LIMIT and HIGH LIMIT) each of which program with a single external resistor. The HIGH LIMIT and LOW LIMIT outputs are driven active (high) when measured temperature exceeds the user-programmed limits. The CONTROL output is driven active (high) when temperature exceeds the HIGH LIMIT setpoint, and turned off when temperature falls below the LOW LIMIT setpoint. The CONTROL output can be used to provide simple ON/OFF control to a cooling fan if so desired.

Low voltage operation, easy setpoint programming, small size and low cost make the MC623 an ideal choice for many thermal management applications.

Features

- Integrated Temperature Sensor and Detector Operate from a Supply Voltage as Low as 2.7 V
- Replaces Mechanical Thermostats and Switches
- On-Chip Temperature Sense
- 8-Pin SOIC for Direct PCB Mounting
- 2 User-Programmable Temperature Set Points
- 2 Independent Temperature Limit Outputs
- Heat/Cool Regulate Output
- Operating Temperature Range: -40°C to +85°C

Typical Applications

- CPU Thermal Management
- System Over-or Under-Temperature Shutdown
- Advanced Thermal Warning
- Fan Speed Control Circuits
- Accurate Appliance Temperature Sensing
- Environmental Control



ON Semiconductor®

<http://onsemi.com>

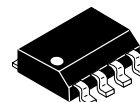

SO-8
D SUFFIX
CASE TBD

PRELIMINARY INFORMATION

PIN CONFIGURATION

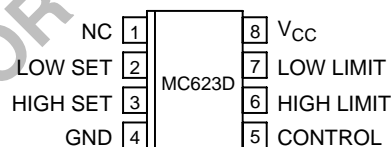

(Top View)

ORDERING INFORMATION

Device	Package	Shipping
MC623DR2	8-Pin SOIC	2500 Tape/Reel

MC623

FUNCTIONAL BLOCK DIAGRAM

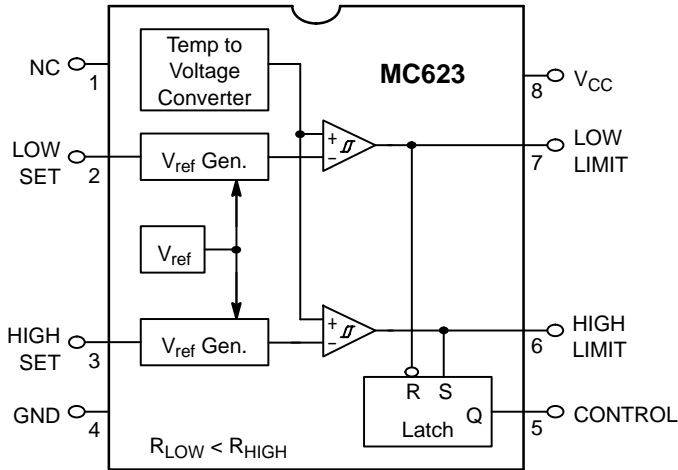

MAXIMUM RATINGS*

Rating	Value	Unit
Package Power Dissipation ($T_A \leq 70^\circ\text{C}$)	470	mW
Derating Factors	6.0	mW/ $^\circ\text{C}$
Supply Voltage	5.5	V
Input Voltage, Any Input	(GND - 0.3) to ($V_{DD} + 0.3$)	V
Operating Temperature Range	-40 to +125	$^\circ\text{C}$
Maximum Chip Temperature	150	$^\circ\text{C}$
Storage Temperature Range	-65 to +150	$^\circ\text{C}$
Lead Temperature (Soldering, 10 Seconds)	+300	$^\circ\text{C}$

* Maximum Ratings are those values beyond which damage to the device may occur.

ELECTRICAL CHARACTERISTICS (Over Operating Temperature Range, $V_{DD} = 2.7\text{V}$ to 4.5V , unless otherwise noted.)

Characteristic	Symbol	Min	Typ ¹	Max	Unit
Supply Voltage Range	V_{DD}	2.7	-	4.5	V
Supply Current ($2.7\text{V} \leq V_{DD} \leq 4.5\text{V}$)	I_{DD}	-	150	250	μA
Absolute Accuracy T = Programmed Temperature		T-3	$T \pm 1$	T+3	$^\circ\text{C}$
$I_{OH} = 250\mu\text{A}$ $I_{OH} = 500\mu\text{A}$	V_{OH}	$0.9 \times V_{DD}$ $0.8 \times V_{DD}$	-	-	V
$I_{OL} = 500\mu\text{A}$ $I_{OL} = 1.0\text{mA}$	V_{OL}	-	-	$0.1 \times V_{DD}$ $0.2 \times V_{DD}$	V
Hysteresis (Falling Temperature)	HYST	-	-	-2.0	$^\circ\text{C}$

1. Measured at 25°C .

DETAILED DESCRIPTION

MC623 Operation

The MC623 consists of a positive temperature coefficient (PTC) temperature sensor and dual threshold detector. Temperature set point programming is easily accomplished with external programming resistors from the HIGH SET and LOW SET inputs to V_{CC}. The HIGH LIMIT and LOW LIMIT outputs remain inactive (low) as long as the measured temperature is below setpoint values. As temperature increases, the LOW LIMIT is driven high when temperature exceeds the LOW LIMIT setpoint (±3°C). If temperature continues to climb, the HIGH LIMIT output is driven high when temperature exceeds the HIGH LIMIT setpoint (±3°C). Figure 1 shows the relationship between the sense resistance values and trip point temperature.

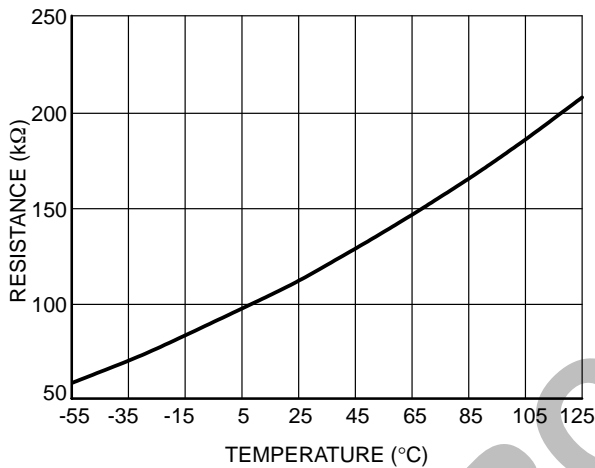

Figure 1. MC623 Sense Resistors vs. Trip Temperature

The CONTROL output is driven high when the HIGH LIMIT output goes high, and is reset low when the LOW LIMIT output goes low. This output provides the logic for simple ON/OFF fan control. Figure 2 shows overall MC623 operation.

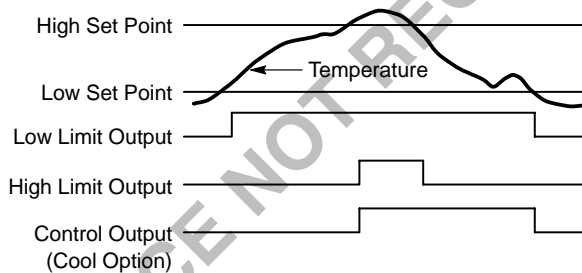

Figure 2. MC623 Temperature vs. Output

To prevent output "chattering" when measured temperature is at (or near) the programmed trip point values, the LOW SET and HIGH SET inputs each have a built-in hysteresis of - 2°C max. As a result, the HIGH LIMIT and LOW LIMIT outputs remain active until the measured temperature falls a maximum of 2°C below the programmed HIGH SET and LOW SET thresholds as shown in Figure 3. The *programmed setting* threshold of Figure 3 is user-programmed temperature trip points of either the LOW SET or HIGH SET inputs. The LOW LIMIT or HIGH LIMIT output is driven active when temperature equals the programmed setpoint value (to within 3°C). The output *remains* active until the temperature falls an additional 2°C below the setpoint due to hysteresis.

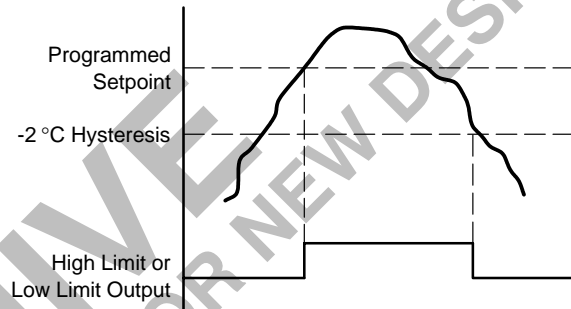

Figure 3. High Set and Low Set Thresholds

APPLICATIONS

Mounting

If the MC623 is used to measure the temperature of another device, it is important that the top surface of the MC623 package be in intimate contact with the measured device. Good thermal conductivity and no air space is critical to accurate temperature measurement in applications of this type.

Trip Point Programming

The resistance values required for the HIGH SET and LOW SET inputs are calculated using the formula below:

$$R_{TRIP} = 0.5997 \times T^{2.1312}$$

Where R_{trip} = Programming resistor value in Ohms

T = Desired trip temperature in degrees Kelvin.

For example, to program a trip point of 50°C, the programming resistor is:

$$R_{TRIP} = 0.5997 \times (50 + 273.15)^{2.1312} = 133,652 \Omega$$

MC623

PACKAGE DIMENSIONS

8-Pin SOIC
PLASTIC PACKAGE
CASE TBD
ISSUE TBD

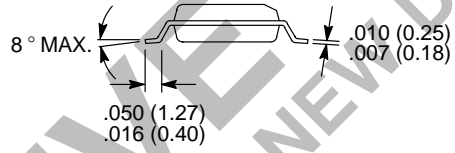
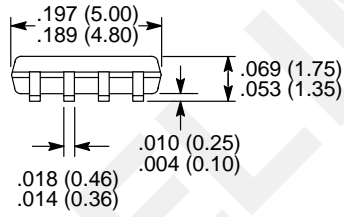
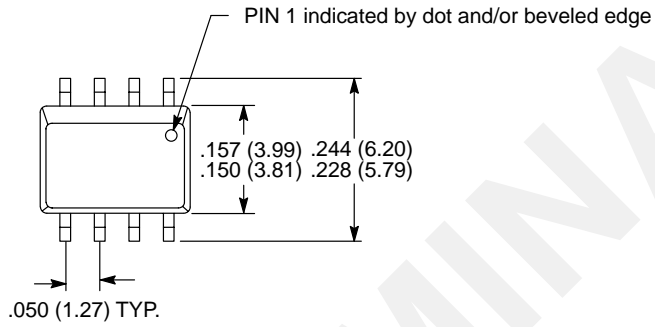

Dimensions: inches (mm)

PRELIMINARY
ARCHIVE
DEVICE NOT RECOMMENDED FOR NEW DESIGN

ARCHIVE
RECOMMENDED FOR NEW DESIGN

ON Semiconductor and  are registered trademarks of Semiconductor Components Industries, LLC (SCILLC). SCILLC reserves the right to make changes without further notice to any products herein. SCILLC makes no warranty, representation or guarantee regarding the suitability of its products for any particular purpose, nor does SCILLC assume any liability arising out of the application or use of any product or circuit, and specifically disclaims any and all liability, including without limitation special, consequential or incidental damages. "Typical" parameters which may be provided in SCILLC data sheets and/or specifications can and do vary in different applications and actual performance may vary over time. All operating parameters, including "Typicals" must be validated for each customer application by customer's technical experts. SCILLC does not convey any license under its patent rights nor the rights of others. SCILLC products are not designed, intended, or authorized for use as components in systems intended for surgical implant into the body, or other applications intended to support or sustain life, or for any other application in which the failure of the SCILLC product could create a situation where personal injury or death may occur. Should Buyer purchase or use SCILLC products for any such unintended or unauthorized application, Buyer shall indemnify and hold SCILLC and its officers, employees, subsidiaries, affiliates, and distributors harmless against all claims, costs, damages, and expenses, and reasonable attorney fees arising out of, directly or indirectly, any claim of personal injury or death associated with such unintended or unauthorized use, even if such claim alleges that SCILLC was negligent regarding the design or manufacture of the part. SCILLC is an Equal Opportunity/Affirmative Action Employer.

PUBLICATION ORDERING INFORMATION

Literature Fulfillment:

Literature Distribution Center for ON Semiconductor
P.O. Box 5163, Denver, Colorado 80217 USA
Phone: 303-675-2175 or 800-344-3860 Toll Free USA/Canada
Fax: 303-675-2176 or 800-344-3867 Toll Free USA/Canada
Email: ONlit@hibbertco.com

N. American Technical Support: 800-282-9855 Toll Free USA/Canada

JAPAN: ON Semiconductor, Japan Customer Focus Center
2-9-1 Kamimeguro, Meguro-ku, Tokyo, Japan 153-0051
Phone: 81-3-5773-3850

ON Semiconductor Website: <http://onsemi.com>

For additional information, please contact your local Sales Representative.