

International IOR Rectifier

18TQ... 18TQ...S

SCHOTTKY RECTIFIER

18 Amp

$I_{F(AV)} = 18\text{Amp}$
 $V_R = 35 \text{ to } 45\text{V}$

Major Ratings and Characteristics

Characteristics	18TQ	Units
$I_{F(AV)}$ Rectangular waveform	18	A
V_{RRM} range	35 to 45	V
I_{FSM} @tp = 5 μ s sine	1800	A
V_F @18 Apk, $T_J = 125^\circ\text{C}$	0.53	V
T_J range	-55 to 175	$^\circ\text{C}$

Description/Features

The 18TQ Schottky rectifier series has been optimized for low reverse leakage at high temperature. The proprietary barrier technology allows for reliable operation up to 175 $^\circ\text{C}$ junction temperature. Typical applications are in switching power supplies, converters, free-wheeling diodes, and reverse battery protection.

- 175 $^\circ\text{C}$ T_J operation
- High purity, high temperature epoxy encapsulation for enhanced mechanical strength and moisture resistance
- Low forward voltage drop
- High frequency operation
- Guard ring for enhanced ruggedness and long term reliability

Case Styles

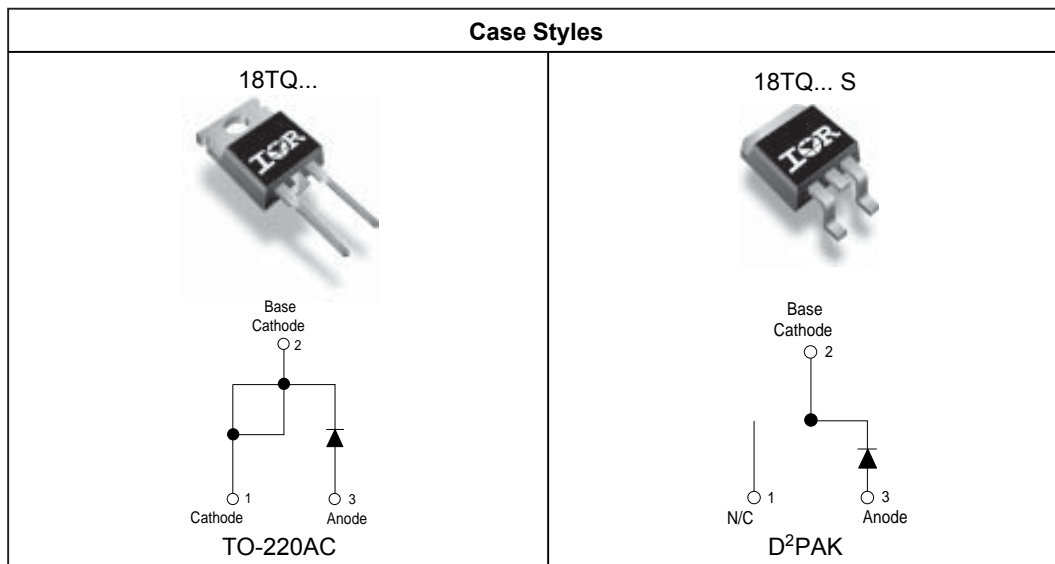

Voltage Ratings

Part number	18TQ035	18TQ040	18TQ045
V_R Max. DC Reverse Voltage (V)	35	40	45
V_{RWM} Max. Working Peak Reverse Voltage (V)			

Absolute Maximum Ratings

Parameters	18TQ	Units	Conditions
$I_{F(AV)}$ Max. Average Forward Current * See Fig. 5	18	A	50% duty cycle @ $T_C = 149^\circ\text{C}$, rectangular wave form
I_{FSM} Max. Peak One Cycle Non-Repetitive Surge Current * See Fig. 7	1800	A	Following any rated load condition and with rated V_{RWM} applied
	390		
E_{AS} Non-Repetitive Avalanche Energy	24	mJ	$T_J = 25^\circ\text{C}$, $I_{AS} = 3.6\text{Amps}$, $L = 3.7\text{mH}$
I_{AR} Repetitive Avalanche Current	3.6	A	Current decaying linearly to zero in 1 μsec Frequency limited by T_J max. $V_A = 1.5 \times V_R$ typical

Electrical Specifications

Parameters	18TQ	Units	Conditions
V_{FM} Max. Forward Voltage Drop (1) * See Fig. 1	0.60	V	@ 18A
	0.72	V	@ 36A
	0.53	V	@ 18A
	0.67	V	@ 36A
I_{RM} Max. Reverse Leakage Current (1) * See Fig. 2	2.5	mA	$T_J = 25^\circ\text{C}$
	25	mA	$T_J = 125^\circ\text{C}$
C_T Max. Junction Capacitance	1400	pF	$V_R = 5V_{DC}$, (test signal range 100Khz to 1Mhz) 25°C
L_S Typical Series Inductance	8.0	nH	Measured lead to lead 5mm from package body
dv/dt Max. Voltage Rate of Change (Rated V_R)	10000	V/ μs	

(1) Pulse Width < 300 μs , Duty Cycle < 2%

Thermal-Mechanical Specifications

Parameters	18TQ	Units	Conditions
T_J Max. Junction Temperature Range	-55 to 175	$^\circ\text{C}$	
T_{stg} Max. Storage Temperature Range	-55 to 175	$^\circ\text{C}$	
R_{thJC} Max. Thermal Resistance Junction to Case	1.50	$^\circ\text{C/W}$	DC operation * See Fig. 4
R_{thCS} Typical Thermal Resistance, Case to Heatsink	0.50	$^\circ\text{C/W}$	Mounting surface, smooth and greased
wt Approximate Weight	2 (0.07)		g (oz.)
T Mounting Torque	Min.	6 (5)	Kg-cm (lbf-in)
	Max.	12 (10)	

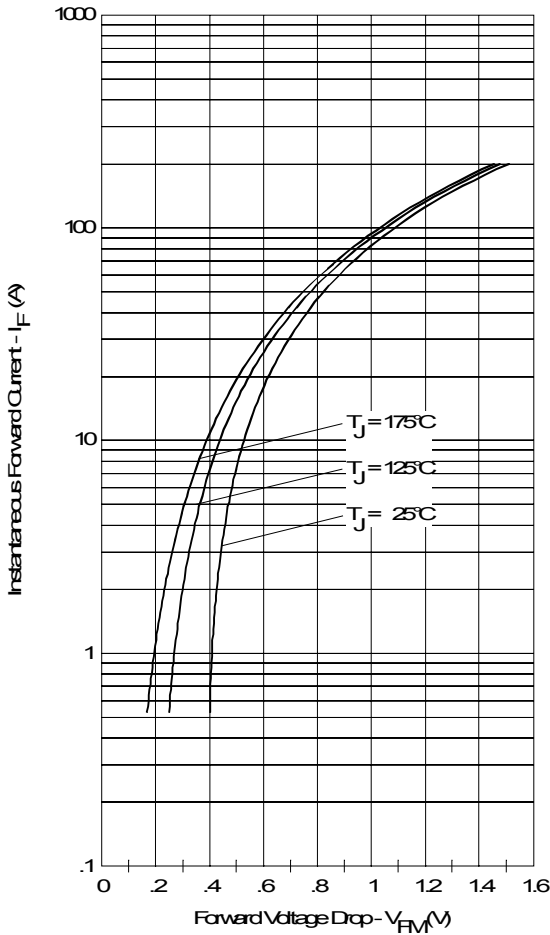

Fig. 1 - Maximum Forward Voltage Drop Characteristics

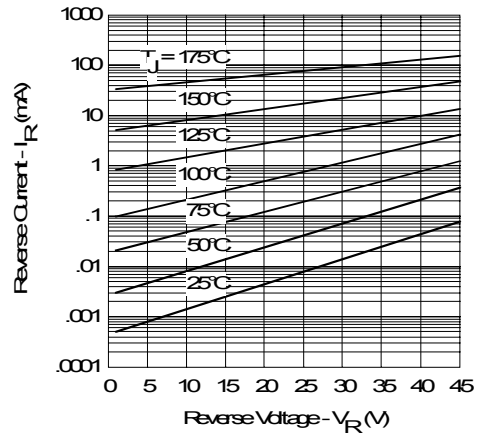

Fig. 2 - Typical Values of Reverse Current Vs. Reverse Voltage

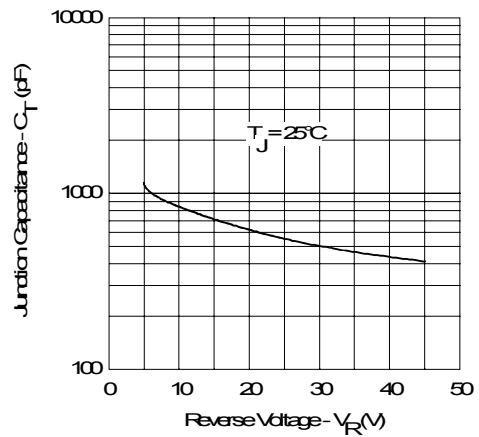

Fig. 3 - Typical Junction Capacitance Vs. Reverse Voltage

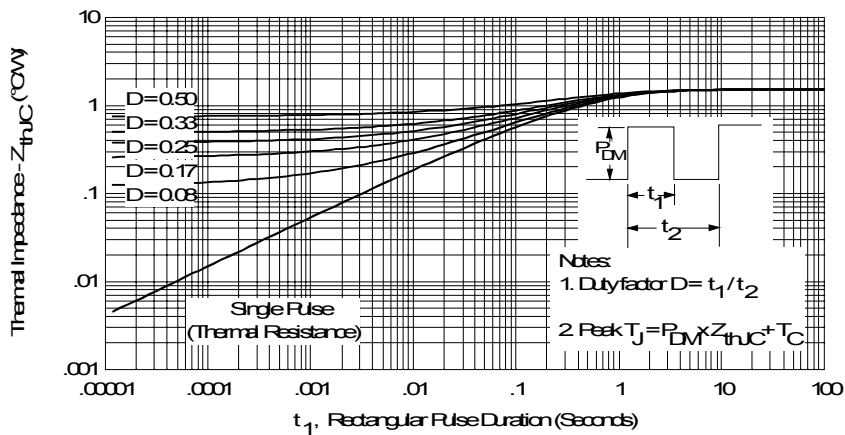

Fig. 4 - Maximum Thermal Impedance Z_{thJC} Characteristics

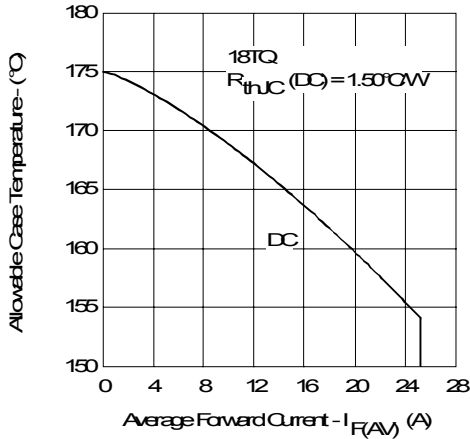

Fig. 5 - Maximum Allowable Case Temperature Vs. Average Forward Current

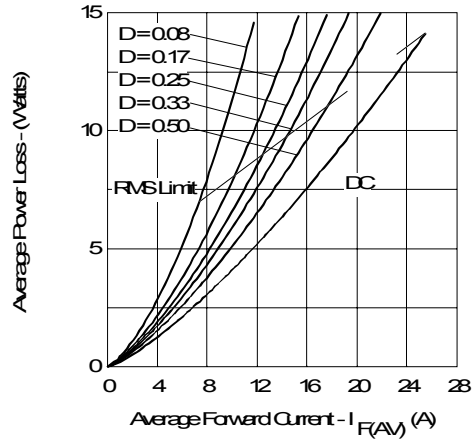

Fig. 6 - Forward Power Loss Characteristics

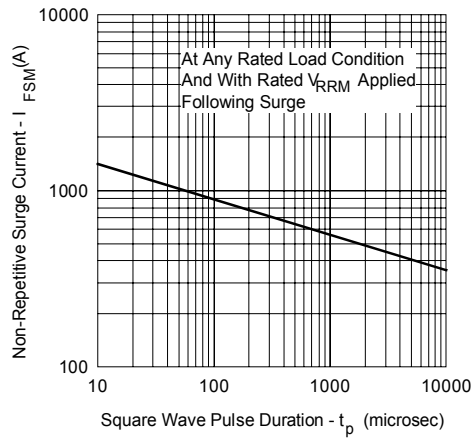

Fig. 7 - Maximum Non-Repetitive Surge Current

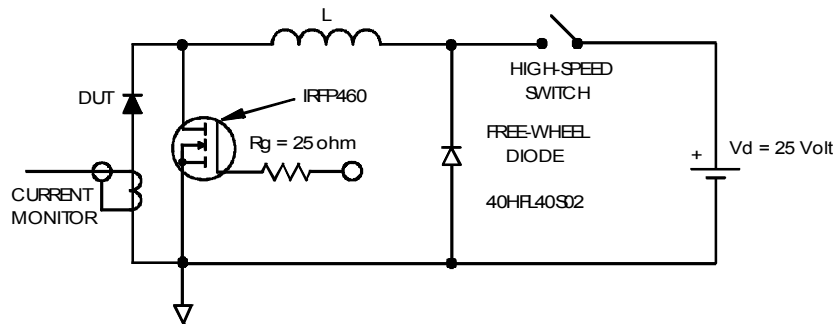
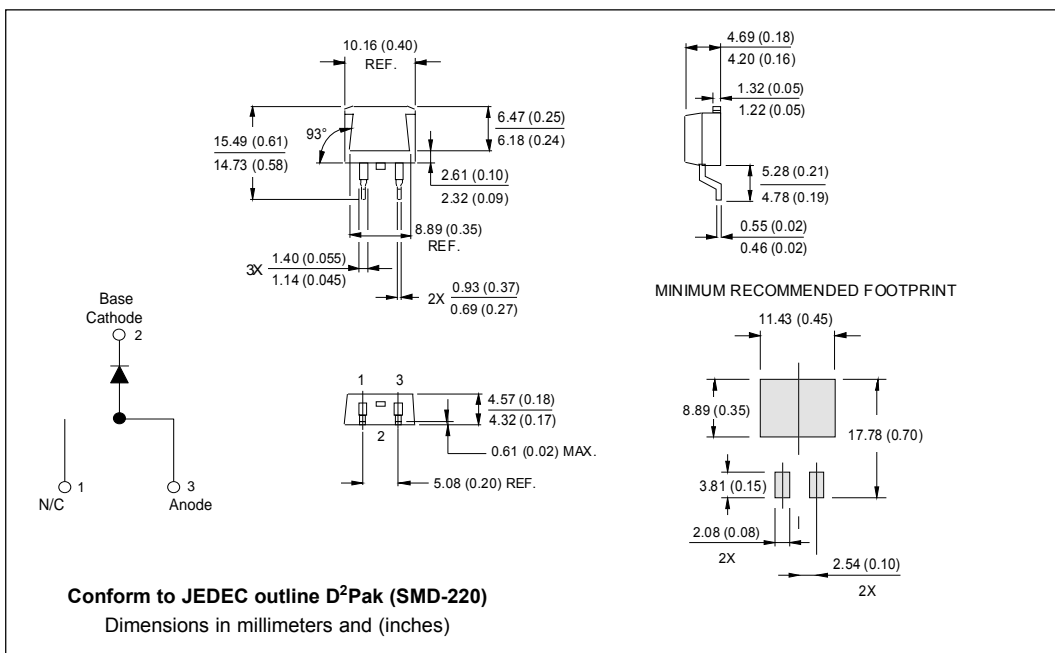
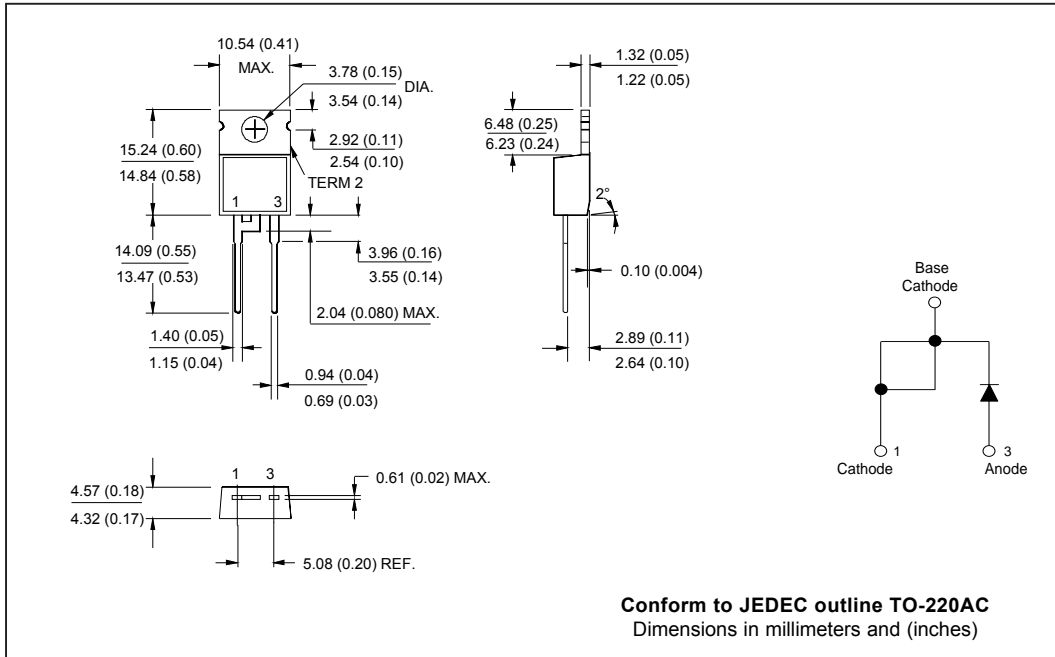
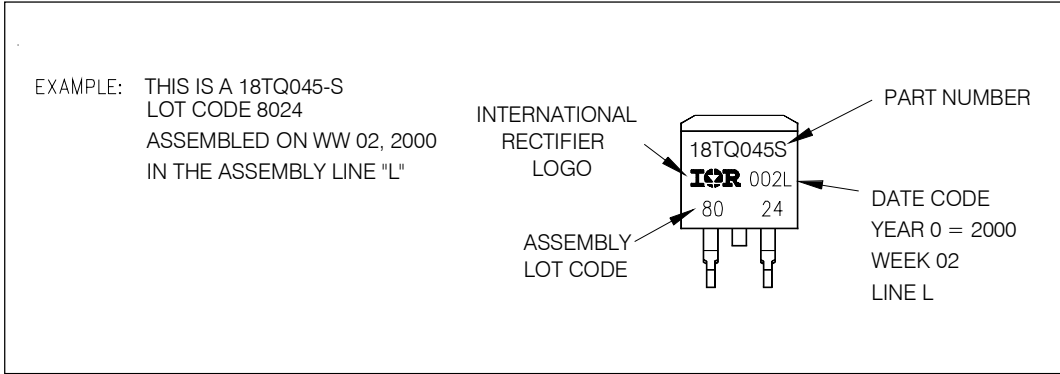

Fig. 8 - Unclamped Inductive Test Circuit

Outline Table



Marking Information



Tape & Reel Information

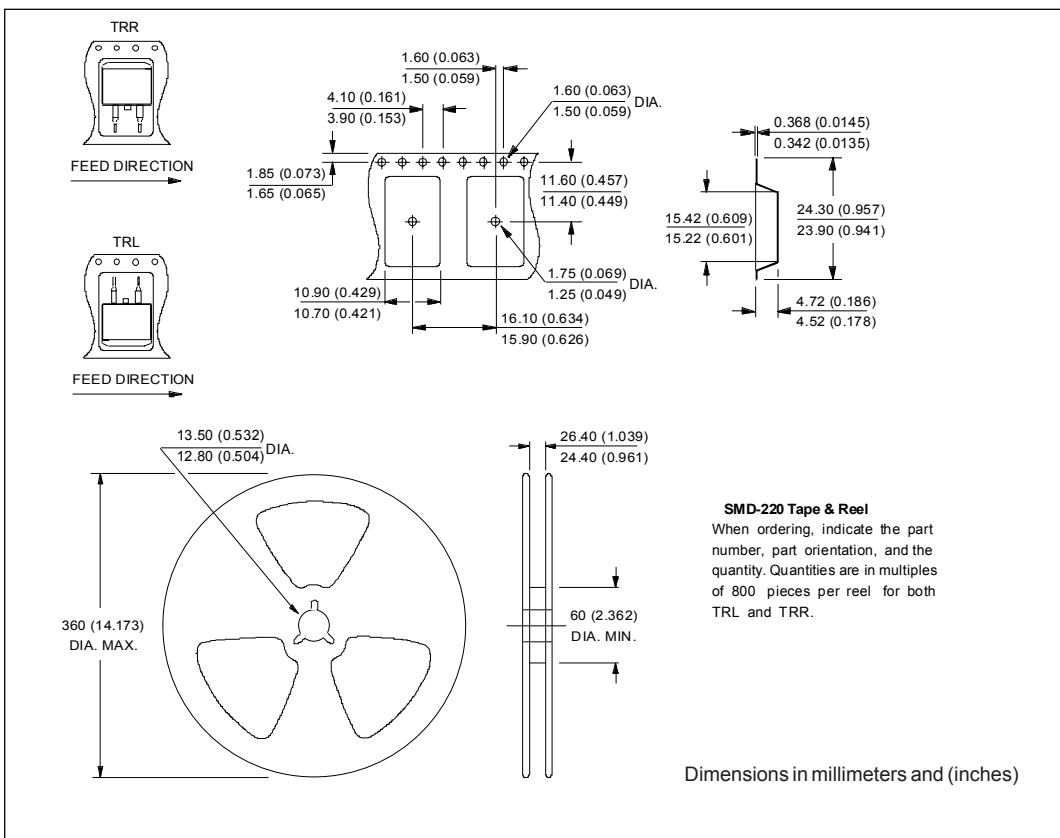

Ordering Information Table

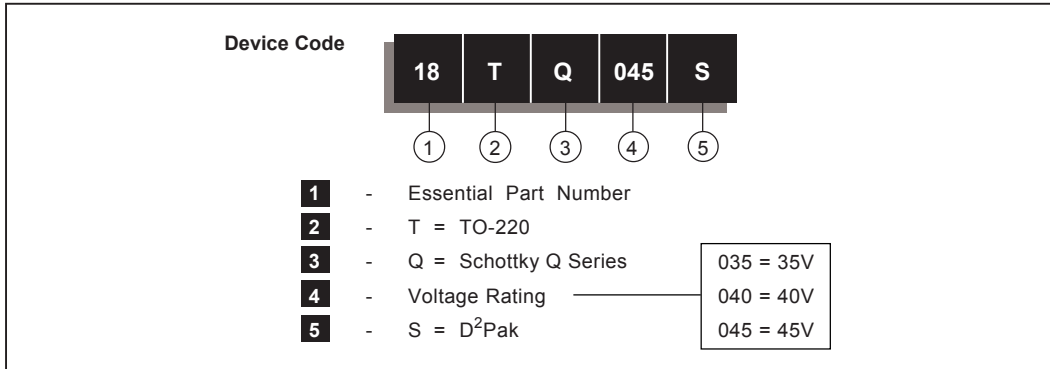

```

18TQ045
*****
* This model has been developed by *
* Wizard SPICE MODEL GENERATOR (1999) *
* (International Rectifier Corporation) *
* Contains Proprietary Information *
*****
* SPICE Model Diode is composed by a *
* simple diode plus paralalled VCG2T *
*****
.SUBCKT 18TQ045 ANO CAT
D1 ANO 1 DMOD (0.10899)
*Define diode model
.MODEL DMOD D(IS=4.49213078685186E-05A,N=1.23149728754907,BV=52V,
+ IBV=9.03115410463162E-02A,RS= 0.000664839,CJO=2.73074429693125E-08,
+ VJ=0.881972575936711,XTI=2, EG=0.789061316955255)
*****
*Implementation of VCG2T
VX 1 2 DC 0V
R1 2 CAT TRES 1E-6
.MODEL TRES RES(R=1,TC1=18.1199792035774)
GP1 ANO CAT VALUE={-ABS(I(VX))*(EXP((((-3.316412E-03/18.11998)*((V(2,CAT)*1E6)/(I(VX)+1E-6)-
1))+1)*6.806625E-02*ABS(V(ANO,CAT))))-1)}
*****
.ENDS 18TQ045

Thermal Model Subcircuit
.SUBCKT 18TQ045 5 1

CTHERM1 5 4 6.49E-01
CTHERM2 4 3 3.46E+00
CTHERM3 3 2 1.63E+01
CTHERM4 2 1 3.01E+02

RTHERM1 5 4 6.77E-01
RTHERM2 4 3 5.70E-01
RTHERM1 3 2 2.05E-01
RTHERM1 2 1 3.44E-02

.ENDS 18TQ045
    
```

18TQ... Series

Bulletin PD-20178 rev. C 07/03

International
IOR Rectifier

Data and specifications subject to change without notice.
This product has been designed and qualified for Industrial Level.
Qualification Standards can be found on IR's Web site.

International
IOR Rectifier

IR WORLD HEADQUARTERS: 233 Kansas St., El Segundo, California 90245, USA Tel: (310) 252-7105
TAC Fax: (310) 252-7309
Visit us at www.irf.com for sales contact information. 07/03