

### FEATURES

<1mV  $V_{OS}$   
 Low Drift  
 80ns Settling to 0.1%; 200ns to 0.01%  
 100mA Output @  $\pm 10V$

### APPLICATIONS

D/A Current Converter  
 Video Pulse Amplifier  
 CRT Deflection Amplifier  
 Wideband Current Booster

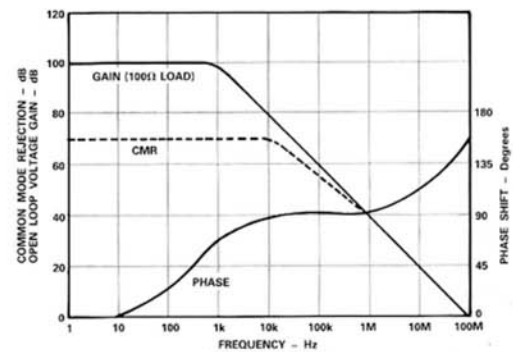
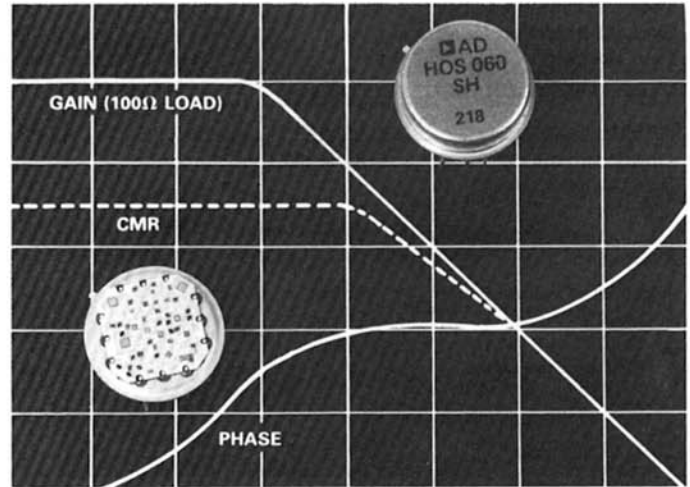

Figure 1. HOS-060 Frequency Response

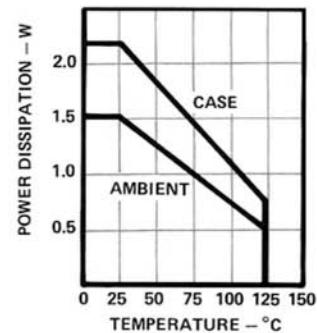

Figure 2. Power Derating

### GENERAL DESCRIPTION

The HOS-060 Operational Amplifier is an extension of the proven hybrid technology used in the HOS-050 series of op amps.

The FET input and high-performance characteristics, including wide bandwidth and fast settling, make it useful for a variety of applications in the processing of video signals.

Recent innovations in circuit design have been incorporated into the HOS-060 to make it extremely useful to the designer who needs outstanding performance in current boosting, voltage amplification, impedance matching, or a multiplicity of other high-frequency requirements.

Voltage offset and its temperature coefficient have been dramatically improved in the HOS-060; offset is as low as on most monolithic op amps, despite being a thick-film hybrid.

These improvements, moreover, have been accomplished without any sacrifice in the other parameters which characterize its outstanding performance in video applications.

The HOS-060 op amp is pin-for-pin compatible with its forerunner HOS-050 and is useable in the same diversity of video requirements. The reader is strongly urged to refer to the six-page data sheet for the HOS-050 op amp to obtain additional insight and details on potential uses for the HOS-060.

The HOS-060 Operational Amplifier is housed in an industry standard TO-8 metal can and operates over a case temperature range of  $-55^{\circ}\text{C}$  to  $+125^{\circ}\text{C}$ ; the model number for the standard unit is HOS-060SH.

For units processed to MIL-STD-883, Method 5008, specify model number HOS-060SH/883.

Information furnished by Analog Devices is believed to be accurate and reliable. However, no responsibility is assumed by Analog Devices for its use; nor for any infringements of patents or other rights of third parties which may result from its use. No license is granted by implication or otherwise under any patent or patent rights of Analog Devices.

Route 1 Industrial Park; P.O. Box 280; Norwood, Mass. 02062  
 Tel: 617/329-4700 TWX: 710/394-6577  
 West Coast Mid-West Texas  
 714/842-1717 312/653-5000 214/231-5094

# SPECIFICATIONS (typical @ +25°C and ±15V unless otherwise specified)

Model	HOS-060SH	HOS-060SH/883
<b>ABSOLUTE MAXIMUM RATINGS</b>		
Supply Voltages ( $V_S$ )	±18V	*
Power Dissipation	See Figure 2	*
Input Voltage	± $V_S$	*
Differential Input Voltage	± $V_S$	*
Operating Temperature Range (case)	-55°C to +125°C	*
Junction Temperature	175°C	*
Storage Temperature Range	-65°C to +150°C	*
Lead Temperature (soldering, 10 sec.)	300°C	*

## DC ELECTRICAL CHARACTERISTICS

Parameter	Conditions	Min	Typ	Max	Min	Typ	Max	Units
Open Loop Gain	$R_{L1} = 100\Omega$		100			*		dB
Rated Output Current (not short circuit protected)	$R_{L1} = >100\Omega$		±100			*		mA
Rated Output Voltage	$R_{L1} = >200\Omega$	±10			*			V
Input Offset Voltage Initial	Adjustable to Zero @ +25°C		±0.5	±1		*	*	mV
vs. Case Temperature				±2			*	mV
vs. Power Supply Voltage			10			*		$\mu\text{V}/^\circ\text{C}$
Input Bias Current Initial	@ +25°C		1	2		*	*	nA
vs. Temperature			Doubles			*		/10°C
Input Offset Current Initial	@ +25°C		±100			*		pA
Input Impedance Differential	}In parallel with 5pF		$10^{10}$			*		$\Omega$
Common Mode			$10^{10}$			*		$\Omega$
Input Voltage Range Common Mode		±10		±18	*		*	V
Differential				±18			*	V
Common Mode Rejection			70			*		dB
Input Noise dc to 100kHz	$R_{FF} = 100\Omega$ ; $R_{FB} = 1k\Omega$		5			*		$\mu\text{V rms}$
dc to 2MHz			7			*		$\mu\text{V rms}$

## AC ELECTRICAL CHARACTERISTICS<sup>1</sup>

Parameter	Conditions	Min	Typ	Max	Min	Typ	Max	Units
Slew Rate	$A = -1$ ; $R_{FF} = R_{FB} = 500\Omega$ ; Load = 100 $\Omega$		300			*		V/ $\mu\text{s}$
Noninverting Slew Rate	$A = 2$ ; $R_{FF} = R_{FB} = 1000\Omega$ ; Load = 100 $\Omega$		320			*		V/ $\mu\text{s}$
Overload Recovery	50% Overdrive		400			*		ns
Gain Bandwidth Product	$R_{FF} = R_{FB} = 500\Omega$		100			*		MHz
Small Signal Bandwidth, -3dB	$A = -1$ ; $R_{FF} = R_{FB} = 500\Omega$		45			*		MHz
	$A = -1$ ; $R_{FF} = R_{FB} = 1000\Omega$		35			*		MHz
	$A = -2$ ; $R_{FF} = 500\Omega$ ; $R_{FB} = 1000\Omega$		35			*		MHz
	$A = -4$ ; $R_{FF} = 250\Omega$ ; $R_{FB} = 1000\Omega$		30			*		MHz
Output Impedance				<1			*	$\Omega$
Noninverting Bandwidth, -3dB	$A = 2$ ; $R_{FF} = R_{FB} = 1000\Omega$ ; 100 $\Omega$ load; 10pF capacitance							
	5-volt p-p output		25			*		MHz
	4-volt p-p output		30			*		MHz
	2-volt p-p output		55			*		MHz
	$A = 3$ ; $R_{FF} = 500\Omega$ ; $R_{FB} = 1000\Omega$ ; load = 100 $\Omega$ , 1000 $\Omega$ , or 2000 $\Omega$ ; capacitance = 10pF							
	10-volt p-p output		17			*		MHz
	5-volt p-p output		25			*		MHz

**AC ELECTRICAL CHARACTERISTICS<sup>1</sup> (Continued)**

Parameter	Conditions	HOS-060SH			HOS-060SH/883			Units
		Min	Typ	Max	Min	Typ	Max	
Noninverting Bandwidth, -3dB (continued)	A = 5; R <sub>FF</sub> = 500Ω; R <sub>FB</sub> = 2000Ω; 100Ω, 1000Ω, or 2000Ωload/10pF capacitance							
	5-volt p-p output		15			*		MHz
	4-volt p-p output		30			*		MHz
	2-volt p-p output		40			*		MHz
	1-volt p-p output		40			*		MHz
Full Power Bandwidth (-3dB)	Output = ±5V; A = -1; Load = 100Ω		20			*		MHz
Settling Time to 0.1% Inverting	A = -1; R <sub>FF</sub> = R <sub>FB</sub> = 500Ω V <sub>OUT</sub> = ±5V		100			*		ns
	V <sub>OUT</sub> = ±2.5V		80			*		ns
Noninverting	A = 2; R <sub>FF</sub> = R <sub>FB</sub> = 500Ω Max Load capacitance = 75pF							
	V <sub>OUT</sub> = ±5V		200			*		ns
	V <sub>OUT</sub> = ±2.5V		135			*		ns
Harmonic Distortion (See Figure 5)	A = -1; Load = 1000Ω Signal = 4MHz; 2V output		-63			*		dB
Noninverting Harmonic Distortion (See Figure 6)	A = 2; R <sub>FF</sub> = R <sub>FB</sub> = 1000Ω; Load = 1000Ω; Signal = 4MHz; 2V output		-59			*		dB
Power Supply	Rated performance	Voltage		±15				V dc
		Voltage	±12		±18	*		V dc
		Current		±20	±25		*	mA
		Power Consumption		0.6			*	W
		Power Dissipation			1.25			W
Temperature Range	(See Figure 2 for Derating Information)	Operating (Case)	-55		+125	*		°C
		Storage	-65		+150	*		°C
Meantime Between Failures (MTBF)	MIL-HNBK 217; Ground; Fixed; Case = 70°C 883B Processing					2.78 × 10 <sup>6</sup>		Hours
Price:	1-4	100s						
HOS-060SH		\$150	\$105					
HOS-060SH/883		\$205	\$185					

FOR APPLICATIONS ASSISTANCE, CALL (919) 292-6427

**Notes:**

<sup>1</sup>Specification for Inverting Mode unless otherwise noted.  
\*Specifications same as HOS-060SH.

Individual socket assemblies (one per pin) are available from AMP as part number 6-330808-0.  
Specifications subject to change without notice.

**OUTLINE DIMENSIONS**

Dimensions shown in inches and (mm).

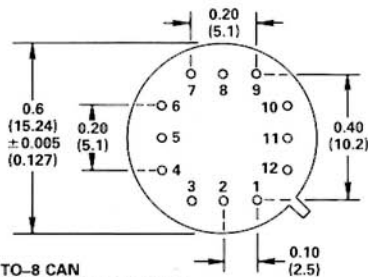
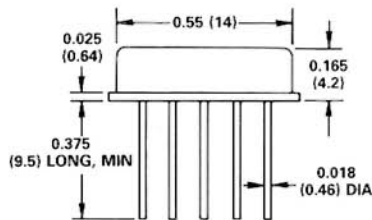

TO-8 CAN  
PINS ARE GOLD PLATED

BOTTOM VIEW

**PIN DESIGNATIONS**

PINS	FUNCTION
1	+V
2	GROUND
3	OFFSET ADJ*
4	OFFSET ADJ*
5	-INPUT
6	+INPUT
7	NC
8	GROUND
9	-V
10	-V
11	OUTPUT
12	+V

\*PINS FOR CONNECTING OPTIONAL  
OFFSET POTENTIOMETER.

**HOS-060  
OUTLINE AND PIN DESIGNATIONS**

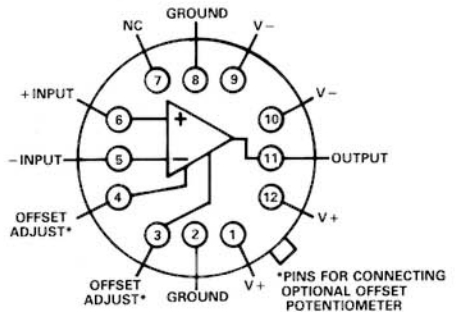

TO-8 PACKAGE  
BOTTOM VIEW

## VOLTAGE AMPLIFIERS/CURRENT BOOSTERS

Video op amps such as the HOS-060 are generally characterized by high gain bandwidth products, fast settling times, and high output drive.

One of the most common uses of video op amps is for D/A converter output voltage amplification or current boosting. Figure 3 is one example of this type of application. In this circuit, the internal resistance of the D/A is the feed-forward resistor for the op amp.

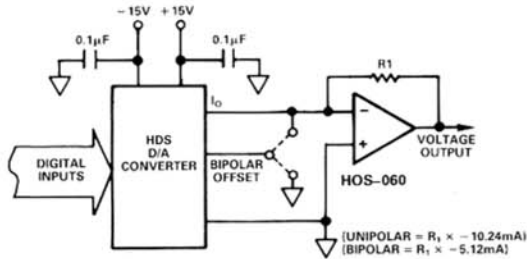

Figure 3. Inverting Unipolar or Bipolar Voltage Output

The circuit which is shown will provide a negative unipolar output with binary coding on the input, and bipolar offset grounded. It will provide a bipolar output with complementary offset binary coding on the input, and bipolar offset connected to  $I_O$ .

## OFFSET AND GAIN ADJUSTMENT

The low value of offset may preclude the need for adjustment, but Figure 4 shows a method of adjusting both offset and gain.

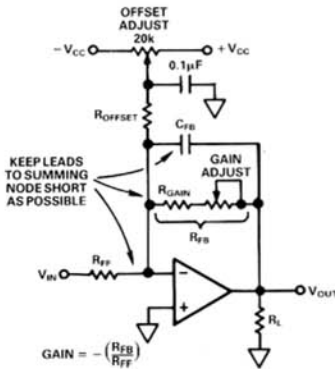

Figure 4. HOS-060 Offset and Gain Adjust

As shown, the gain of the circuit is established by the equation:

$$G = - \left( \frac{R_{FB}}{R_{FF}} \right) \text{ where } R_{FB} = R_{GAIN} + \text{Gain Adjust.}$$

Once the user has established the desired gain for the illustrated circuit, the value of  $R_{FB}$  can be used to determine the correct value of  $R_{OFFSET}$  with the equation:

$$R_{OFFSET} = - \left( \frac{V_{CC} \times R_{FB}}{\Delta E_O} \right)$$

where  $\Delta E_O$  is the desired amount of offset on the output.

Note:  $R_{FF}$ ,  $R_{GAIN}$ ,  $C_{FB}$  and  $R_{OFFSET}$  must be located as close to the summing node of the HOS-060 as physically possible. This helps prevent additional capacitance in the summing node and corresponding bad effects on frequency response and settling times.

Variable controls (such as Offset Adjust and Gain Adjust) should never be tied to the summing node of the op amp. Their correct electrical locations are those shown in Figure 4.

## NONINVERTING OPERATION

The vast majority of video operational amplifiers display marked differences in settling times and bandwidths when operated in a noninverting mode instead of the inverting mode. There are a number of valid reasons for this characteristic.

Most high-speed op amps use feed-forward compensation for optimizing performance in the inverting mode. This is necessary to obtain wide gain-bandwidth products while maintaining dc performance in these types of devices. In effect, the op amp has a wideband ac channel which is not perfectly matched to the dc channel.

Feed-forward techniques enhance the performance of the op amp in the inverting mode by increasing the slew rate and small-signal bandwidth. These techniques, however, also decrease the amplifier's tolerance to stray capacitances, so must be employed judiciously.

The Analog Devices HOS-060 has different performance characteristics when operating as a noninverting amplifier, but the care used in the design makes the differences less pronounced than they are in many competing units.

The HOS-060 can be considered a true differential video op amp. It requires little or no external compensation because its rolloff characteristics approach a 6dB/octave slope. This helps the user determine summing errors and loop response; and helps assure the stability of the system.

The performance parameters for both inverting and noninverting operation are shown elsewhere in this data sheet (see SPECIFICATIONS section and figures). A comparison of the characteristics will highlight the similarities in performance, with the exceptions noted above.

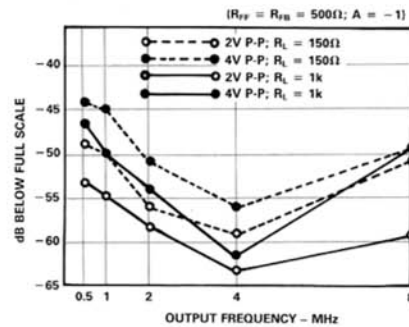

Figure 5. Harmonic Distortion - Inverting

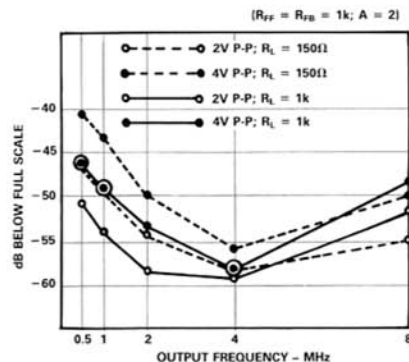

Figure 6. Harmonic Distortion - Noninverting

**THE READER IS URGED TO CONSULT THE HOS-050 DATA SHEET FOR ADDITIONAL APPLICATIONS INFORMATION. THE HOS-060 IS PIN-FOR-PIN COMPATIBLE WITH THE HOS-050 SERIES AND CAN BE USED IN SIMILAR WAYS.**