

# VKA60xS

## 60 Watt Single Output Half Brick DC/DC Converter

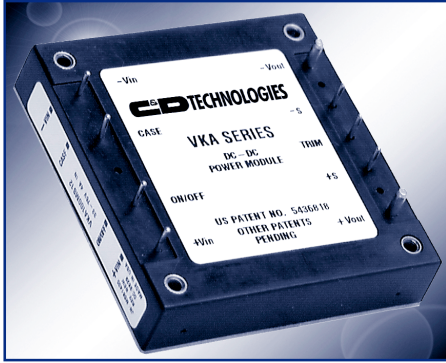

- 18-36 V & 33 - 75V Input Range
- High Efficiency: 87% Typical at 5V
- 100µS Transient Response 50-100% Load Step
- 420 kHz Fixed-Frequency Operation
- Remote Sense
- Operation to +100°C Baseplate Temperature
- Primary Remote On/Off, Choice of Pos/Neg Logic
- Adjustable Output Voltage
- Continuout Short-Circuit Protection
- Thermal Shutdown
- Case Ground Pin



The VKA60xS Series DC/DC converters present an economical and practical solution for distributed power system architectures which require high power density and efficiency while maintaining system modularity and upgradeability. With the ability to operate over a wide input voltage range of 18 to 36 and 33 to 75 volts, these modules are

ideal for use in battery backup applications common in today's telecommunication and electronic data processing applications. The output is fully isolated from the input, allowing for a variety of polarity and grounding configurations.

The VKA60xS's proprietary control circuitry responds to 50-100%

load steps in 100µSeconds to within 1% nominal Vout.

The patented fixed frequency architecture combined with surface mount technology results in a compact, efficient and reliable solution to DC/DC conversion requirements. Safety per UL1950, EN 60950 and CSA 22.2 #234

### PRODUCT SELECTION CHART

MODEL	INPUT VOLTAGE	VOUT (VDC)	IOUT (A)	EFFICIENCY	
				MIN	TYP
VKA60LS03		3.3V	12.0	80	81
VKA60LS05	24VDC	5.0V	12.0	85	86
VKA60LS12		12.0V	5.0	87	88
VKA60LS15	(18-36)	15.0V	4.0	88	89
VKA60LS24		24.0V	2.5	89	90
VKA60MS03		3.3V	12.0	81	82
VKA60MS05	48VDC	5.0V	12.0	86	87
VKA60MS12		12.0V	5.0	88	89
VKA60MS15	(33-75)	15.0V	4.0	89	90
VKA60MS24		24.0V	2.5	89	90



TYPICAL PERFORMANCE CURVES  
T<sub>CASE</sub> = +40°C nominal input voltage unless otherwise specified.

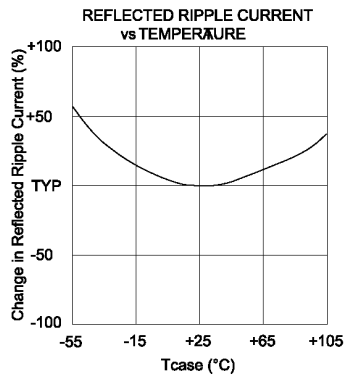
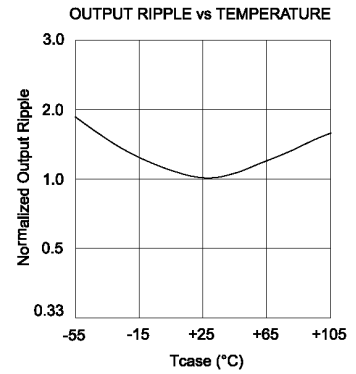
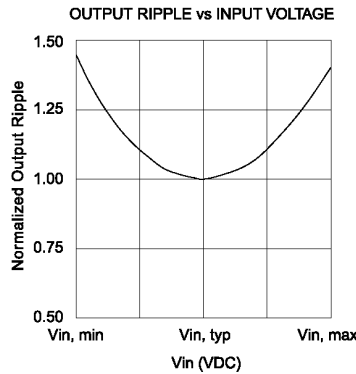
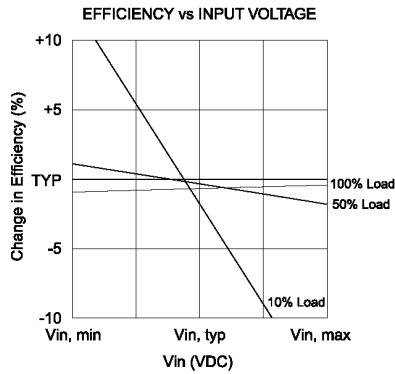
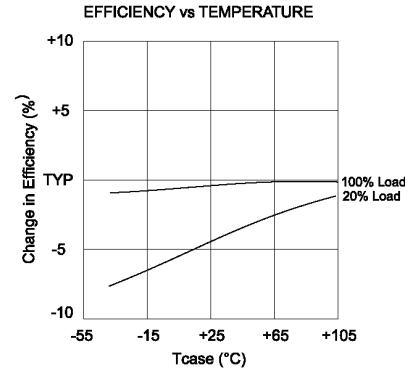
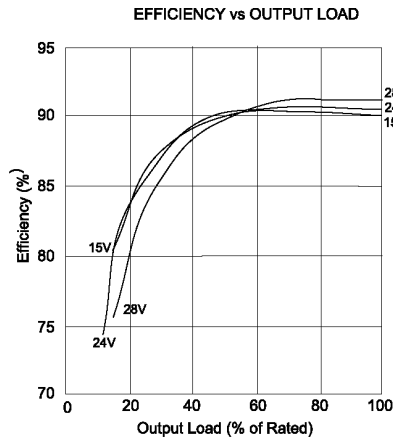
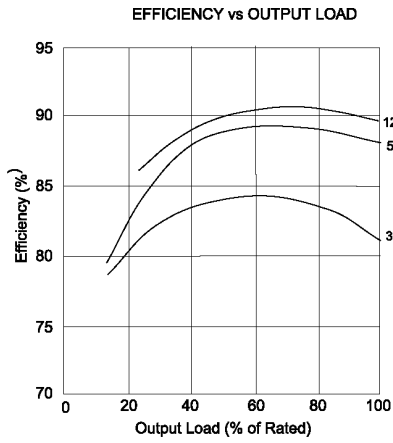

**POWER DERATING WITH NO HEATSINK**

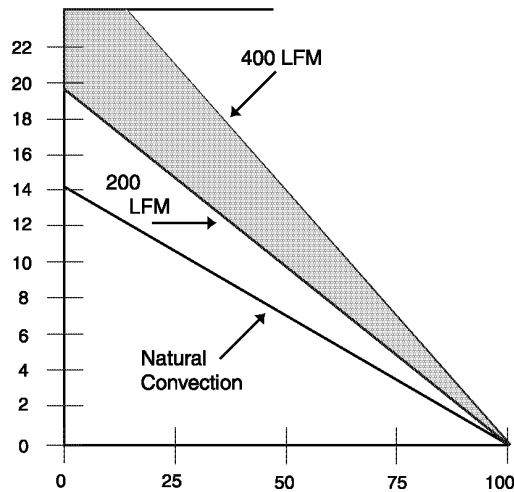

ORDERING INFORMATION

Device Family VKA60 xSzz -  
 Indicates 60 Watt Regulated Unit  
 Model Number \_\_\_\_\_  
 Selected from Table of Electrical Characteristics  
 Where:  
 x = Input Voltage (L = 24VDC; M = 48VDC)  
 zz = Output Voltage (03=3.3V, 05=5V, etc.)  
 Lead Length \_\_\_\_\_  
 0.200" - No Number  
 0.145" - (6)  
 0.110" - (8)  
 Remote On-Off Logic: \_\_\_\_\_  
 Positive - No Number  
 Negative - (1)

# MECHANICAL

## SIDE VIEW

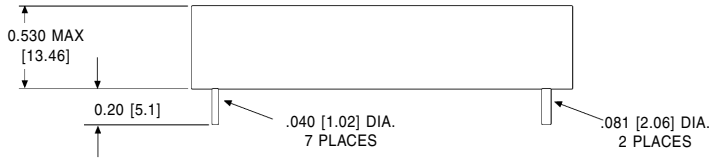

## NOTES:

All dimensions are in inches (millimeters).

PIN PLACEMENT TOLERANCE:  $\pm 0.005$ "

MECHANICAL TOLERANCE:  $\pm 0.015$ "

Marked with: specific model, ordered, date code, job code.

**MATERIAL:** Units are encapsulated in a low thermal resistance molding compound which has excellent chemical resistance and electrical properties in high humidity environments and over a wide operating temperature range. The encapsulant and outer shell of the unit have UL94V-0 ratings. Lead material is solder plated to allow ease of solderability.

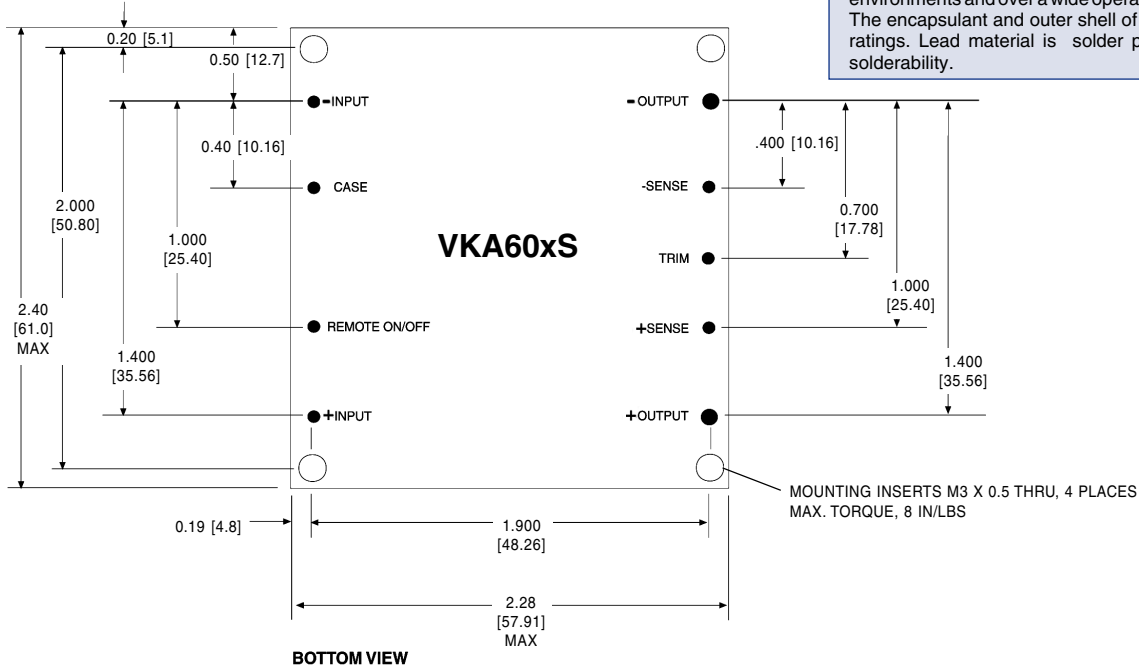

## BOTTOM VIEW

## OUTPUT ADJUST VOLTAGE

This feature allows the user to accurately adjust the module's output voltage set point to a specified level. This is achieved by connecting a resistor or potentiometer from the TRIM terminal to either the +V<sub>out</sub> terminal (for increased V<sub>out</sub>) or the -V<sub>out</sub> terminal (for decreased V<sub>out</sub>). The formulae below describe the trim resistor value to obtain a V<sub>out</sub> change of  $\Delta\%$ . V<sub>o</sub> is output voltage prior to adjustment (3.3V, 5V, 12V, 15V, or 24V).

$$\text{Radj - up} = \left( \frac{V_o(100 + \Delta\%)}{1.225\Delta\%} - \frac{(100 + 2\Delta\%)}{\Delta\%} \right) \text{ k}\Omega$$

$$\text{Radj - down} = \left( \frac{100}{\Delta\%} - 2 \right) \text{ k}\Omega$$

## OVP NOTE

Special attention should be given to the peak voltage deviation during a dynamic load step when trimming the output above the original set point to avoid tripping the overvoltage protection circuit. Should an OVP condition occur, the converter will go into a latch condition and must be externally reset before it will return to normal operation.

**C&D Technologies (Power Electronics) Ltd.**  
Shannon, Co. Clare, Ireland  
Tel: +353.61.474.133 Fax: +353.61.474.141

**Power Electronics Division, United States**  
3400 E Britannia Drive, Tucson, Arizona 85706  
Tel: 800.547.2537 Fax: 520.770.9369

**C&D Technologies, (NCL)**  
Milton Keynes MK14 5BU UK  
Tel: +44 (0)1908 615232 Fax: +44 (0)1908 617545

Any data, prices, descriptions or specifications presented herein are subject to revision by C&D Technologies, Inc. without notice. While such information is believed to be accurate as indicated herein, C&D Technologies, Inc. makes no warranty and hereby disclaims all warranties, express or implied, with regard to the accuracy or completeness of such information. Further, because the product(s) featured herein may be used under conditions beyond its control, C&D Technologies, Inc. hereby disclaims all warranties, either express or implied, concerning the fitness or suitability of such product(s) for any particular use or in any specific application or arising from any course of dealing or usage of trade. The user is solely responsible for determining the suitability of the product(s) featured herein for user's intended purpose and in user's specific application. C&D Technologies, Inc. does not warrant or recommend that any of its products be used in any life support or aviation or aerospace applications.