

DESCRIPTION

The RH1014M is the first precision quad operational amplifier which directly upgrades designs in the industry standard 8-pin DIP LM124/LM148/OP-11/5156 pin configuration. Low offset voltage (300 μ V max), low drift (2.5 μ V/ $^{\circ}$ C), low offset current (1.5nA), and high gain (1.2 million min) combine to make the RH1014M four truly precision amplifiers in one package.

The wafer lots are processed to Linear Technology's in-house Class S flow to yield circuits usable in stringent military applications.

ABSOLUTE MAXIMUM RATINGS

Supply Voltage	± 22 V
Differential Input Voltage	± 30 V
Input Voltage	Equal to Positive Supply Voltage 5V Below Negative Supply Voltage
Output Short-Circuit Duration	Indefinite
Operating Temperature Range	-55° C to 125° C
Storage Temperature Range	-65° C to 150° C
Lead Temperature (Soldering, 10 sec)	300° C

LT, LTC and LT are registered trademarks of Linear Technology Corporation.

BURN-IN CIRCUIT

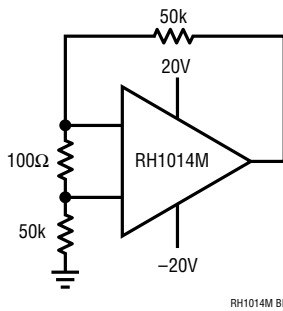

PACKAGE INFORMATION

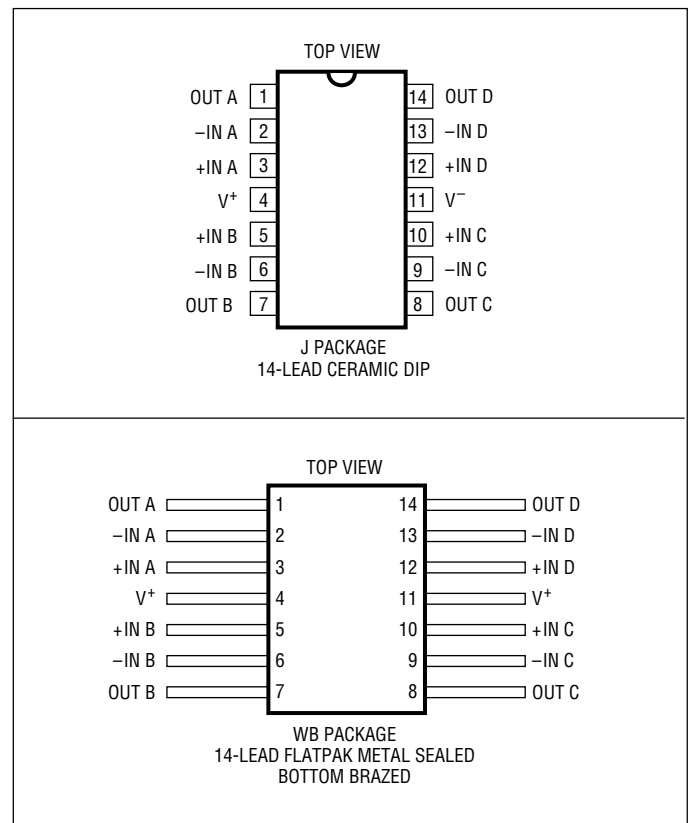

TABLE 1: ELECTRICAL CHARACTERISTICS (Pre-Irradiation) $V_S = \pm 15V$, $V_{CM} = 0V$, unless otherwise noted.

SYMBOL	PARAMETER	CONDITIONS	NOTES	$T_A = 25^\circ C$			SUB-GROUP	$-55^\circ C$ T_A $125^\circ C$			SUB-GROUP	UNITS
				MIN	TYP	MAX		MIN	TYP	MAX		
V_{OS}	Input Offset Voltage	$V_{CM} = 0.1V$				300	1		550	2,3	μV	
			2			450	1				μV	
			2						750	2	μV	
$\frac{V_{OS}}{\text{Temp}}$	Average Tempco of Offset Voltage		1					2.5		$\mu V/^\circ C$		
$\frac{V_{OS}}{\text{Time}}$	Long Term V_{OS} Stability				0.5					$\mu V/Mo$		
I_{OS}	Input Offset Current					10	1		20	2,3	nA	
			2			10	1		20	2,3	nA	
I_B	Input Bias Current					30	1		45	2,3	nA	
			2			50	1		120	2,3	nA	
e_n	Input Noise Voltage	0.1Hz to 10Hz			0.55						μV_{P-P}	
	Input Noise Voltage Density	$f_0 = 10Hz$			24						nV/ \sqrt{Hz}	
		$f_0 = 1000Hz$				22					nV/ \sqrt{Hz}	
i_n	Input Noise Current Density	$f_0 = 10Hz$			0.07						pA/ \sqrt{Hz}	
R_{IN}	Input Resistance	Differential	1	70							M	
		Common Mode			4						G	
A_{VOL}	Large-Signal Voltage Gain	$V_0 = \pm 10V$, $R_L = 2k$			1.2		4	0.25		5,6	V/ μV	
		$V_0 = \pm 10V$, $R_L = 600$			0.5		4				V/ μV	
		$V_0 = 5mV$ to $4V$, $R_L = 500$	2		1						V/ μV	
	Input Voltage Range		1	13.5							V	
			1	-15.0							V	
			1,2	3.5							V	
			1,2	0							V	
CMRR	Common-Mode Rejection Ratio	$V_{CM} = 13.5V$, $-15V$			97		1				dB	
		$V_{CM} = 13V$, $-14.9V$						94		2,3	dB	
PSRR	Power Supply Rejection Ratio	$V_S = \pm 2V$ to $\pm 18V$			100		1	97		2,3	dB	
	Channel Separation	$V_0 = \pm 10V$, $R_L = 2k$			120		1				dB	
V_{OUT}	Output Voltage Swing	$R_L = 2k$			± 12.5		4	± 11.5		5,6	V	
		Output Low, No Load	2		25		4				mV	
		Output Low, 600 to GND	2		10		4		18	5,6	mV	
		Output Low, $I_{SINK} = 1mA$	2		350		4				mV	
		Output High, No Load	2	4.0			4				V	
		Output High, 600 to GND	2	3.4			4		3.1	5,6	V	
SR	Slew Rate				0.2		4				V/ μs	
I_S	Supply Current	Per Amplifier			0.55		1		0.70	2,3	mA	
			2			0.50		1		0.65	2,3	mA

TABLE 1A: ELECTRICAL CHARACTERISTICS (Post-Irradiation) (Note 3) $V_S = \pm 15V$, $V_{CM} = 0V$, $T_A = 25^\circ C$, unless otherwise noted.

SYMBOL	PARAMETER	CONDITIONS	NOTES	10KRAD(Si)		20KRAD(Si)		50KRAD(Si)		100KRAD(Si)		200KRAD(Si)		UNITS
				MIN	MAX	MIN	MAX	MIN	MAX	MIN	MAX	MIN	MAX	
V_{OS}	Input Offset Voltage				450		450		600		750		900	μV
			2		600		600		750		900			μV
I_{OS}	Input Offset Current				10		10		15		20		25	nA
			2		10		10		15		20			nA
I_B	Input Bias Current				60		75		100		175		250	nA
			2		80		100		125		200			nA
	Input Voltage Range		1	13.5		13.5		13.5		13.5		13.5		V
			1	-15.0		-15.0		-15.0		-15.0		-15.0		V
			2	3.5		3.5		3.5		3.5				V
			2	0		0		0		0				V
CMRR	Common-Mode Rejection Ratio	$V_{CM} = 13V, -15V$			97		97		94		90		86	dB
PSRR	Power Supply Rejection Ratio	$V_S = \pm 10V$ to $\pm 18V$			100		98		94		86		80	dB
A_{VOL}	Large-Signal Voltage Gain	$R_L = 10k, V_O = \pm 10V$			500		200		100		50		25	V/mV
V_{OUT}	Maximum Output Voltage Swing	$R_L = 10k$			± 12.5		± 12.5		± 12.5		± 12.5		± 12.5	V
		Output Low, No Load	2		25		30		40		50			mV
		Output Low, 600 Ω to GND	2		10		10		10		10			mV
		Output Low, $I_{SINK} = 1mA$	2		0.6		0.8		1.0		1.6			V
		Output High, No Load	2		4.0		4.0		4.0		4.0			V
		Output High, 600 Ω to GND	2		3.4		3.2		3.0		2.8			V
SR	Slew Rate	$R_L = 10k$			0.13		0.12		0.11		0.07		0.01	V/ μs
I_S	Supply Current	Per Amplifier			0.55		0.55		0.55		0.55		0.55	mA
			2		0.50		0.50		0.50		0.50			mA

Note 1: Guaranteed by design, characterization, or correlation to other tested parameters..

Note 2: Specification applies for $V_S^+ = 5V$, $V_S^- = 0V$, $V_{CM} = 0V$, $V_{OUT} = 1.4V$.

TABLE 2: ELECTRICAL TEST REQUIREMENTS

MIL-STD-883 TEST REQUIREMENTS	SUBGROUP
Final Electrical Test Requirements (Method 5004)	1*,2,3,4,5,6
Group A Test Requirements (Method 5005)	1,2,3,4,5,6
Group B and D for Class S, and Group C and D for Class B	1,2,3
End Point Electrical Parameters (Method 5005)	

* PDA applies to subgroup 1. See PDA Test Notes.

PDA Test Notes

The PDA is specified as 5% based on failures from group A, subgroup 1, tests after cooldown as the final electrical test in accordance with method 5004 of MIL-STD-883. The verified failures of group A, subgroup 1, after burn-in divided by the total number of devices submitted for burn-in in that lot shall be used to determine the percent for the lot.

Linear Technology Corporation reserves the right to test to tighter limits than those given.

TOTAL DOSE BIAS CIRCUIT

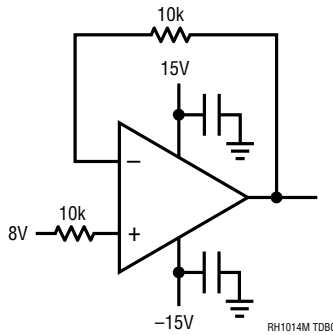

TYPICAL PERFORMANCE CHARACTERISTICS

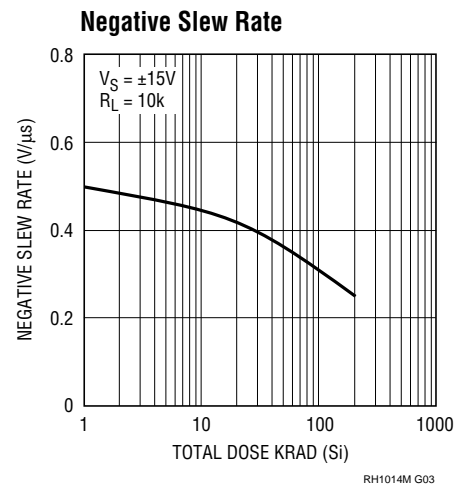
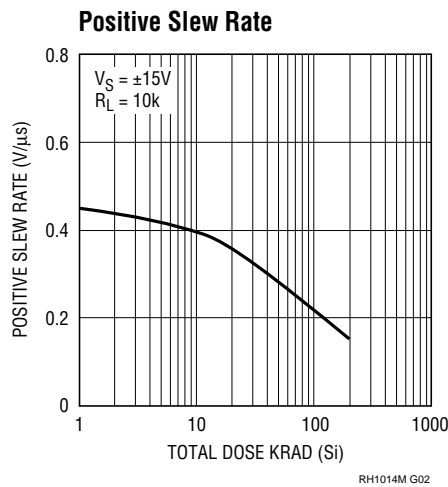
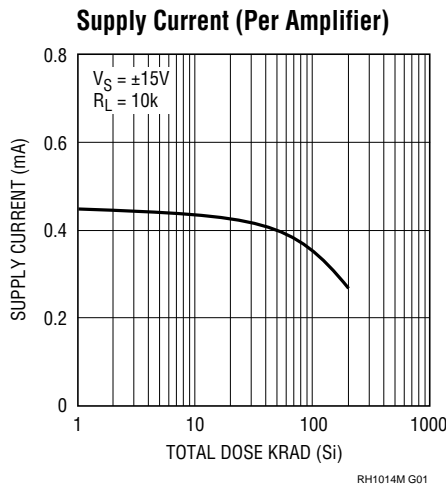

TYPICAL PERFORMANCE CHARACTERISTICS

Input Offset Voltage

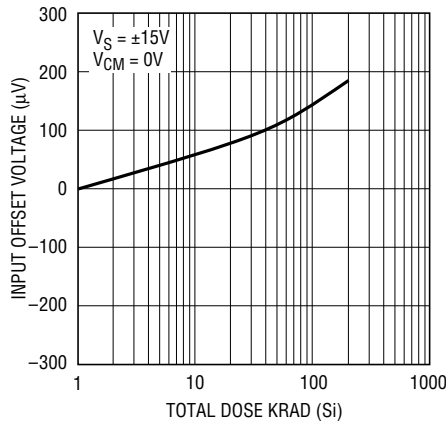

RH1014M G04

Input Bias Current

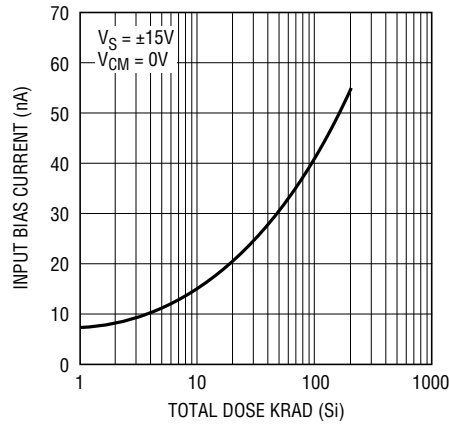

RH1014M G05

Input Offset Current

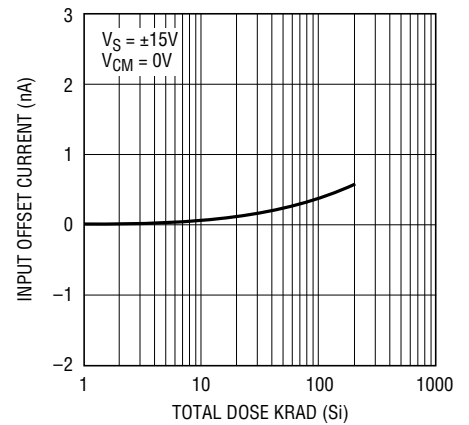

RH1014M G06

Open-Loop Gain

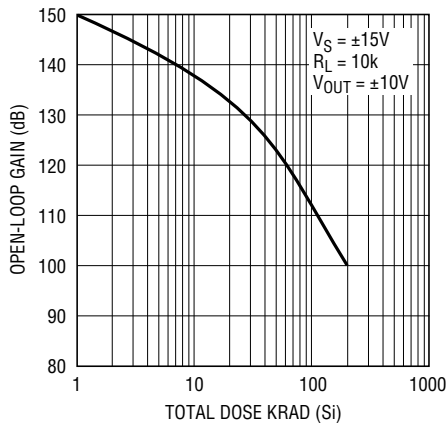

RH1014M G07

Common-Mode Rejection Ratio

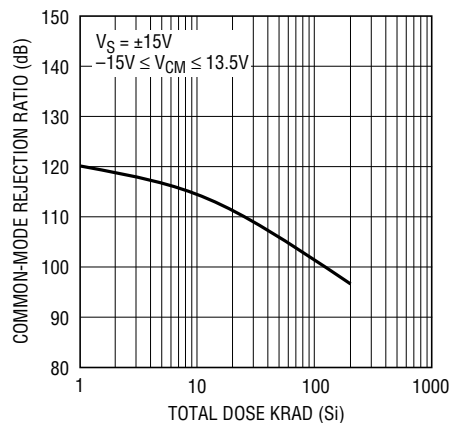

RH1014M G08

Power Supply Rejection Ratio

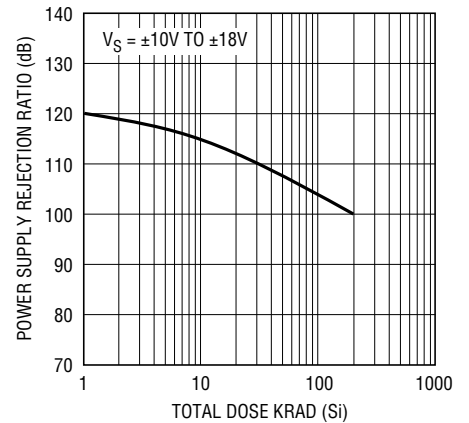

RH1014M G09

Input Noise Voltage Density

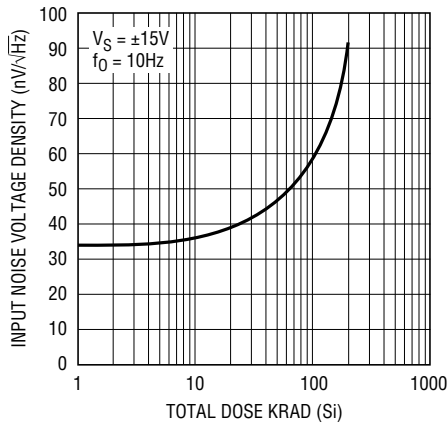

RH1014M G10

Gain Bandwidth Product

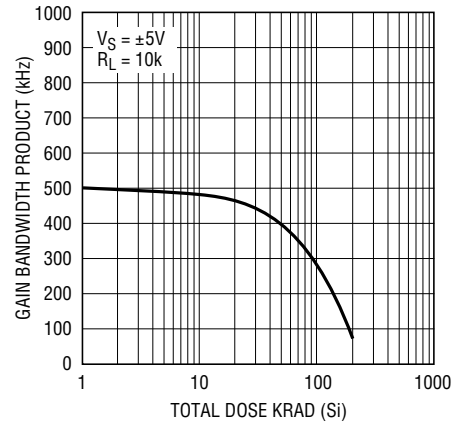

RH1014M G11

Microcircuit Part Numbering System

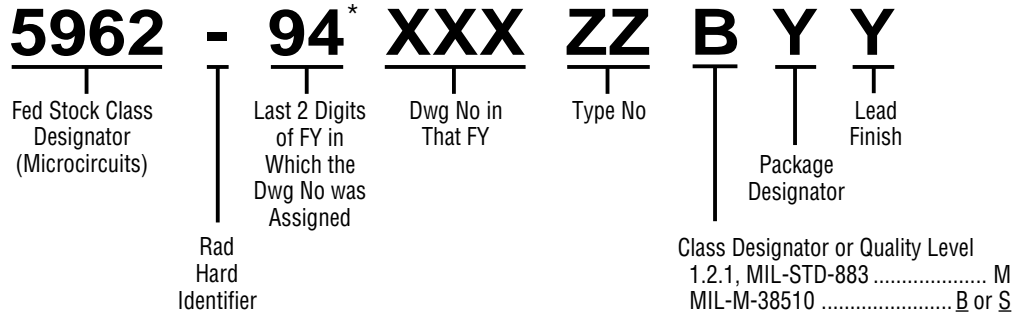

* For existing MIL-M-38510 associated detail specification sheet, the "Last 2 Digits of FY" and drawing number will consist of first two digits of MIL-M-38510 (i.e., 38) followed by the three digit identifier assigned to the detail sheet (i.e., g/339).

Operational Amplifiers

Generic	SMD 5962-
LT [®] 1001AMH, J8	8773803GA, PA
LT1001MH, J8	8773801GA, PA
LT1002AMJ	8771501CA
LT1006AMH, J8	8993301MGA, PA
LT1006MH, J8	8993302MGA, PA
LT1007AMH, J8	8757801GA, PA
LT1012AMH, D	9084202MGA, PA
LT1012MH, D	9084201MGA, PA
LT1013AMH, J8	8876001GA, PA
LT1013MH, J8	8876002GA, PA
LT1014AMJ	8967701CA
LT1014MJ	8967702CA
LT1028AMH, J8	8862202GA, PA
LT1028MH, J8	8862201GA, PA
LT1037AMH, J8	8856701GA, PA
LT1055AMH	8997601GA
LT1055MH	8997603GA
LT1056AMH	8997602GA
LT1056MH	8997604GA
LT1057AMH, J8	9081701MGA, PA
LT1057MH, J8	9081702MGA, PA
LT1058AMJ, L	8989701CA, XA
LT1058MJ	8989702CA
LT1078AMH	9163204MGA
LT1078AMJ8	9163206MPA
LT1078MH	9163203MGA
LT1078MJ8	9163203MPA
LT1079AMJ	9163202MCA
LT1079MJ	9163201MCA
LT1124AMJ8	9323804MPA
LT1124MJ8	9323802MPA
LT1125AMJ	9323803MCA
LT1125MJ	9323801MCA
LT1172MJ8	9207901MPA
LTC1051MH, J8	9460001MGA, PA
LTC1051AMH, J8	9460002MGA, PA
LTC1052MJ8, H, J	8978201PA, GA, CA

High Speed Op Amps

Generic	SMD 5962-
LT1022AMH	8962201GA
LT1022MH	8962202GA
LT1028AMH, J8	8862202GA, PA
LT1028MH, J8	8862201GA, PA
LT1037AMH, J8	8856701GA, PA
LT1056AMH	8997602GA
LT1056MH	8997604GA
LT1057AMH, J8	9081701MGA, PA
LT1057MH, J8	9081702MGA, PA
LT1058AMJ, L	8989701CA, XA
LT1058MJ	8989702CA
LT118AMJ8	9451601MPA
LT1229MJ8	9318401MPA
LT1230MJ	9318402MCA

Buffer Amplifiers

Generic	SMD 5962-
LT1010MH, K	8856201XA, YA

Analog-to-Digital Converters

Generic	SMD 5962-
LTC [®] 1291CMJ8	9305701MPA
LTC1292CMJ8	9305702MPA
LTC1293CMJ	9305703MEA
LTC1294CMJ	9305704MRA

Regulators

Generic	SMD 5962-
LT1003MK	8987301XA
LT1020MJ	9084101MCA
LT1033MK	8874101XA
LT1076HVMK	9311902MYA
LT1076MK	9311901MYA
LT1083MK-5	9073901MXA
LT1084MK	8952101XA
LT1084MK-5	9073902MXA
LT1085MK	8864601XA
LT1085MK-5	9073903MXA
LT1086MK, H	8998101XA, YA
LT1086MK-5	9073904MXA
LT1120MJ8	9322401MPA
LT1185MK	9469501MXA

References

Generic	SMD 5962-
LT1004MH-1.2	8859701XA
LT1004MH-2.5	8859702XA
LT1009MH	8961001XA
LT1019AMH-10	9059501GA
LT1019AMH-5	9059502GA
LT1019AMH-4.5	9059503GA
LT1019AMH-2.5	9059504GA
LT1019MH-10	9059505GA
LT1019MH-5	9059506GA
LT1019MH-4.5	9059507GA
LT1019MH-2.5	9059508GA
LT1021BMH-10	8860001GA
LT1021BMH-5	8876201GA
LT1021BMH-7	8864701GA
LT1021CMH-10	8860002GA
LT1021CMH-5	8876202GA
LT1021DMH-10	8860003GA
LT1021DMH-5	8876203GA
LT1021DMH-7	8864702GA
LT1029AMH	9051901XA
LT1029MH	9051902XA
LT1031BMH	8980201XA
LT1031CMH	8980202XA
LT1031DMH	8980203XA
LT580SH	8686101XA
LT580TH	8686102XA

Comparators

Generic	SMD 5962-
LT1010MH, K	8856201XA, YA
LT1011AMH, J8	9062701GA, PA
LT1011MH, J8	9062702GA, PA
LT1016MH, J8	8684501IA, PA
LT1017MH, J8	8950401GA, PA
LT1018MH, J8	8950402GA, PA
LTC1041MJ8	9470901MPA

Switching Regulators

Generic	SMD 5962-
LT1070HVMK	9082504MYA
LT1070MK	9082501MYA
LT1071HVMK	9082505MYA
LT1071MK	9082502MYA
LT1072HVMK	9082506MYA
LT1072MJ8, K	9082503MPA, YA
LT1074MK	9457601MYA
LT1074HVMK	9457602MYA
LT1111MJ8	9321201MPA
LTC1052MH, J8, J	8978201GA, PA, CA

Switching Power Supply Controllers

Generic	SMD 5962-
LT1241MJ8	9319001MPA
LT1242MJ8	9319002MPA
LT1243MJ8	9319003MPA
LT1244MJ8	9319004MPA
LT1245MJ8	9319005MPA

Interface Products

Generic	SMD 5962-
LT1039MJ16, J	8875102EA, VA
LT1080MJ	8766601VA
LT1081MJ	8766602EA
LT1180MJ	9172901MVA
LT1181MJ	9172902MEA
LT1280MJ	9172903MVA
LT1281MJ	9172904MEA
LTC1045MJ	9054501RA
LTC485MJ8	9208001MPA

Filters

Generic	SMD 5962-
LTC1060AMJ	8864101RA
LTC1062MJ8	9159501MPA
LTC1064-1AMJ	9069302MCA
LTC1064-1MJ	9069301MCA
LTC1064-4MJ, L	9064901EA, XA
LTC1064MJ	8948301CA

Rad Hard

This table provides example specifications for our Rad Hard products. For complete Rad Hard data sheets, contact 1-800-4-LINEAR.

DEVICE	SYMBOL	CONDITIONS	10Krad (Si)		20Krad (Si)		50Krad (Si)		80Krad (Si)		100Krad (Si)		200Krad (Si)		UNITS	PACKAGE OPTIONS
			MIN	MAX	MIN	MAX	MIN	MAX	MIN	MAX	MIN	MAX	MIN	MAX		
RH07	V_{OS} I_{OS}			90 2.8		150 4		200 8				250 12		300 20	μV nA	J8, H
RH27C	V_{OS} I_{OS}			100 75		130 75		180 90				280 120		400 180	μV nA	H, W
RH37C	V_{OS} I_{OS}			100 75		130 75		180 90				280 120		400 180	μV nA	H, W
RH101A	V_{OS} I_{OS}			2 10		2 10		2 10				2 10		3 20	mV nA	H, W
RH108A	V_{OS} I_{OS}			0.5 0.2		0.5 0.2		0.5 0.2		1.0 0.2					mV nA	H, W
RH117	V_{REF}	3V ($V_{IN} - V_{OUT}$) 40V 10mA I_{OUT} I_{MAX} , P P P_{MAX}	1.20	1.30	1.20	1.30	1.20	1.30			1.20	1.30			V	H, K
RH118	V_{OS} SR	$V_S = \pm 15V$, $A_V = 1$		4 50		4 50		4 50				4 50		10 50	mV V/ μs	H, W
RH119	V_{OS} I_{OS}			4 75		4 100		4 150				4 300		8 500	mV nA	H, J, W
RH129	V_Z V z/ TEMP	RH129A RH129B RH129C	6.7	7.2 10 20 50	6.7	7.2 10 20 50	6.7	7.2 10 20 50			6.7	7.2 15 25 55	6.7	7.2 20 30 60	V ppm/ $^{\circ}C$ ppm/ $^{\circ}C$ ppm/ $^{\circ}C$	H
RH137	V_{REF}	$ V_{IN} - V_{OUT} $ 5V, $I_{OUT} = 10mA$ 3V $ V_{IN} - V_{OUT} $ 40V 10mA I_{OUT} I_{MAX} , P P P_{MAX}	-1.225 -1.2	-1.275 -1.3	-1.225 -1.2	-1.275 -1.3	-1.225 -1.2	-1.275 -1.3			-1.225 -1.2	-1.275 -1.3	-1.22 -1.2	-1.23 -1.3	V V	K, H
RH1009	V_Z V z/ I Z		2.495	2.505 6	2.495	2.505 6	2.495	2.505 8			2.495	2.505 10	2.495	2.505 12	V mV	H
RH1011	V_{OS} I_{OS}			1.5 4		1.5 4		1.5 4				1.5 20		2 50	mV nA	H, J8, W
RH1013	V_{OS} I_{OS}			450 10		450 10		600 15				750 20		900 25	μV nA	H, J8, W
RH1014	V_{OS} I_{OS}			450 10		450 10		600 15				750 20		900 25	μV nA	J, W
RH1021-5	V_{OUT} TCV _{OUT}	RH1021CM-5 RH1021BM-5, DM-5 RH1021BM-5 RH1021CM-5, DM-5	4.9975 4.95	5.0025 5.05	4.995 4.945	5.005 5.055	4.993 4.942	5.007 5.058			4.9925 4.94	5.008 5.06	4.99 4.935	5.01 5.065	V V ppm/ $^{\circ}C$ ppm/ $^{\circ}C$	H
RH1021-7	V_{OUT} TCV _{OUT}	RH1021BM-7 RH1021DM-7	6.95	7.05 5 20	6.95	7.05 5 20	6.95	7.05 5 20			6.94	7.06 7 22	6.93	7.07 10 25	V ppm/ $^{\circ}C$ ppm/ $^{\circ}C$	H
RH1021-10	V_{OUT} TCV _{OUT}	RH1021CM-10 RH1021BM-10, DM-10 RH1021BM-10 RH1021CM-10, DM-10	9.995 9.95	10.005 10.05	9.99 9.945	10.01 10.055	9.987 9.942	10.013 10.06			9.985 9.98	10.015 10.06	9.98 9.935	10.02 10.065	V V ppm/ $^{\circ}C$ ppm/ $^{\circ}C$	H
RH1056A	V_{OS} I_{OS}			180 ± 10		180 ± 50		250 ± 150				450 ± 250		450 ± 350	μV pA	H, W
RH1078	V_{OS} I_{OS}			350 2		500 18		650 13	75k 75k	800 18		1000 23			μV nA	H, J8, W J, W
RH1086	V_{REF} Dropout V	$I_{OUT} = 10mA$ $10mA \leq I_{OUT} \leq I_{FULL LOAD}$ $1.5V \leq (V_{IN} - V_{OUT}) \leq 15V$ $\Delta V_{REF} = 1\%$, $I_{OUT} = 1.5A$ (K) $\Delta V_{REF} = 1\%$, $I_{OUT} = 0.5A$ (H)	1.258		1.257		1.253				1.247		1.241		V V V	H, K

U.S. Area Sales Offices

NORTHEAST REGION

Linear Technology Corporation
3220 Tillman Drive, Suite 120
Bensalem, PA 19020
Phone: (215) 638-9667
FAX: (215) 638-9764

Linear Technology Corporation

266 Lowell Street, Suite B-8
Wilmington, MA 01887
Phone: (508) 658-3881
FAX: (508) 658-2701

NORTHWEST REGION

Linear Technology Corporation
1900 McCarthy Blvd., Suite 205
Milpitas, CA 95035
Phone: (408) 428-2050
FAX: (408) 432-6331

SOUTHEAST REGION

Linear Technology Corporation
17000 Dallas Parkway, Suite 219
Dallas, TX 75248
Phone: (214) 733-3071
FAX: (214) 380-5138

Linear Technology Corporation

5510 Six Forks Road, Suite 102
Raleigh, NC 27609
Phone: (919) 870-5106
FAX: (919) 870-8831

CENTRAL REGION

Linear Technology Corporation
Chesapeake Square
229 Mitchell Court, Suite A-25
Addison, IL 60101
Phone: (708) 620-6910
FAX: (708) 620-6977

SOUTHWEST REGION

Linear Technology Corporation
21243 Ventura Blvd., Suite 227
Woodland Hills, CA 91364
Phone: (818) 703-0835
FAX: (818) 703-0517

Linear Technology Corporation

15375 Barranca Parkway, Suite A-211
Irvine, CA 92718
Phone: (714) 453-4650
FAX: (714) 453-4765

International Sales Offices

FRANCE

Linear Technology S.A.R.L.
Immeuble "Le Quartz"
58 Chemin de la Justice
92290 Chatenay Malabry
France
Phone: 33-1-41079555
FAX: 33-1-46314613

GERMANY

Linear Technology GmbH
Oskar-Messter-Str. 24
85737 Ismaning
Germany
Phone: 49-89-962455-0
FAX: 49-89-963147

JAPAN

Linear Technology KK
5F NAO Bldg.
1-14 Shin-Ogawa-cho Shinjuku-ku
Tokyo, 162 Japan
Phone: 81-3-3267-7891
FAX: 81-3-3267-8510

KOREA

Linear Technology Korea Co., Ltd
Namsong Building, #403
Itaewon-Dong 260-199
Yongsan-Ku, Seoul 140-200
Korea
Phone: 82-2-792-1617
FAX: 82-2-792-1619

SINGAPORE

Linear Technology Pte. Ltd.
507 Yishun Industrial Park A
Singapore 2776
Phone: 65-753-2692
FAX: 65-754-4113

TAIWAN

Linear Technology Corporation
Rm. 602, No. 46, Sec. 2
Chung Shan N. Rd.
Taipei, Taiwan, R.O.C.
Phone: 886-2-521-7575
FAX: 886-2-562-2285

UNITED KINGDOM

Linear Technology (UK) Ltd.
The Coliseum, Riverside Way
Camberley, Surrey GU15 3YL
United Kingdom
Phone: 44-1276-677676
FAX: 44-1276-64851

World Headquarters

Linear Technology Corporation
1630 McCarthy Blvd.
Milpitas, CA 95035-7417
Phone: (408) 432-1900
FAX: (408) 434-0507