

PBSS4220V

20 V, 2 A NPN low V_{CEsat} (BISS) transistor

Rev. 01 — 6 February 2006

Product data sheet

1. Product profile

1.1 General description

NPN low V_{CEsat} Breakthrough In Small Signal (BISS) transistor in a SOT666 Surface Mounted Device (SMD) plastic package.

PNP complement: PBSS5220V.

1.2 Features

- Low collector-emitter saturation voltage V_{CEsat}
- High collector current capability: I_C and I_{CM}
- High collector current gain (h_{FE}) at high I_C
- High efficiency due to less heat generation
- Smaller required Printed-Circuit Board (PCB) area than for conventional transistors

1.3 Applications

- DC-to-DC conversion
- MOSFET gate driving
- Motor control
- Charging circuits
- Low power switches (e.g. motors, fans)
- Portable applications

1.4 Quick reference data

Table 1: Quick reference data

Symbol	Parameter	Conditions	Min	Typ	Max	Unit
V_{CEO}	collector-emitter voltage	open base	-	-	20	V
I_C	collector current		-	-	2	A
I_{CM}	peak collector current	$t_p \leq 300 \mu\text{s}$	-	-	4	A
R_{CEsat}	collector-emitter saturation resistance	$I_C = 1 \text{ A};$ $I_B = 100 \text{ mA}$	[1]	140	175	$\text{m}\Omega$

[1] Pulse test: $t_p \leq 300 \mu\text{s}; \delta \leq 0.02$.

PHILIPS

2. Pinning information

Table 2: Pinning

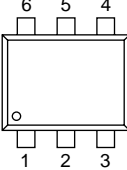
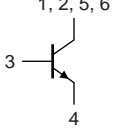
Pin	Description	Simplified outline	Symbol
1	collector		 sym014
2	collector		
3	base		
4	emitter		
5	collector		
6	collector		

3. Ordering information

Table 3: Ordering information

Type number	Package		
	Name	Description	Version
PBSS4220V	-	plastic surface mounted package; 6 leads	SOT666

4. Marking

Table 4: Marking codes

Type number	Marking code
PBSS4220V	N6

5. Limiting values

Table 5: Limiting values

In accordance with the Absolute Maximum Rating System (IEC 60134).

Symbol	Parameter	Conditions	Min	Max	Unit	
V_{CBO}	collector-base voltage	open emitter	-	20	V	
V_{CEO}	collector-emitter voltage	open base	-	20	V	
V_{EBO}	emitter-base voltage	open collector	-	5	V	
I_C	collector current		-	2	A	
I_{CM}	peak collector current	$t_p \leq 300 \mu s$	-	4	A	
I_B	base current		-	0.3	A	
I_{BM}	peak base current	$t_p \leq 300 \mu s$	-	0.6	A	
P_{tot}	total power dissipation	$T_{amb} \leq 25 \text{ }^\circ\text{C}$	[1] [4]	-	0.3	W
			[2] [4]	-	0.5	W
			[3] [4]	-	0.9	W
T_j	junction temperature		-	150	$^\circ\text{C}$	

Table 5: Limiting values ...continued

In accordance with the Absolute Maximum Rating System (IEC 60134).

Symbol	Parameter	Conditions	Min	Max	Unit
T_{amb}	ambient temperature		-65	+150	°C
T_{stg}	storage temperature		-65	+150	°C

- [1] Device mounted on an FR4 PCB, single-sided copper, tin-plated and standard footprint.
- [2] Device mounted on an FR4 PCB, single-sided copper, tin-plated, mounting pad for collector 1 cm².
- [3] Device mounted on a ceramic PCB, Al₂O₃, standard footprint.
- [4] Reflow soldering is the only recommended soldering method.

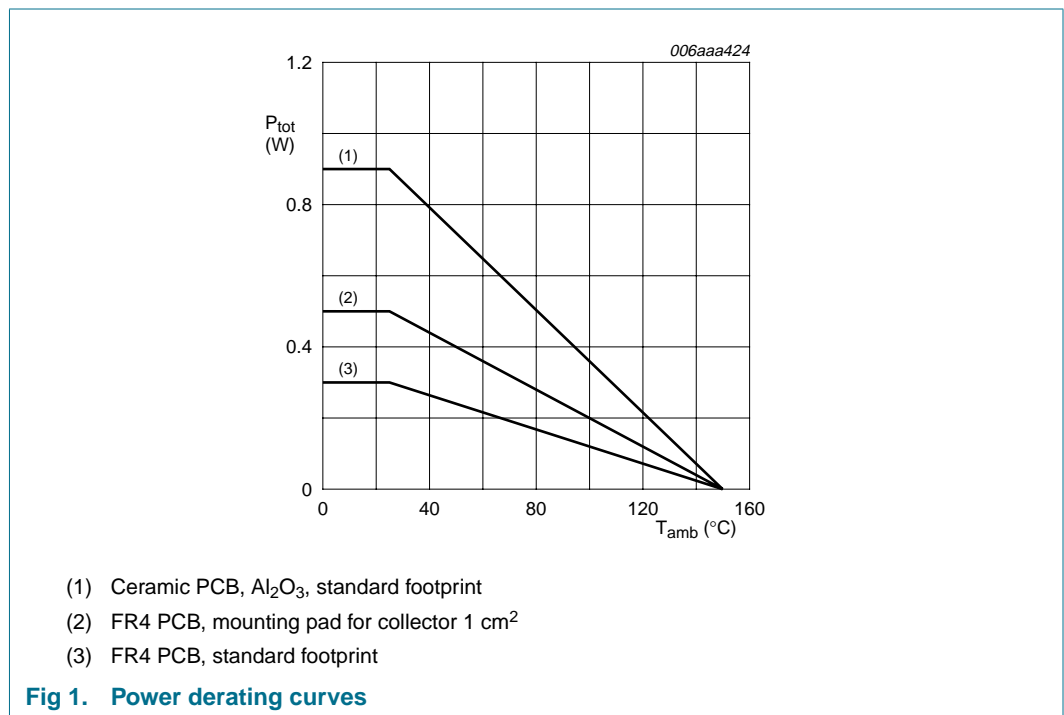

6. Thermal characteristics

Table 6: Thermal characteristics

Symbol	Parameter	Conditions	Min	Typ	Max	Unit	
$R_{th(j-a)}$	thermal resistance from junction to ambient	in free air	[1] [4]	-	-	410	K/W
			[2] [4]	-	-	250	K/W
			[3] [4]	-	-	140	K/W
$R_{th(j-sp)}$	thermal resistance from junction to solder point		-	-	80	K/W	

- [1] Device mounted on an FR4 PCB, single-sided copper, tin-plated and standard footprint.
- [2] Device mounted on an FR4 PCB, single-sided copper, tin-plated, mounting pad for collector 1 cm².
- [3] Device mounted on a ceramic PCB, Al₂O₃, standard footprint.
- [4] Reflow soldering is the only recommended soldering method.

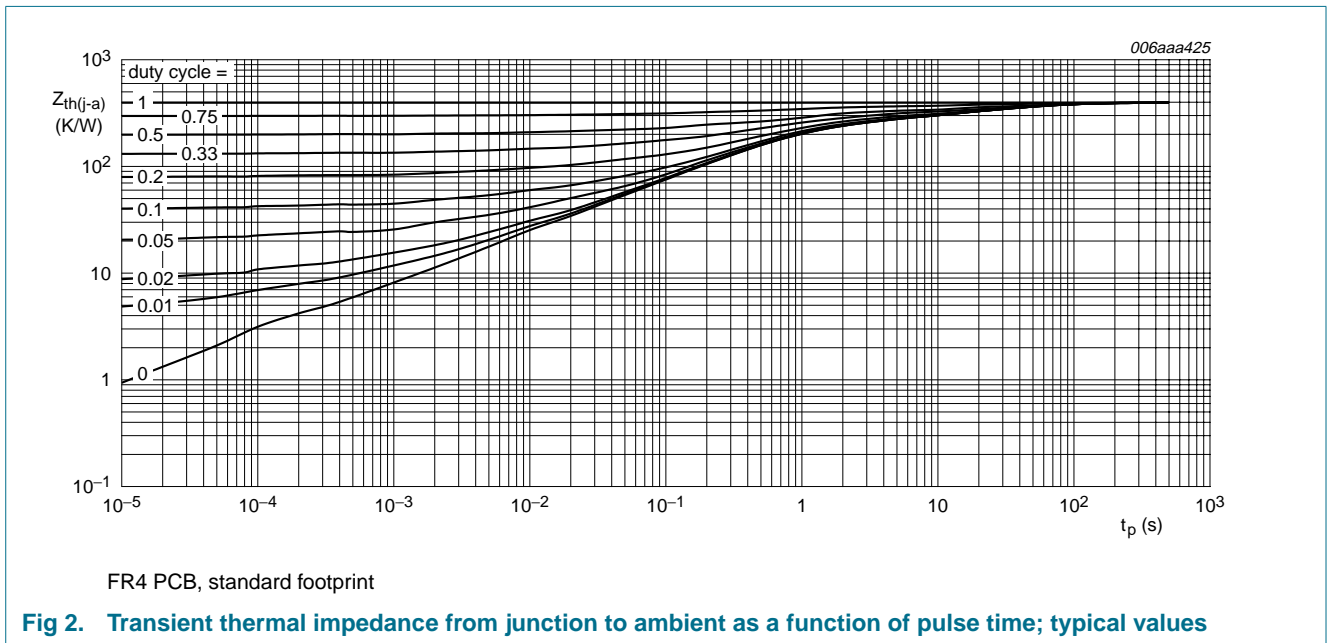

7. Characteristics

Table 7: Characteristics
 $T_{amb} = 25\text{ }^{\circ}\text{C}$ unless otherwise specified.

Symbol	Parameter	Conditions	Min	Typ	Max	Unit	
I_{CBO}	collector-base cut-off current	$V_{CB} = 20\text{ V}; I_E = 0\text{ A}$	-	-	0.1	μA	
		$V_{CB} = 20\text{ V}; I_E = 0\text{ A}; T_j = 150\text{ }^{\circ}\text{C}$	-	-	50	μA	
I_{CES}	collector-emitter cut-off current	$V_{CE} = 20\text{ V}; V_{BE} = 0\text{ V}$	-	-	0.1	μA	
I_{EBO}	emitter-base cut-off current	$V_{EB} = 5\text{ V}; I_C = 0\text{ A}$	-	-	0.1	μA	
h_{FE}	DC current gain	$V_{CE} = 2\text{ V}; I_C = 1\text{ mA}$	220	480	-		
		$V_{CE} = 2\text{ V}; I_C = 100\text{ mA}$	220	440	-		
		$V_{CE} = 2\text{ V}; I_C = 500\text{ mA}$	[1]	220	410	-	
		$V_{CE} = 2\text{ V}; I_C = 1\text{ A}$	[1]	200	360	-	
		$V_{CE} = 2\text{ V}; I_C = 2\text{ A}$	[1]	120	220	-	
V_{CEsat}	collector-emitter saturation voltage	$I_C = 100\text{ mA}; I_B = 1\text{ mA}$	-	35	55	mV	
		$I_C = 500\text{ mA}; I_B = 50\text{ mA}$	[1]	-	70	95	mV
		$I_C = 1\text{ A}; I_B = 50\text{ mA}$	[1]	-	145	180	mV
		$I_C = 1\text{ A}; I_B = 100\text{ mA}$	[1]	-	140	175	mV
		$I_C = 2\text{ A}; I_B = 100\text{ mA}$	[1]	-	275	355	mV
		$I_C = 2\text{ A}; I_B = 200\text{ mA}$	[1]	-	270	350	mV
R_{CEsat}	collector-emitter saturation resistance	$I_C = 1\text{ A}; I_B = 100\text{ mA}$	[1]	-	140	$\text{m}\Omega$	
V_{BEsat}	base-emitter saturation voltage	$I_C = 1\text{ A}; I_B = 50\text{ mA}$	[1]	-	0.95	1.1	V
		$I_C = 1\text{ A}; I_B = 100\text{ mA}$	[1]	-	1	1.2	V
V_{BEon}	base-emitter turn-on voltage	$V_{CE} = 5\text{ V}; I_C = 1\text{ A}$	-	0.8	1.1	V	
t_d	delay time	$I_C = 1\text{ A}; I_{B(on)} = 50\text{ mA}; I_{B(off)} = -50\text{ mA}$	-	9	-	ns	
t_r	rise time		-	29	-	ns	
t_{on}	turn-on time		-	38	-	ns	
t_s	storage time		-	200	-	ns	
t_f	fall time		-	40	-	ns	
t_{off}	turn-off time		-	240	-	ns	
f_T	transition frequency	$V_{CE} = 10\text{ V}; I_C = 50\text{ mA}; f = 100\text{ MHz}$	-	210	-	MHz	
C_c	collector capacitance	$V_{CB} = 10\text{ V}; I_E = I_e = 0\text{ A}; f = 1\text{ MHz}$	-	11	-	pF	

[1] Pulse test: $t_p \leq 300\text{ }\mu\text{s}; \delta \leq 0.02$.

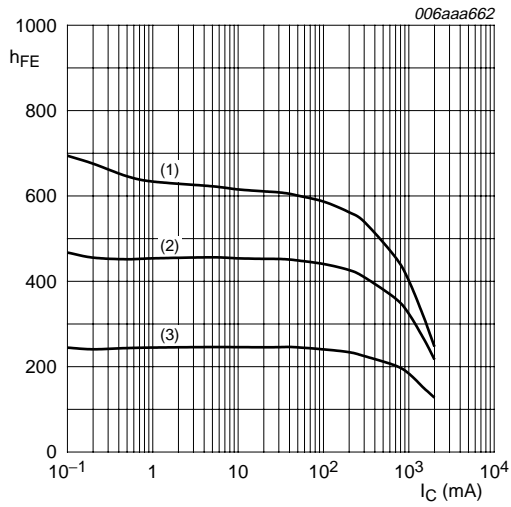

$V_{CE} = 2\text{ V}$
 (1) $T_{amb} = 100\text{ }^\circ\text{C}$
 (2) $T_{amb} = 25\text{ }^\circ\text{C}$
 (3) $T_{amb} = -55\text{ }^\circ\text{C}$

Fig 3. DC current gain as a function of collector current; typical values

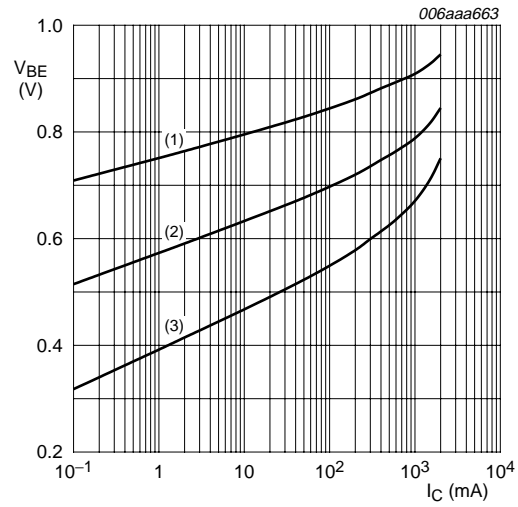

$V_{CE} = 5\text{ V}$
 (1) $T_{amb} = -55\text{ }^\circ\text{C}$
 (2) $T_{amb} = 25\text{ }^\circ\text{C}$
 (3) $T_{amb} = 100\text{ }^\circ\text{C}$

Fig 4. Base-emitter voltage as a function of collector current; typical values

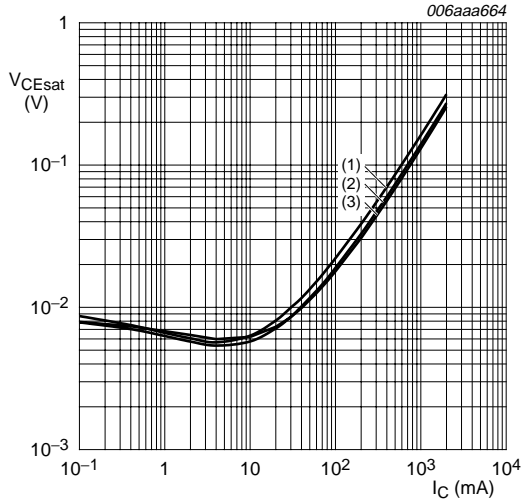

$I_C/I_B = 20$
 (1) $T_{amb} = 100\text{ }^\circ\text{C}$
 (2) $T_{amb} = 25\text{ }^\circ\text{C}$
 (3) $T_{amb} = -55\text{ }^\circ\text{C}$

Fig 5. Collector-emitter saturation voltage as a function of collector current; typical values

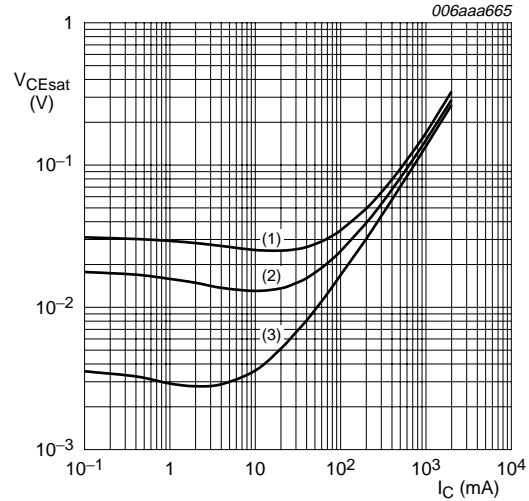

$T_{amb} = 25\text{ }^\circ\text{C}$
 (1) $I_C/I_B = 100$
 (2) $I_C/I_B = 50$
 (3) $I_C/I_B = 10$

Fig 6. Collector-emitter saturation voltage as a function of collector current; typical values

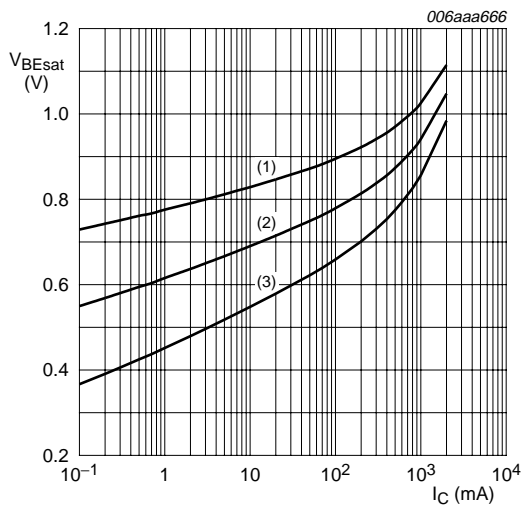

$I_C/I_B = 20$
 (1) $T_{amb} = -55\text{ °C}$
 (2) $T_{amb} = 25\text{ °C}$
 (3) $T_{amb} = 100\text{ °C}$

Fig 7. Base-emitter saturation voltage as a function of collector current; typical values

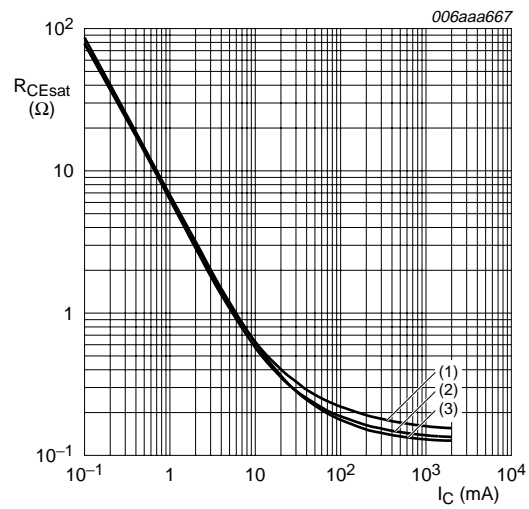

$I_C/I_B = 20$
 (1) $T_{amb} = 100\text{ °C}$
 (2) $T_{amb} = 25\text{ °C}$
 (3) $T_{amb} = -55\text{ °C}$

Fig 8. Collector-emitter saturation resistance as a function of collector current; typical values

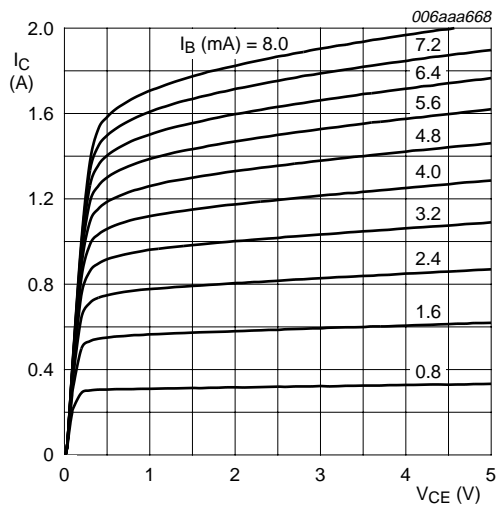

$T_{amb} = 25\text{ °C}$

Fig 9. Collector current as a function of collector-emitter voltage; typical values

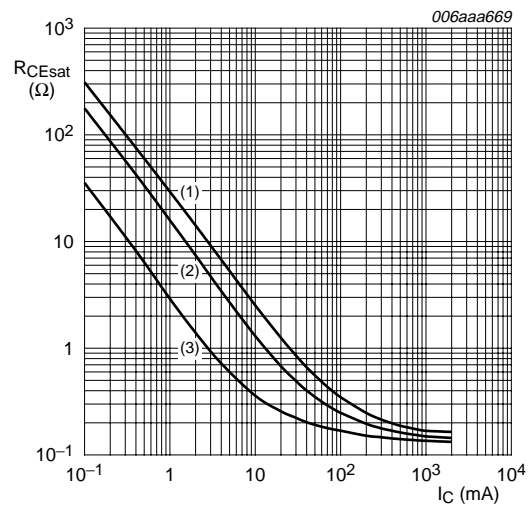

$T_{amb} = 25\text{ °C}$
 (1) $I_C/I_B = 100$
 (2) $I_C/I_B = 50$
 (3) $I_C/I_B = 10$

Fig 10. Collector-emitter saturation resistance as a function of collector current; typical values

8. Test information

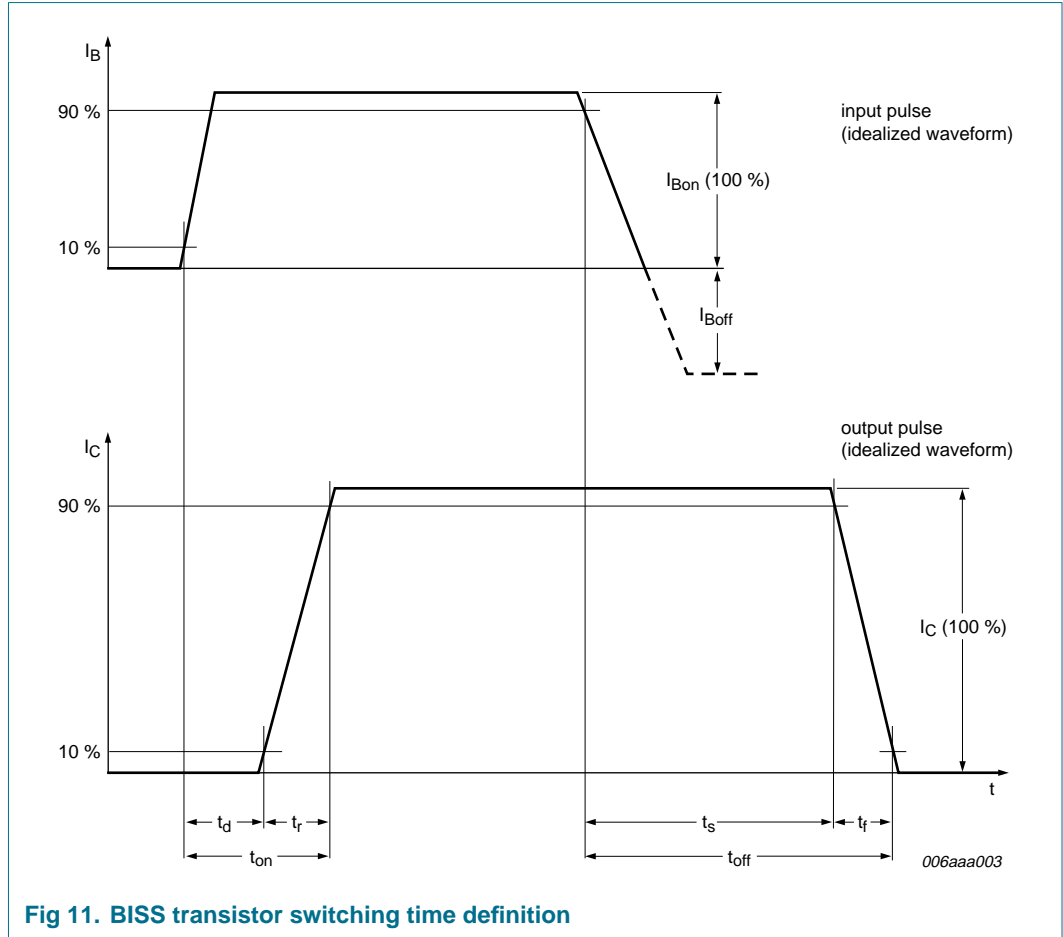
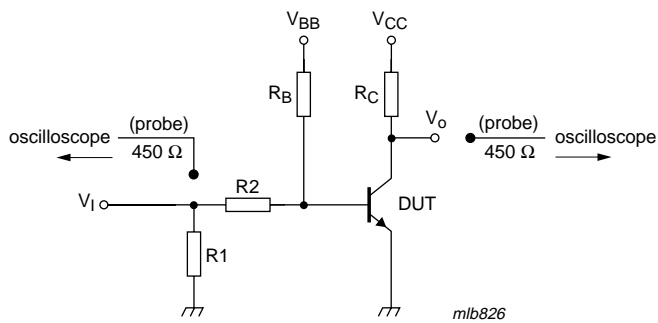

Fig 11. BISS transistor switching time definition



$I_C = 1\text{ A}$; $I_{B_{on}} = 50\text{ mA}$; $I_{B_{off}} = -50\text{ mA}$; $R_1 = \text{open}$; $R_2 = 45\ \Omega$; $R_B = 145\ \Omega$; $R_C = 10\ \Omega$

Fig 12. Test circuit for switching times

9. Package outline

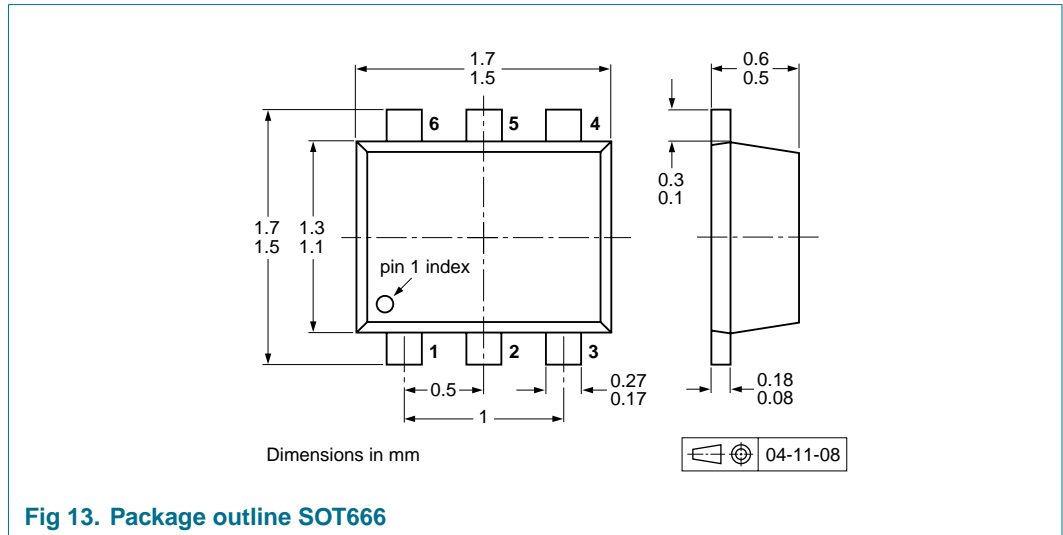

10. Packing information

Table 8: Packing methods

The indicated -xxx are the last three digits of the 12NC ordering code. [\[1\]](#)

Type number	Package	Description	Packing quantity	
			4000	8000
PBSS4220V	SOT666	2 mm pitch, 8 mm tape and reel	-	-315
		4 mm pitch, 8 mm tape and reel	-115	-

[1] For further information and the availability of packing methods, see [Section 17](#).

11. Soldering

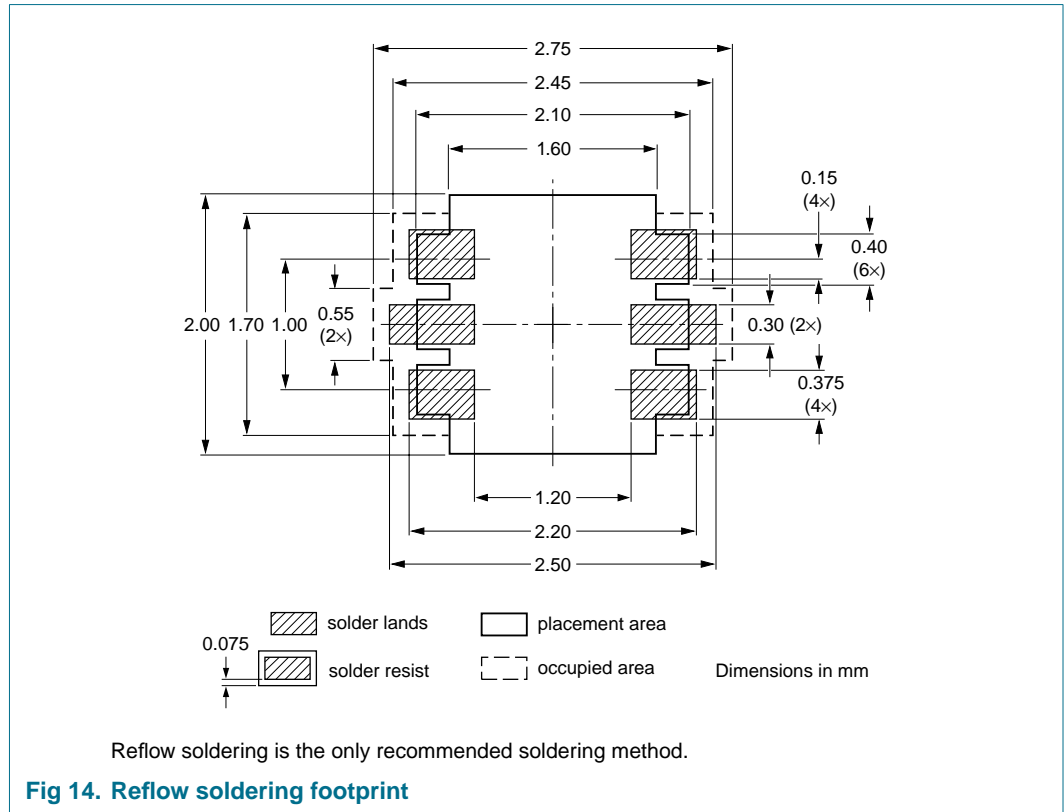

12. Revision history

Table 9: Revision history

Document ID	Release date	Data sheet status	Change notice	Doc. number	Supersedes
PBSS4220V_1	20060206	Product data sheet	-	-	-

13. Data sheet status

Level	Data sheet status ^[1]	Product status ^{[2] [3]}	Definition
I	Objective data	Development	This data sheet contains data from the objective specification for product development. Philips Semiconductors reserves the right to change the specification in any manner without notice.
II	Preliminary data	Qualification	This data sheet contains data from the preliminary specification. Supplementary data will be published at a later date. Philips Semiconductors reserves the right to change the specification without notice, in order to improve the design and supply the best possible product.
III	Product data	Production	This data sheet contains data from the product specification. Philips Semiconductors reserves the right to make changes at any time in order to improve the design, manufacturing and supply. Relevant changes will be communicated via a Customer Product/Process Change Notification (CPCN).

[1] Please consult the most recently issued data sheet before initiating or completing a design.

[2] The product status of the device(s) described in this data sheet may have changed since this data sheet was published. The latest information is available on the Internet at URL <http://www.semiconductors.philips.com>.

[3] For data sheets describing multiple type numbers, the highest-level product status determines the data sheet status.

14. Definitions

Short-form specification — The data in a short-form specification is extracted from a full data sheet with the same type number and title. For detailed information see the relevant data sheet or data handbook.

Limiting values definition — Limiting values given are in accordance with the Absolute Maximum Rating System (IEC 60134). Stress above one or more of the limiting values may cause permanent damage to the device. These are stress ratings only and operation of the device at these or at any other conditions above those given in the Characteristics sections of the specification is not implied. Exposure to limiting values for extended periods may affect device reliability.

Application information — Applications that are described herein for any of these products are for illustrative purposes only. Philips Semiconductors makes no representation or warranty that such applications will be suitable for the specified use without further testing or modification.

customers using or selling these products for use in such applications do so at their own risk and agree to fully indemnify Philips Semiconductors for any damages resulting from such application.

Right to make changes — Philips Semiconductors reserves the right to make changes in the products - including circuits, standard cells, and/or software - described or contained herein in order to improve design and/or performance. When the product is in full production (status 'Production'), relevant changes will be communicated via a Customer Product/Process Change Notification (CPCN). Philips Semiconductors assumes no responsibility or liability for the use of any of these products, conveys no license or title under any patent, copyright, or mask work right to these products, and makes no representations or warranties that these products are free from patent, copyright, or mask work right infringement, unless otherwise specified.

16. Trademarks

Notice — All referenced brands, product names, service names and trademarks are the property of their respective owners.

15. Disclaimers

Life support — These products are not designed for use in life support appliances, devices, or systems where malfunction of these products can reasonably be expected to result in personal injury. Philips Semiconductors

17. Contact information

For additional information, please visit: <http://www.semiconductors.philips.com>

For sales office addresses, send an email to: sales.addresses@www.semiconductors.philips.com

18. Contents

1	Product profile	1
1.1	General description.	1
1.2	Features	1
1.3	Applications	1
1.4	Quick reference data.	1
2	Pinning information	2
3	Ordering information	2
4	Marking	2
5	Limiting values	2
6	Thermal characteristics	4
7	Characteristics	5
8	Test information	8
9	Package outline	9
10	Packing information	9
11	Soldering	10
12	Revision history	11
13	Data sheet status	12
14	Definitions	12
15	Disclaimers	12
16	Trademarks	12
17	Contact information	12



© Koninklijke Philips Electronics N.V. 2006

All rights are reserved. Reproduction in whole or in part is prohibited without the prior written consent of the copyright owner. The information presented in this document does not form part of any quotation or contract, is believed to be accurate and reliable and may be changed without notice. No liability will be accepted by the publisher for any consequence of its use. Publication thereof does not convey nor imply any license under patent- or other industrial or intellectual property rights.

Date of release: 6 February 2006
Document number: PBSS4220V_1

Published in The Netherlands