

Features

- Single power can operate at 2.4V through 6V.
- current output can drive 8 ohm speaker with a transistor.
- Total maximum duration is 2.8 seconds. Speech + mute is about 21.8 seconds.
- Automatic power down.
- Repeat function that can repeat up to 8 times.
- CDS interface is provided.
- It can not trigger itself by stop pulse.
- Mask option for either level or edge trigger type.
- Mask option for LED flasher, BUSY output or STOP pulse output.
- Mask option for either long (20ms) or short (5ms) debounce time.
- Mask option for either holdable output or not.
- Mask option for either fixed (6Hz) or dynamic type on LED flasher.
- Mask option for either retrigger or not.

General Description

The MSS0287 is a single-chip CMOS LSI that memorizes voice up to 2.8 seconds using the MOSEL qualified coding method (MPCM). The chip contains most of the necessary circuit like oscillator, PLA, D/A converter, buzzer buffer, control and timing logic. Therefore, it can apply to various voice systems with minimum external parts. Several device can be combined to reach longer voice duration (longer than 2.8 seconds). Customer speech data will be edited and programmed into PLA by changing one mask during the device fabrication.

Block Diagram

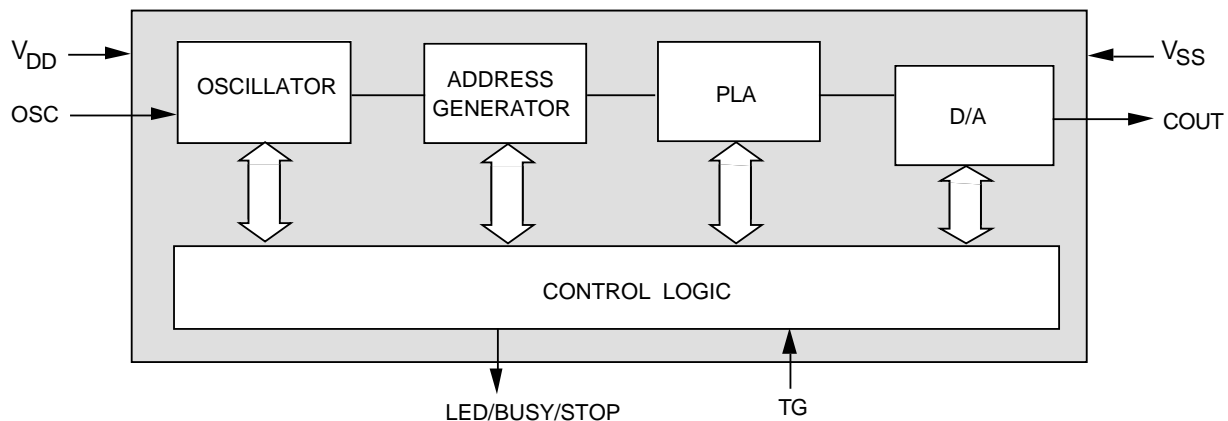

Absolute Maximum Rating

Symbol	Rating	Unit
$V_{DD} \sim V_{SS}$	-0.5 ~ +7.0	V
V_{IN} (TG)	$V_{SS} - 0.3 < V_{IN} < V_{DD} + 0.3$	V
V_{OUT} (STOP)	$V_{SS} < V_{OUT} < V_{DD}$	V
T (Operating)	-10 ~ +60	°C
T (Storage)	-55 ~ +125	°C

Pad Description

Pad No.	Signal Name	I/O	Function
1	V_{DD}	Power	Positive power supply
2	OSC	I	Oscillator resistor input
3	Reserved	NC	Reserved no Connection
4	LED/BUSY/STOP	O	LED flasher output/BUSY signal output/One shot stop signal output.
5	TG	I	Trigger input, active high
6	C_{OUT}	O	Current output for driving speaker
7	V_{SS}	Power	Negative power supply

DC Characteristics

Symbol	Parameter		Min.	Typ.	Max.	Unit	Condition
I_{SB}	Supply	Stand by	—	—	1	μA	$V_{DD} = 4.5V$, I/O Open
I_{OP}	Current	Operating	—	—	200		
I_{IH}	Input Current (TG)		—	—	+15	μA	$V_{DD} = 4.5V$
I_{IL}			—	0	—		
I_{OC}	Output Current (C_{OUT})		—	5	—	mA	$V_{DD} = 3V$, full scale.
I_{BZ}	Output Current (BUSY)		—	-9	—	mA	$V_{DD} = 4.5V$,
I_{STOP}	Output Current (STOP)		—	-9	—	mA	$V_{DD} = 4.5V$,
I_{OH}	Output Current (LED)		—	-8	—	mA	$V_{DD} = 4.5V$, $V_{OP} = V_{OH}$
I_{OL}			—	+8	—		$V_{DD} = 4.5V$, $V_{OP} = V_{OL}$
$\Delta F/F$	Frequency Stability		—	—	± 5	%	$\frac{F_{osc}(4.5V) - F_{osc}(4V)}{F_{osc}(4.5V)}$
$\Delta F/F$	Frequency Variation		—	—	± 10	%	$V_{DD} = 4.5V$, $R_{osc} = 1.2M\Omega$

AC Characteristics

Symbol	Parameter	Min.	Typ.	Max.	Unit	Condition
T_{STOP}	Pulse Width (STOP)	—	40	—	ms	$V_{DD} = 4.5V$
T_T	Minimal trigger pulse width	—	20	—	ms	Mask = long
		—	5	—		Mask = short

Timing Diagram

I. Edge Trigger Mask

I.1. Unholdable output with BUSY output

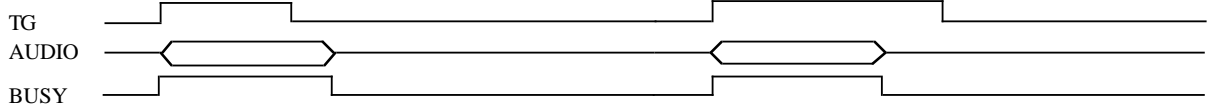

I.2. Unholdable output with STOP Pulse

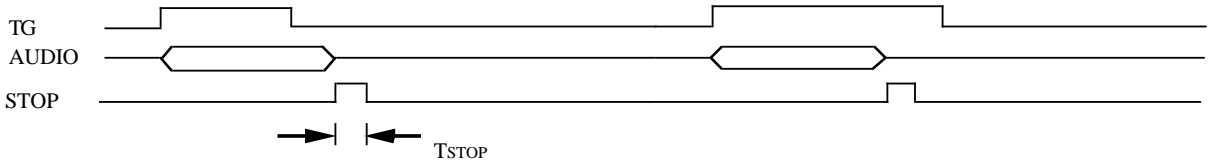

I.3. Unholdable output with Fixed-Type LED Flasher

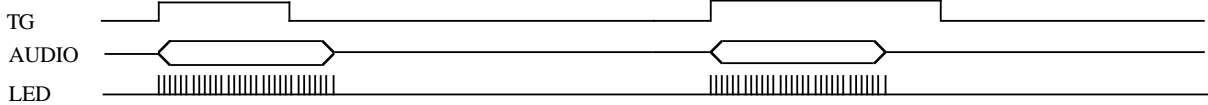

I.4. Unholdable output with Dynamic-Type LED Flasher

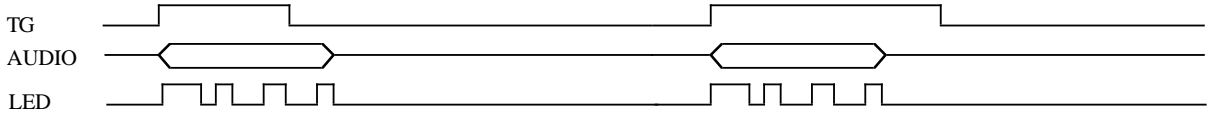

I.5. Holdable output with BUSY output

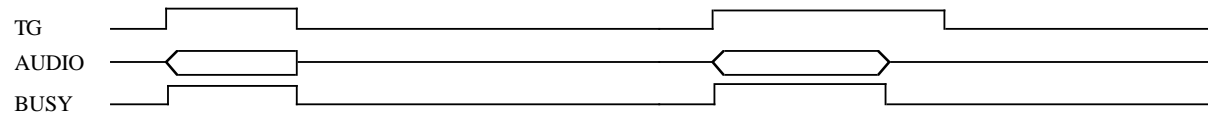

I.6. Holdable output with STOP Pulse

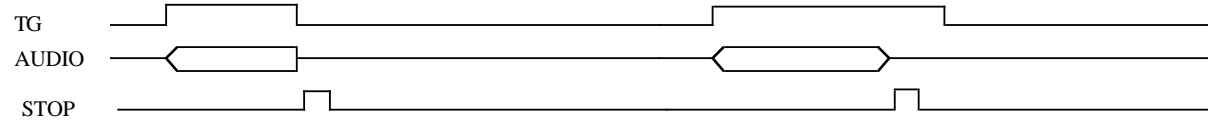

I.7. Holdable output with Fixed-Type LED Flasher

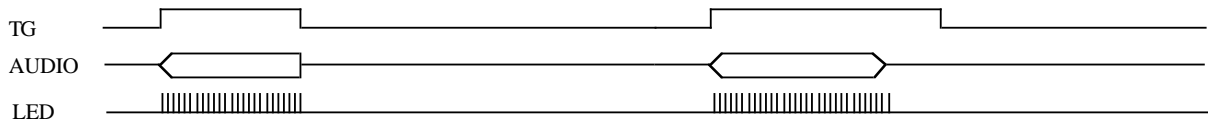

I.8. Holdable output with Dynamic-Type LED Flasher

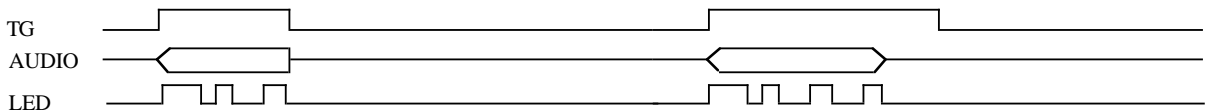

II. Level Trigger Mask

II.1. Unholdable output with BUSY output

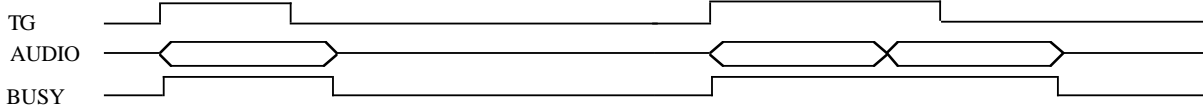

II.2. Unholdable output with Stop Pulse

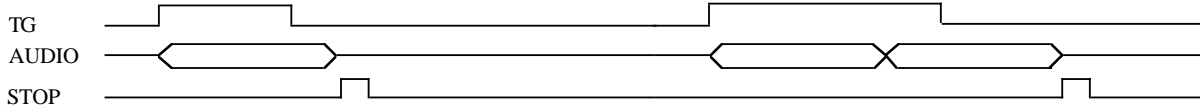

II.3. Unholdable output with Fixed-Type LED Flasher

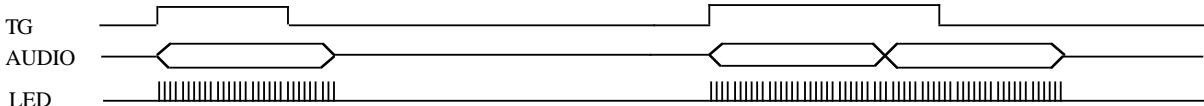

II.4. Unholdable output with Dynamic-Type LED Flasher

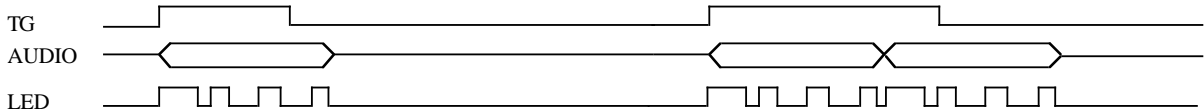

II.5. Holdable output with BUSY output

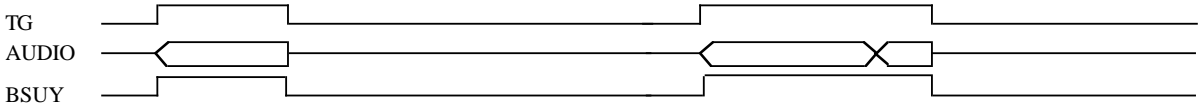

II.6. Holdable output with Stop Pulse

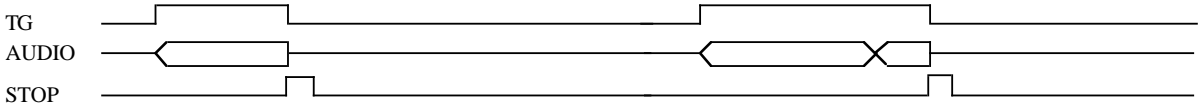

II.7. Holdable output with Fixed-Type LED Flasher

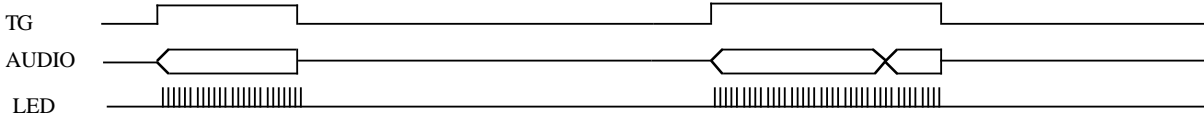

II.8. Holdable output with Dynamic-Type LED Flasher

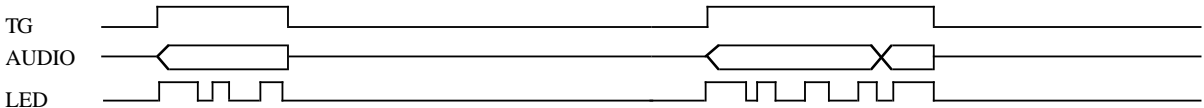

III. Debounce Time

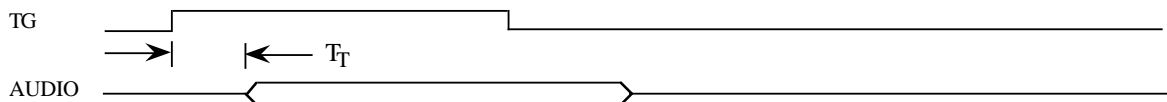

Application Circuit

1. Typical application

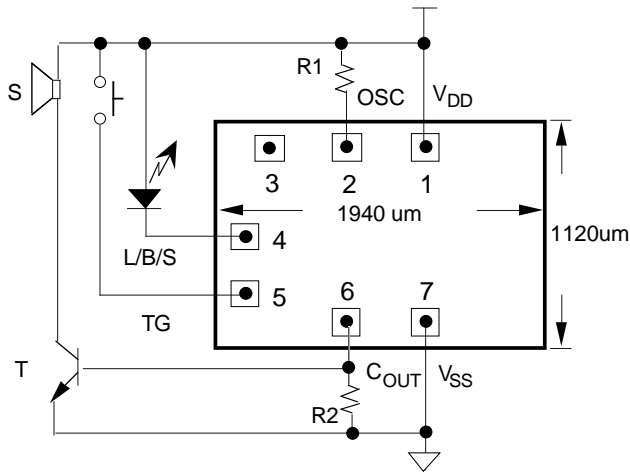

Pin No.	Designation	X	Y
1	V _{DD}	-366.3	-19.6
2	OSC	-358.3	-340.8
3	NC	-358.3	-677.2
4	L/B/S	13	-769.2
5	TG	266	-769.2
6	C _{OUT}	358.3	-233.0
7	V _{SS}	366.3	-21.8

Note: Substrate is V_{DD}

PAD SIZE =90 X 90 um

2. CDS application

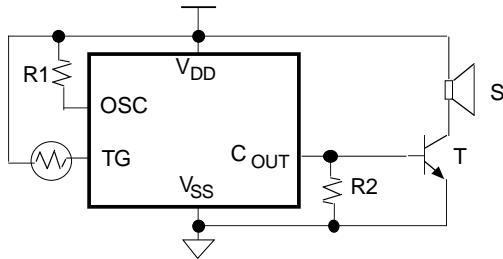

3. Power on play

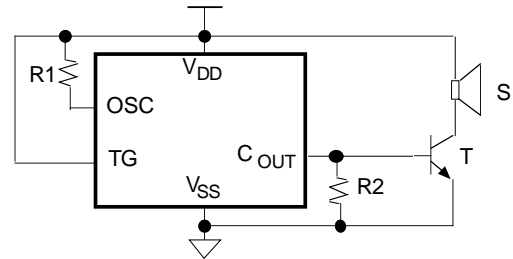

- Note: a. R1 =1.2MΩ (S.R.=6KHz) , T (transistor) = β > 150 ,S (speaker) =1/4W ,8Ω ; all typical.
 b. R2=470Ω (typical) to bypass extra current into base to get rid of waveform saturation on collector .
 c. In order to avoid false (or noise) trigger.
 1. To minimize the routing of trigger signal.
 2. The routing of trigger signal should be as far away as possible to speaker signal.