

General Description

The AAT3140 is a low noise, constant frequency charge pump DC/DC converter that uses a tri-mode load switch (1X), fractional (1.5X), and doubling (2X) conversion to maximize efficiency for white LED applications. The device produces current levels up to 30mA on each of its four current source outputs to drive various arrangements of LEDs from a 2.7V to 5.5V input. Outputs may be operated individually or in parallel for driving higher-current LEDs. A low external parts count (two 1 μ F flying capacitors and two small 1 μ F capacitors at V_{IN} and CP) make the AAT3140 ideally suited for small battery-powered applications.

The AAT3140 is equipped with AnalogicTech's unique AutoBias™ technology which allows individual LEDs to be powered either by charge pump or battery input, determined internally and automatically to maximize the power efficiency even with a large difference in LED forward voltage.

AnalogicTech's Simple Serial Control™ (S²Cwire™) digital input is used to enable, disable, and set the LED drive current with a 32-level logarithmic scale LED brightness control. The AAT3140 has a thermal management system to protect the device in the event of a short-circuit condition at an output pin. Built-in soft-start circuitry prevents excessive inrush current during start-up. A high charge pump switching frequency enables the use of very small external capacitors. In shutdown mode, the device disconnects the load from V_{IN} and reduces quiescent current to less than 1 μ A. The AAT3140 is available in the very small 12-pin TSOPJW package.

Features

- V_{IN} Range: 2.7V to 5.5V
- Tri-Mode 1X, 1.5X, and 2X Charge Pump for Maximum Efficiency and V_F Coverage
- Drives Low- V_F and High- V_F Type LEDs
- Up to 4, 30mA Outputs
- 32-Position Logarithmic Scale with Digital Control
- Low Noise Constant Frequency Operation
- 1MHz Switching Frequency
- AutoBias Technology
- Small Application Circuit
- Regulated Output Current
- Automatic Soft Start
- No Inductors
- $I_Q < 1\mu A$ in Shutdown
- 12-Pin TSOPJW Package

Applications

- Color (RGB) Lighting
- Programmable Current Sources
- White LED Backlighting
- White Photo Flash for DSCs

Typical Application

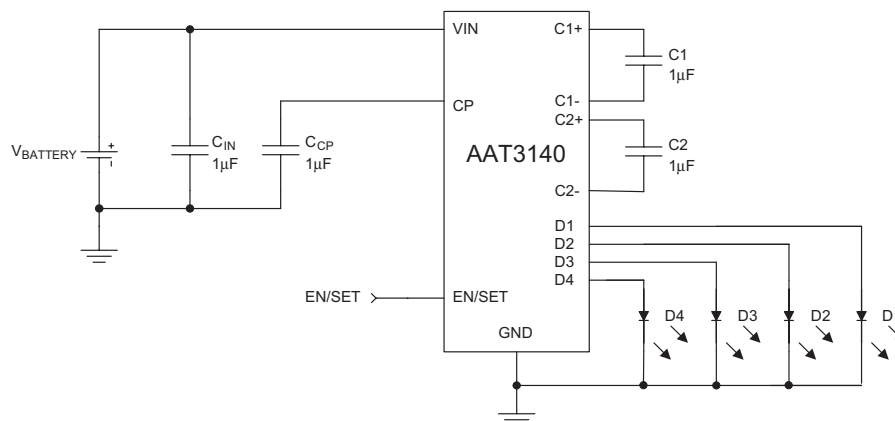

Pin Descriptions

Pin #	Symbol	Function
1	C2+	Flying capacitor 2 positive terminal. Connect a 1 μ F capacitor between C2+ and C2-.
2	CP	Charge pump output. Requires 1 μ F capacitor connected between this pin and ground.
3	C1-	Flying capacitor 1 negative terminal.
4	C1+	Flying capacitor 1 positive terminal. Connect a 1 μ F capacitor between C1+ and C1-.
5	D3	Current source output #3.
6	D2	Current source output #2.
7	D4	Current source output #4.
8	D1	Current source output #1.
9	EN/SET	S ² Cwire serial interface control pin.
10	IN	Input power supply. Requires 1 μ F capacitor connected between this pin and ground.
11	GND	Ground.
12	C2-	Flying capacitor 2 negative terminal.

Pin Configuration

**TSOPJW-12
(Top View)**

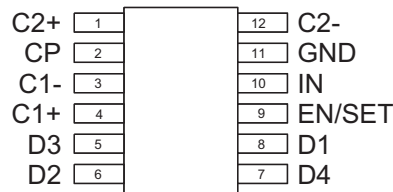

Absolute Maximum Ratings¹

Symbol	Description	Value	Units
V_{IN}	Input Voltage	-0.3 to 6	V
$V_{EN/SET}$	EN/SET to GND Voltage	-0.3 to $V_{IN} + 0.3$	V
I_{OUT}^2	Maximum DC Output Current	150	mA
T_J	Operating Junction Temperature Range	-40 to 150	°C

Thermal Information

Symbol	Description	Value	Units
P_D	Maximum Power Dissipation ^{3,4}	625	mW
θ_{JA}	Thermal Resistance ³	160	°C/W

1. Stresses above those listed in Absolute Maximum Ratings may cause permanent damage to the device. Functional operation at conditions other than the operating conditions specified is not implied. Only one Absolute Maximum Rating should be applied at any one time.
2. Based on long-term current density limitation.
3. Mounted on an FR4 board.
4. Derate 6.25mW/°C above 25°C.

Electrical Characteristics¹

$C_{IN} = C_{CP} = C1 = C2 = 1.0\mu\text{F}$; $T_A = -40^\circ\text{C}$ to $+85^\circ\text{C}$, unless otherwise noted. Typical values are at $T_A = 25^\circ\text{C}$, $V_{IN} = 3.5\text{V}$.

Symbol	Description	Conditions	Min	Typ	Max	Units
Input Power Supply						
V_{IN}	Operation Range		2.7		5.5	V
I_{CC}	Operating Current	VD1:D4 = 2.0V, CP = 1X		550		μA
		No Load Current, CP = 1.5X		3	5	mA
I_{SHDN}	Shutdown Current	$V_{IN} = 3.5\text{V}$, EN/SET = 0			1	μA
I_{DX}	Output Current Accuracy ²	$V_{IN} = 3.5\text{V}$, $T_A = 25^\circ\text{C}$	-10		10	%
$I_{(D-Match)}$	Current Matching ³	VD1:D4 = 3.6V, $V_{IN} = 3.5\text{V}$	-3	± 0.5	3	%
η_{CP}	Charge Pump Section Efficiency	$V_{IN} = 3.5\text{V}$, $I_{OUT(TOTAL)} = 120\text{mA}$, Measured from IN to CP		93		%
Charge Pump Section						
T_{SS}	Soft-Start Time			50		μs
F_{CLK}	Clock Frequency			1		MHz
EN/SET						
$V_{EN(L)}$	Enable Threshold Low	$V_{IN} = 2.7\text{V}$			0.4	V
$V_{EN(H)}$	Enable Threshold High	$V_{IN} = 5.5\text{V}$	1.4			V
$T_{EN/SET LO}$	EN/SET Low Time		0.3		75	μs
$T_{EN/SET HI MIN}$	Minimum EN/SET High Time			50		ns
$T_{EN/SET HI MAX}$	Maximum EN/SET High Time				75	μs
T_{OFF}	EN/SET Off Timeout				500	μs
T_{LAT}	EN/SET Latch Timeout				500	μs
$I_{EN/SET}$	EN/SET Input Leakage	$V_{EN/SET} = 5.5\text{V}$, $V_{IN} = 5.5\text{V}$	-1		1	μA

1. The AAT3140 is guaranteed to meet performance specifications over the -40°C to $+85^\circ\text{C}$ operating temperature range and is assured by design, characterization, and correlation with statistical process controls.

2. Codes 2-7 are guaranteed to be within $\pm 15\%$ of stated current level.

3. Current matching is defined as $I_{(D-Match)} = (I_D - I_{AVE})/I_{AVE}$.

Typical Characteristics

$V_{IN} = 3.5V$, $C_{IN} = C_{CP} = C1 = C2 = 1\mu F$, $T_A = 25^\circ C$, unless otherwise noted.

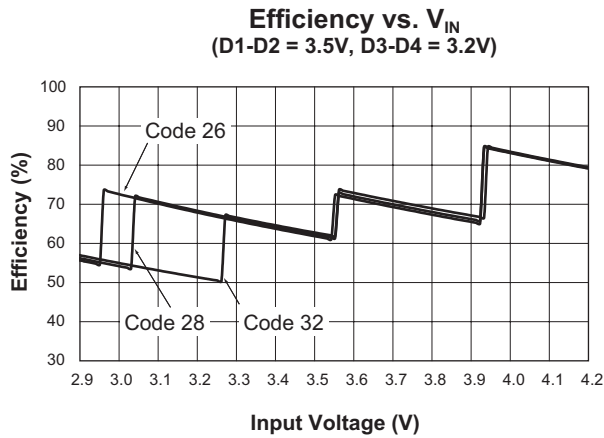
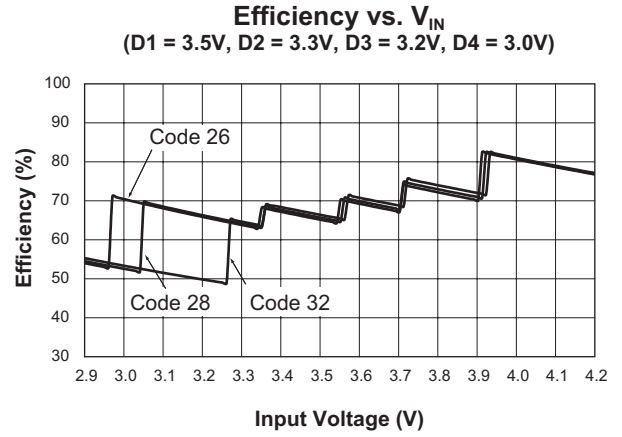
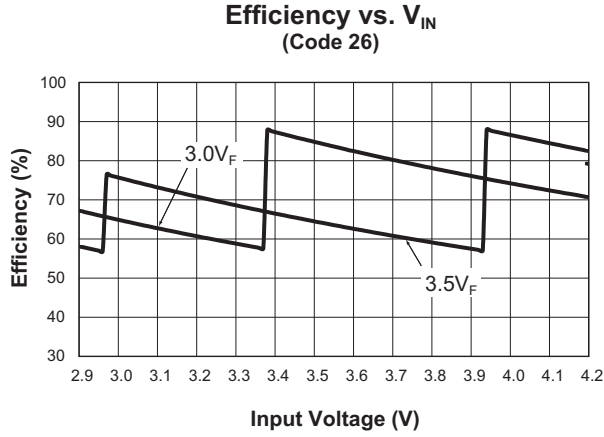

Typical Characteristics

$V_{IN} = 3.5V$, $C_{IN} = C_{CP} = C1 = C2 = 1\mu F$, $T_A = 25^\circ C$, unless otherwise noted.

Turn-On to 1X Mode
(4x19mA Load)

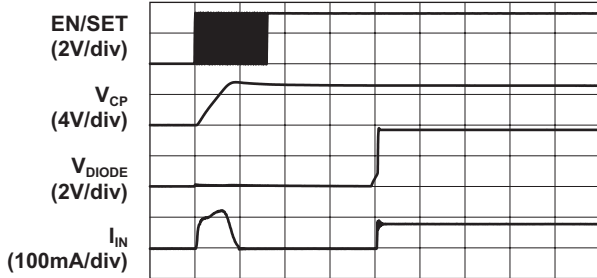

100 μ s/div

Turn-On to 1X Mode
(4x30mA Load)

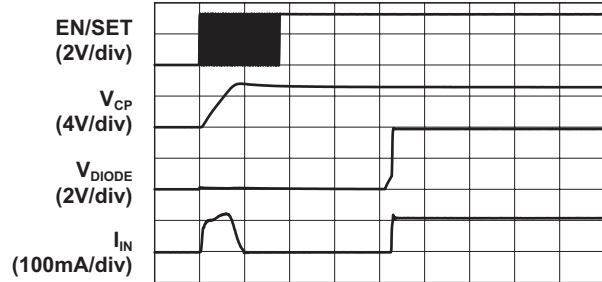

100 μ s/div

Turn-On to 1.5X Mode
(4x19mA Load)

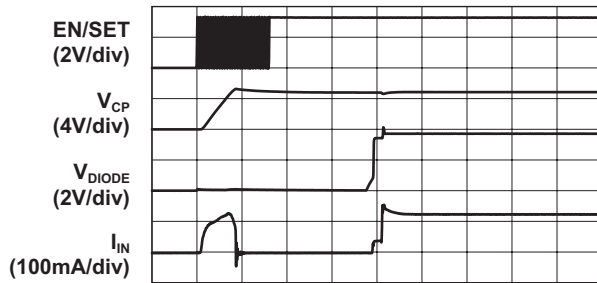

100 μ s/div

Turn-On to 1.5X Mode
(4x30mA Load)

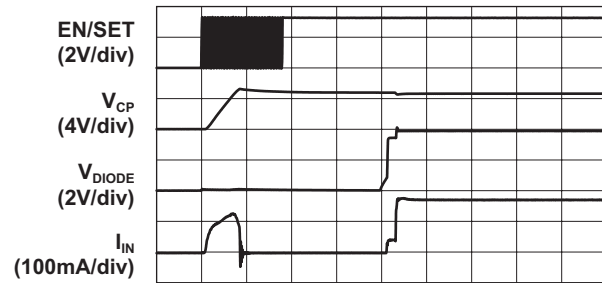

100 μ s/div

Turn-Off from Full-Scale 2X Mode

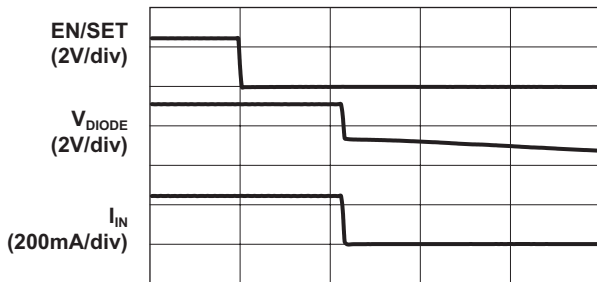

100 μ s/div

Typical Characteristics

$V_{IN} = 3.5V$, $C_{IN} = C_{CP} = C1 = C2 = 1\mu F$, $T_A = 25^\circ C$, unless otherwise noted.

Charge Pump to Load Switch
(1.5X Mode, 4x19mA Load)

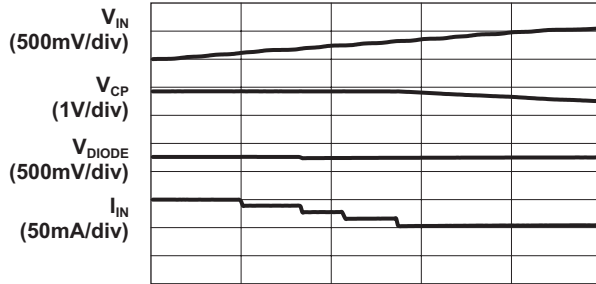

5ms/div

Charge Pump to Load Switch
(1.5X Mode, 4x30mA Load)

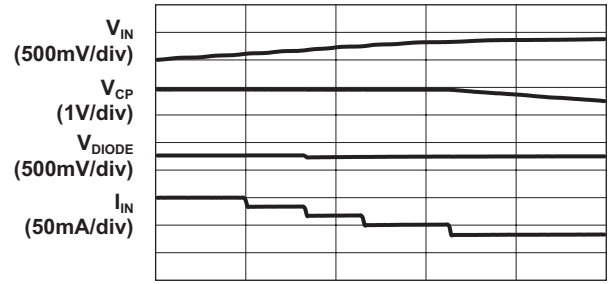

5ms/div

Charge Pump to Load Switch
(2X Mode, 4x19mA Load)

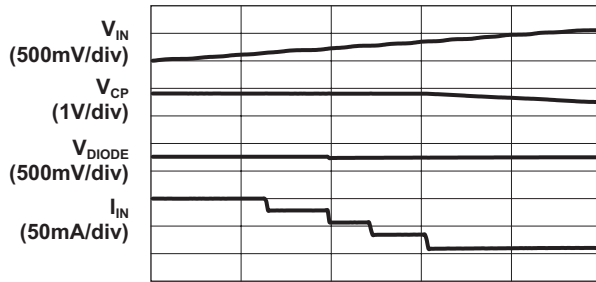

5ms/div

Charge Pump to Load Switch
(2X Mode, 4x30mA Load)

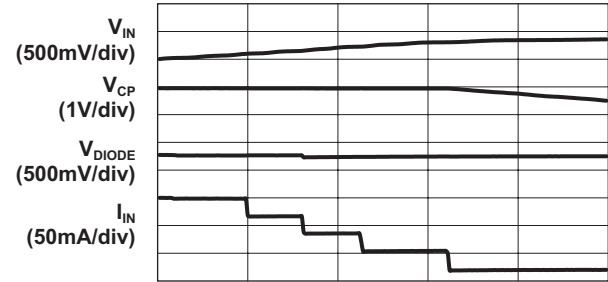

5ms/div

Load Switch to Charge Pump
(1.5X Mode, 4x19mA Load)



2ms/div

Load Switch to Charge Pump
(1.5X Mode, 4x30mA Load)

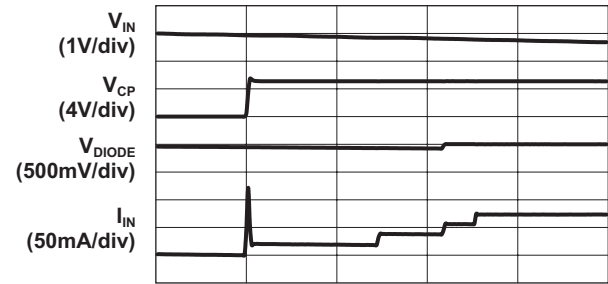

2ms/div

Typical Characteristics

$V_{IN} = 3.5V$, $C_{IN} = C_{CP} = C1 = C2 = 1\mu F$, $T_A = 25^\circ C$, unless otherwise noted.

Line Response
(1X Mode, 4x19mA Load)

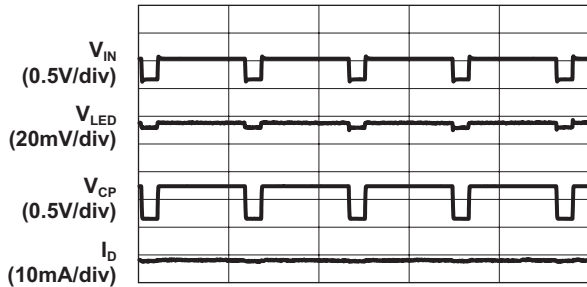

1ms/div

Line Response
(1X Mode, 4x30mA Load)

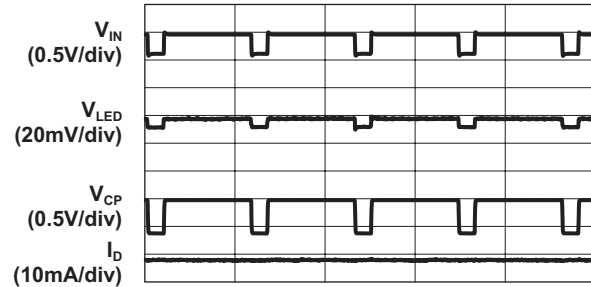

1ms/div

Line Response
(1.5X Mode, 4x19mA Load)

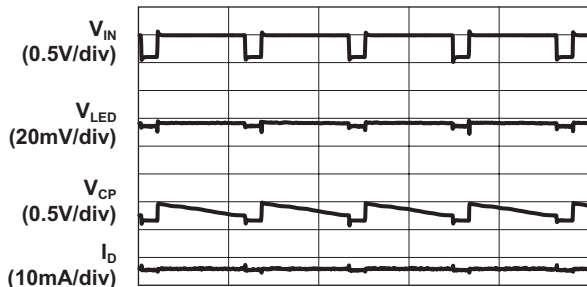

1ms/div

Line Response
(1.5X Mode, 4x30mA Load)

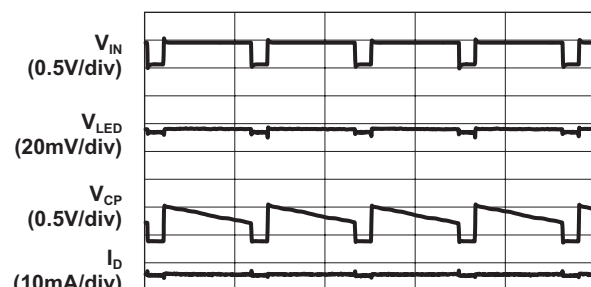

1ms/div

Load Characteristics
(1.5X Mode, 4x15mA Load)

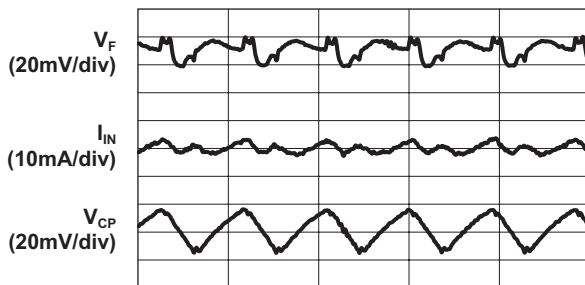

1µs/div

Load Characteristics
(1.5X Mode, 4x30mA Load)

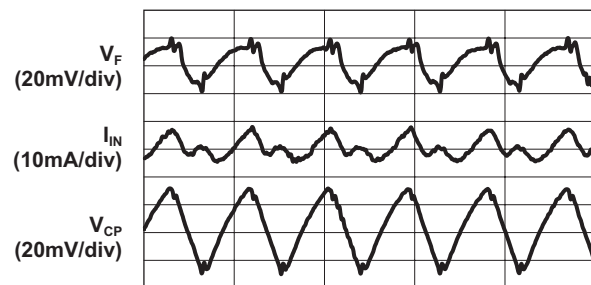

1µs/div

Typical Characteristics

$V_{IN} = 3.5V$, $C_{IN} = C_{CP} = C1 = C2 = 1\mu F$, $T_A = 25^\circ C$, unless otherwise noted.

Input Current vs. Input Voltage
(4x10mA)

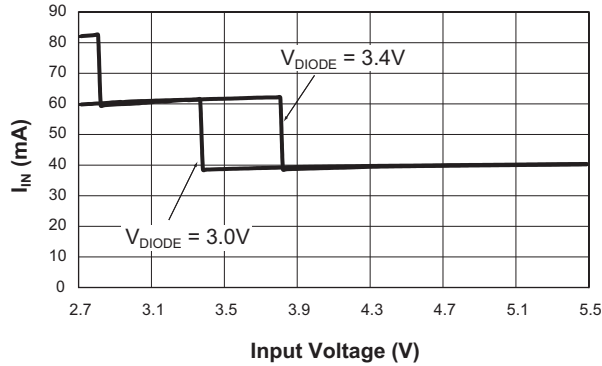

Input Current vs. Input Voltage
(4x30mA)

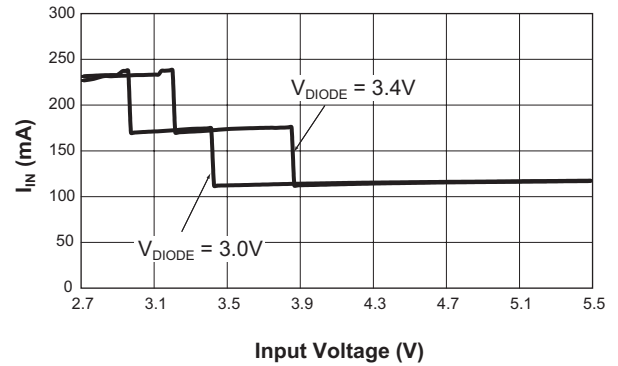

Diode Current vs. Input Voltage
(30mA, 15mA Settings)

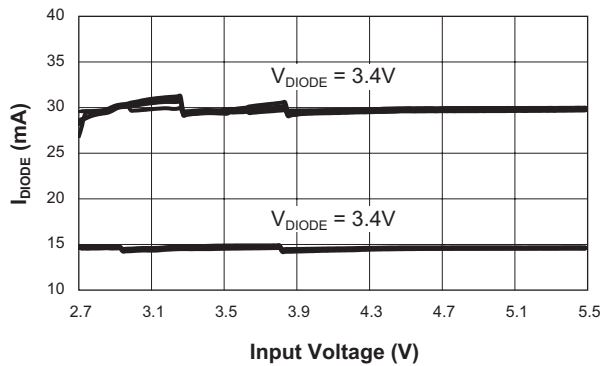

V_{IH} and V_{IL} vs. V_{IN}

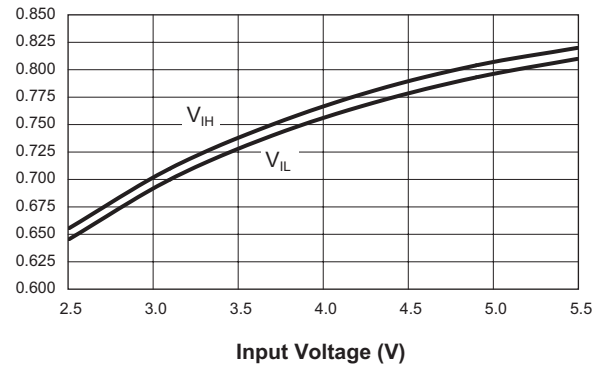

Functional Block Diagram

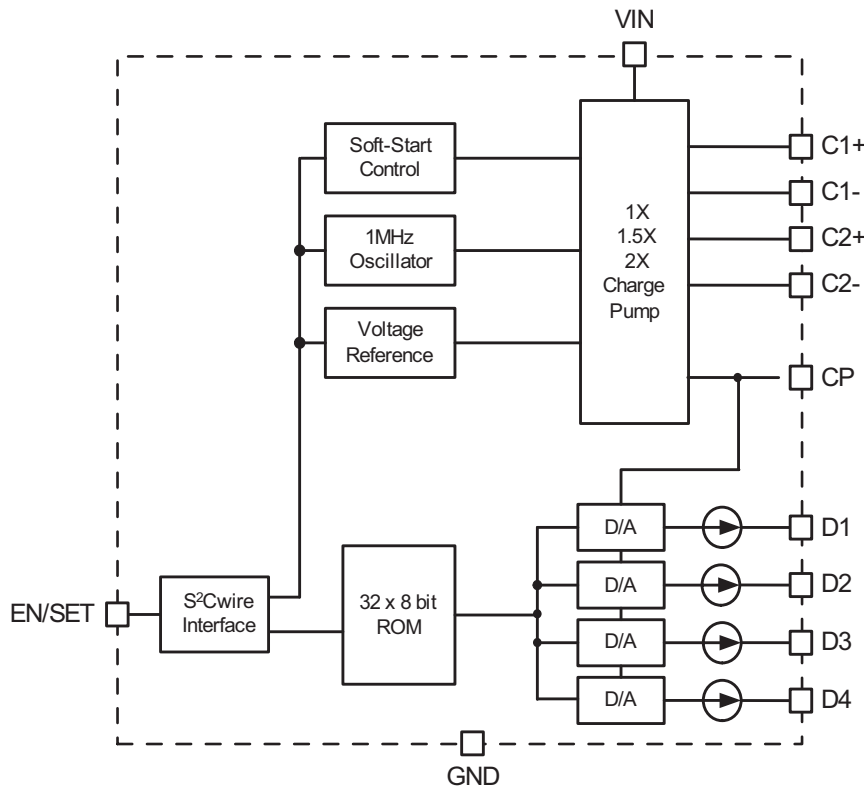

Functional Description

The AAT3140 is a tri-mode load switch (1X) and high-efficiency (1.5X or 2X) charge pump device intended for white LED backlight applications. To maximize power conversion efficiency, an internal sensing circuit monitors the voltage required on each constant current source output and sets the load switch and charge pump modes based on the input battery voltage and the current source output voltage. As the battery discharges over time, the AAT3140 charge pump is enabled when any of the four current source outputs nears dropout. The charge pump initially starts in 1.5X mode. If the charge pump output drops enough for any current source output to become close to dropout, the charge pump will automatically transition to 2X mode.

AutoBias Technology

Each of the four current source outputs is independently switched between the battery input (1X) or the charge pump output (1.5X or 2X), depending on the voltage at the current source output. Since the LED-to-LED forward voltage (V_F) can vary as much as 1 volt, this function significantly enhances overall device efficiency when the battery input voltage level is greater than the voltage required at any current source output.

The AAT3140 requires only four external components: two $1\mu\text{F}$ ceramic capacitors for the charge pump flying capacitors (C1 and C2), one $1\mu\text{F}$ ceramic input capacitor (C_{IN}), and one $0.33\mu\text{F}$ to $1\mu\text{F}$ ceramic charge pump output capacitor (C_{CP}). The four constant current outputs (D1 to D4) drive four individual LEDs with a maximum current of 30mA each. The EN/SET S²Cwire serial interface enables the AAT3140 and sets the current source magnitudes.

Applications Information

Constant Current Output Level Settings

The constant current source amplitudes for D1 to D4 are set via the serial interface according to a logarithmic scale where each code is 1dB greater than the previous code. In this manner, LED brightness appears linear with each increasing code count. Because the outputs D1 to D4 are true independent constant current sources, the voltage observed on any single given output will be determined by the actual forward voltage (V_f) for the LED being driven.

Since the output current of the AAT3140 is programmable, no PWM (pulse width modulation) or additional control circuitry is needed to control LED

brightness. This feature greatly reduces the burden on a microcontroller or system IC to manage LED or display brightness, allowing the user to "set it and forget it." With its high-speed serial interface (1MHz data rate), the output current of the AAT3140 can be changed successively to brighten or dim LEDs, in smooth transitions (e.g., to fade-out) or in abrupt steps, giving the user complete programmability and real-time control of LED brightness.

The individual current level settings are each approximately 1dB apart for settings above Code 8 (see Current Level Settings below). The current level settings below Code 8 are more than 1dB apart and serve the needs for transmissive displays and other low-current applications.

Normalized Current Level Settings

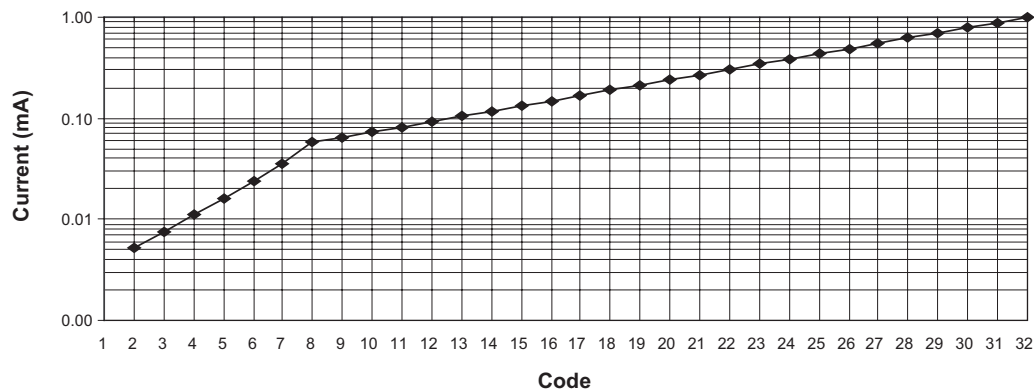

Constant Current Source Output Nominal Programming Levels (mA)

Code	I_{OUT} (typ) (mA)	Code	I_{OUT} (typ) (mA)	Code	I_{OUT} (typ) (mA)	Code	I_{OUT} (typ) (mA)
1	0.0	9	2.0	17	5.1	25	13
2	0.1	10	2.2	18	5.6	26	15
3	0.2	11	2.5	19	6	27	17
4	0.4	12	2.8	20	7	28	19
5	0.5	13	3.2	21	8	29	21
6	0.7	14	3.5	22	9	30	24
7	1.1	15	4.0	23	10	31	27
8	1.8	16	4.5	24	12	32	30

S²Cwire Serial Interface

The current source output magnitude is controlled by the EN/SET pin, using AnalogicTech's Simple Serial Control (S²Cwire) interface. The interface records rising edges of the EN/SET pin, and decodes them into 32 individual current level settings with Code1 reserved for no current. Once EN/SET has been held in the logic high state for time T_{LAT} , the programmed current is seen at the

current source outputs, and the internal data register is reset to 0. For subsequent current level programming, the number of rising edges corresponding to the desired code must be entered on the EN/SET pin.

When EN/SET is held low for an amount of time greater than T_{OFF} , the AAT3140 enters into shutdown mode and draws less than $1\mu A$ from V_{IN} . The internal data register is reset to 0 during shutdown.

S²Cwire Serial Interface Timing

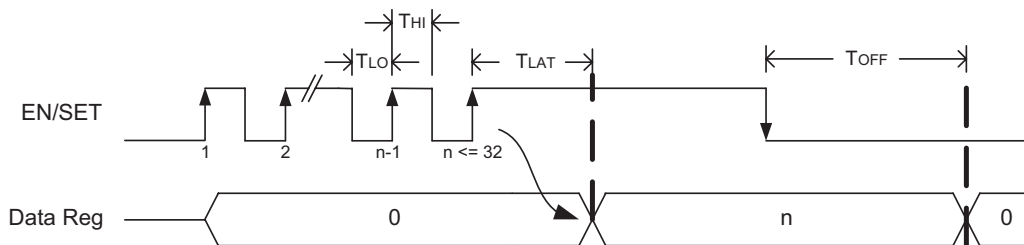

LED Selection

The AAT3140 is specifically intended for driving white LEDs. However, the device design will allow the AAT3140 to drive most types of LEDs with forward voltage specifications ranging from 2.0V to 4.3V. LED applications may include main and sub-LCD display backlighting, camera photo-flash applications, color (RGB) LEDs, infrared (IR) diodes for remotes, and other loads benefiting from a controlled output-current generated from a varying input-voltage. Since the D1 to D4 output current sources are matched with negligible voltage dependence, the LED brightness will be matched regardless of the specific LED forward voltage (V_F) levels.

In some instances (e.g., in high-luminous-output applications such as photo-flash), it may be necessary to drive high- V_F type LEDs. The *low-dropout* current-sources in the AAT3140 make it capable of driving LEDs with forward voltages as high as 4.3V at full current from an input supply as low as 3.0V. Outputs can be paralleled to drive high-current LEDs without complication.

Termination of Unused Current Source Outputs

If any outputs (D1 to D4) are not used, they should be terminated by connecting the respective unused output directly to ground. This is required to assure correct charge pump mode operation. If a given unused output is not terminated to ground, it will appear to the respective output's feedback control as an infinite impedance load and the unused constant current source will be set for a maximum voltage. Although no current flows from the unused current source, the voltage sensed at that node could force the charge pump control to activate the charge pump when it is not necessary. To prevent this effect, simply connect the unused constant current source outputs to ground.

Device Switching Noise Performance

The AAT3140 operates at a fixed frequency of approximately 1MHz to control noise and limit harmonics that can interfere with the RF operation of cellular telephone handsets or other communication

devices. Back-injected noise appearing on the input pin of the charge pump is 20mV peak-to-peak, typically ten times less than inductor-based DC/DC boost converter white LED backlight solutions. The AAT3140 soft-start feature prevents noise transient effects associated with in-rush currents during start up of the charge pump circuit.

Power Efficiency and Device Evaluation

The charge pump efficiency discussion in the following sections only accounts for efficiency of the charge pump section itself. Due to the unique circuit architecture and design of the AAT3140, it is very difficult to measure efficiency in terms of a percent value comparing input power over output power.

Since the AAT3140 outputs are pure constant current sources and typically drive individual loads, it is difficult to measure the output voltage for a given output (D1 to D4) to derive an overall output power measurement. For any given application, white LED forward voltage levels can differ, yet the output drive current will be maintained as a constant.

This makes quantifying output power a difficult task when taken in the context of comparing to other white LED driver circuit topologies. A better way to quantify total device efficiency is to observe the total input power to the device for a given LED current drive level. The best white LED driver for a given application should be based on trade-offs of size, external component count, reliability, operating range, and total energy usage...*not just "% efficiency."*

The AAT3140 efficiency may be quantified under very specific conditions and is dependent upon the input voltage versus the output voltage seen across the loads applied to outputs D1 through D4 for a given constant current setting. Depending upon the case of V_{IN} being greater than the specific voltage seen across the loads on D1 through D4, the device will operate in "Load Switch" mode. If the voltage seen on the constant current source output is less than V_{IN} , then the device will operate in 1.5X or 2X charge pump mode. Each of these modes will yield different efficiency values. Refer to the following two sections for explanations of each operational mode.

Load Switch Mode Efficiency

The AAT3140 load switch mode is operational at all times and functions alone to enhance device power conversion efficiency when the condition exists where V_{IN} is greater than voltage across the load connected to the constant current source outputs. When in load switch mode, the voltage conversion efficiency is defined as output power divided by input power:

$$\eta = \frac{P_{OUT}}{P_{IN}}$$

The expression to define the ideal efficiency (η) can be rewritten as:

$$\eta = \frac{P_{OUT}}{P_{IN}} = \frac{V_{OUT} \times I_{OUT}}{V_{IN} \times I_{OUT}} = \frac{V_{OUT}}{V_{IN}}$$

-or-

$$\eta(\%) = 100 \left(\frac{V_{OUT}}{V_{IN}} \right)$$

Charge Pump Section Efficiency

The AAT3140 contains a fractional charge pump which will boost the input supply voltage in the event where V_{IN} is less than the voltage required on the constant current source outputs. The efficiency (η) can be simply defined as a linear voltage regulator with an effective output voltage that is equal to one and one half or two times the input voltage. Efficiency (η) for an ideal 1.5X charge pump can typically be expressed as the output power divided by the input power:

$$\eta = \frac{P_{OUT}}{P_{IN}}$$

In addition, with an ideal 1.5X charge pump, the output current may be expressed as 2/3 of the input current. The expression to define the ideal efficiency (η) can be rewritten as:

$$\eta = \frac{P_{OUT}}{P_{IN}} = \frac{V_{OUT} \times I_{OUT}}{V_{IN} \times 1.5I_{OUT}} = \frac{V_{OUT}}{1.5V_{IN}}$$

-or-

$$\eta(\%) = 100 \left(\frac{V_{OUT}}{1.5V_{IN}} \right)$$

For a charge pump with an output of 5 volts and a nominal input of 3.5 volts, the theoretical efficiency is 95%. Due to internal switching losses and IC quiescent current consumption, the actual efficiency can be measured at 93%. These figures are in close agreement for output load conditions from 1mA to 100mA. Efficiency will decrease as load current drops below 0.05mA or when the level of V_{IN} approaches V_{OUT} . Refer to the Typical Characteristics section for measured plots of efficiency versus input voltage and output load current for the given charge pump output voltage options.

Capacitor Selection

Careful selection of the four external capacitors C_{IN} , C_1 , C_2 , and C_{OUT} is important because they will affect turn-on time, output ripple, and transient performance. Optimum performance will be obtained when low equivalent series resistance (ESR) ceramic capacitors are used. In general, low ESR may be defined as less than 100m Ω . A value of 1 μ F for all four capacitors is a good starting point when choosing capacitors. If the LED current sources are only programmed for light current levels, then the capacitor size may be decreased.

Capacitor Characteristics

Ceramic composition capacitors are highly recommended over all other types of capacitors for use with the AAT3140. Ceramic capacitors offer many advantages over their tantalum and aluminum electrolytic counterparts. A ceramic capacitor typically has very low ESR, is lowest cost, has a smaller PCB footprint, and is non-polarized. Low ESR ceramic capacitors

help maximize charge pump transient response. Since ceramic capacitors are non-polarized, they are not prone to incorrect connection damage.

Equivalent Series Resistance

ESR is an important characteristic to consider when selecting a capacitor. ESR is a resistance internal to a capacitor that is caused by the leads, internal connections, size or area, material composition, and ambient temperature. Capacitor ESR is typically measured in milliohms for ceramic capacitors and can range to more than several ohms for tantalum or aluminum electrolytic capacitors.

Ceramic Capacitor Materials

Ceramic capacitors less than 0.1 μ F are typically made from NPO or COG materials. NPO and COG materials typically have tight tolerance and are stable over temperature. Large capacitor values are typically composed of X7R, X5R, Z5U, or Y5V dielectric materials. Large ceramic capacitors, typically greater than 2.2 μ F, are often available in low-cost Y5V and Z5U dielectrics, but capacitors greater than 1 μ F are typically not required for AAT3140 applications.

Capacitor area is another contributor to ESR. Capacitors that are physically large will have a lower ESR when compared to an equivalent material smaller capacitor. These larger devices can improve circuit transient response when compared to an equal value capacitor in a smaller package size.

Thermal Protection

The AAT3140 has a thermal protection circuit that will shut down the charge pump if the die temperature rises above the thermal limit, as is the case during a short circuit of the CP pin.

Charge Pump Compatibility

The four-output AAT3140 is pin-compatible with the AAT3123, AAT3132, and AAT3113 in TSOPJW-12 packages. The AAT3140 offers an improved overall efficiency, wider operating range, and the ability to drive high- V_F type LEDs at full current. The AAT3140 is well suited for battery-powered applications using single-cell lithium-ion/polymer batteries and 3-series connected dry cells (3.6V).

Ordering Information

Package	Marking ¹	Part Number (Tape and Reel) ²
TSOPJW-12	KZXY	AAT3140ITP-T1

Package Information

TSOPJW-12

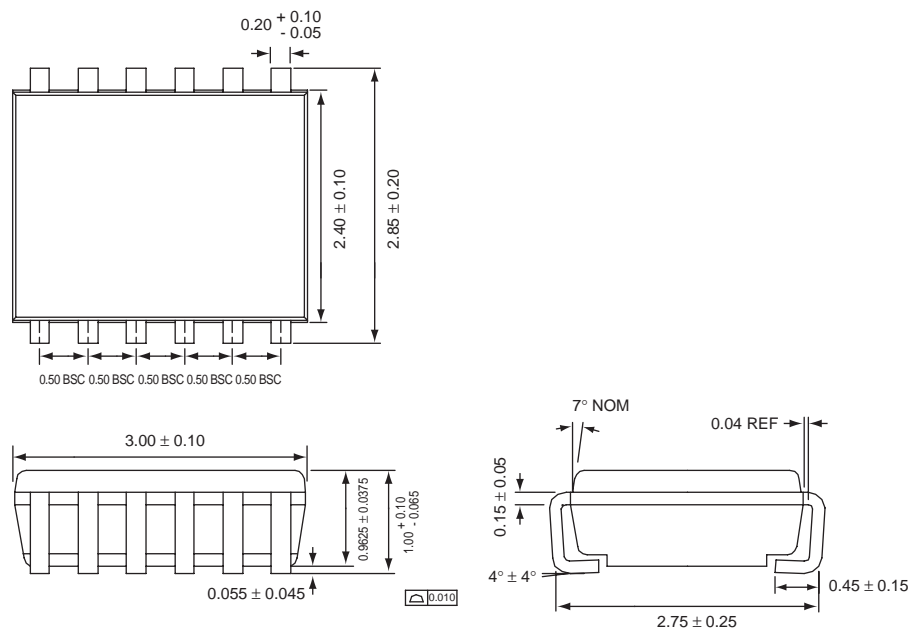

All dimensions in millimeters.

1. XYY = assembly and date code.
2. Sample stock is generally held on all part numbers listed in **BOLD**.

AnalogicTech cannot assume responsibility for use of any circuitry other than circuitry entirely embodied in an AnalogicTech product. No circuit patent licenses, copyrights, mask work rights, or other intellectual property rights are implied.

AnalogicTech reserves the right to make changes to their products or specifications or to discontinue any product or service without notice, and advise customers to obtain the latest version of relevant information to verify, before placing orders, that information being relied on is current and complete. All products are sold subject to the terms and conditions of sale supplied at the time of order acknowledgement, including those pertaining to warranty, patent infringement, and limitation of liability.

AnalogicTech warrants performance of its semiconductor products to the specifications applicable at the time of sale in accordance with AnalogicTech's standard warranty. Testing and other quality control techniques are utilized to the extent AnalogicTech deems necessary to support this warranty. Specific testing of all parameters of each device is not necessarily performed.

Advanced Analogic Technologies, Inc.
830 E. Arques Avenue, Sunnyvale, CA 94085
Phone (408) 737-4600
Fax (408) 737-4611