

SPECIFICATION

DEVICE NAME : Power MOSFET
TYPE NAME : 2SK2209-01R
SPEC. No. : **MS5F3165**

Fuji Electric Co.,Ltd.

This Specification is subject to change without notice.

	DATE	NAME	APPROVED	Fuji Electric Co.,Ltd	
DRAWN				DWG. NO.	1/11
CHECKER					

1. Scope
This specifies Fuji power MOSFET 2SK2209-01R
2. Construction N-channel enhancement mode power MOSFET
3. Application for switching
4. Outview TO-3PF Outview See to 5/11 page
5. Absolute maximum ratings at $T_c=25^\circ\text{C}$ (unless otherwise specified)

Description	Symbol	Characteristics	Unit	Remarks
Drain-source voltage	V_{DS}	500	V	
Drain-gate voltage	V_{DGR}	500	V	$R_{GS} = 20\text{K}\Omega$
Continuous Drain current	I_D	± 15	A	
Pulsed drain current	I_{Dpul}	± 60	A	
Gate-source voltage	V_{GS}	± 30	V	
Maximum power dissipation	P_D	80	W	
Operating and storage temperature range	T_{ch}	150	$^\circ\text{C}$	
	T_{stg}	-55 ~ +150	$^\circ\text{C}$	

6. Electrical characteristics at $T_c=25^\circ\text{C}$ (unless otherwise specified)

Description	Symbol	Conditions	Characteristics			Unit
			Min.	Typ.	Max.	
Drain-source breakdown voltage	$B V_{DSS}$	$I_D = 1\text{mA}$ $V_{GS} = 0\text{V}$	500			V
Gate threshold voltage	$V_{GS(th)}$	$I_D = 1\text{mA}$ $V_{DS} = V_{GS}$	2.5	3.0	3.5	V
Zero gate voltage drain current	I_{DSS}	$V_{DS} = 500\text{V}$ $V_{GS} = 0\text{V}$	$T_{ch} = 25^\circ\text{C}$	10	500	μA
	I_{DSS}		$T_{ch} = 125^\circ\text{C}$	0.2	1.0	mA
Gate-source leakage current	I_{GSS}	$V_{GS} = \pm 30\text{V}$ $V_{DS} = 0\text{V}$		10	100	nA
Drain-source on-state resistance	$R_{DS(on)}$	$I_D = 7.5\text{A}$ $V_{GS} = 10\text{V}$		0.33	0.48	Ω

Fuji Electric Co., Ltd.

DWG. NO.

2/11

Y 0257-R-003a

Dynamic ratings

Description	Symbol	Conditions	Characteristics			Unit
			Min.	Typ.	Max.	
Forward transconductance	g_{fs}	$I_D = 7.5A$ $V_{DS} = 25V$	7.0	15.0		S
Input capacitance	C_{iss}	$V_{DS} = 25V$ $V_{GS} = 0V$ $f = 1MHz$		2500	3800	pF
Output capacitance	C_{oss}			260	390	pF
Reverse transfer capacitance	C_{rss}			60	90	pF
Turn-on time	$t_{d(on)}$	$V_{CC} = 300V$ $V_{GS} = 10V$ $I_D = 15A$ $R_{GS} = 10\Omega$		30	45	ns
	t_r			70	105	ns
Turn-off time	$t_{d(off)}$			140	210	ns
	t_f			90	135	ns

Reverse diode

Description	Symbol	Conditions	Characteristics			Unit
			Min.	Typ.	Max.	
Avalanche capability	I_{AV}	$L = 100\mu H$, $T_{ch} = 25^\circ C$ * See Fig1 and 2	15			A
Diode forward on-voltage	V_{SD}	$I_F = 2 \times I_{DR}$ $V_{GS} = 0V$, $T_{ch} = 25^\circ C$		1.0	1.5	V
Reverse recovery time	t_{rr}	$I_F = I_{DR}$ $V_{GS} = 0V$ $-di_F/dt = 100A/\mu s$ $T_{ch} = 25^\circ C$		450		ns
Reverse recovery charge	Q_{rr}				3	

7. Thermal resistance

Description	Symbol	Conditions	Characteristics			Unit
			Min.	Typ.	Max.	
Thermal resistance	$R_{th_{ch-c}}$				1.56	$^\circ C/W$
	$R_{th_{ch-a}}$				30.0	$^\circ C/W$

Fuji Electric Co.,Ltd.

DWG.NO.

3/11

Fig.1 Test circuit

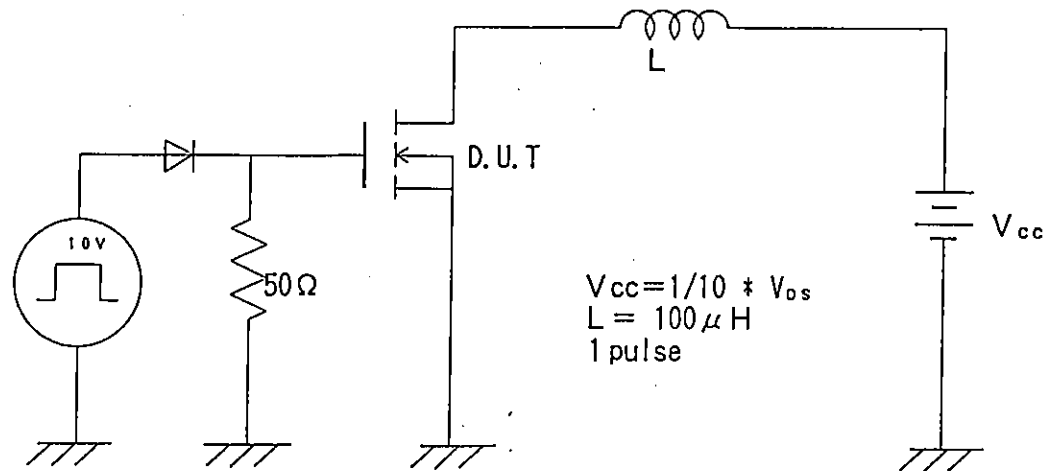
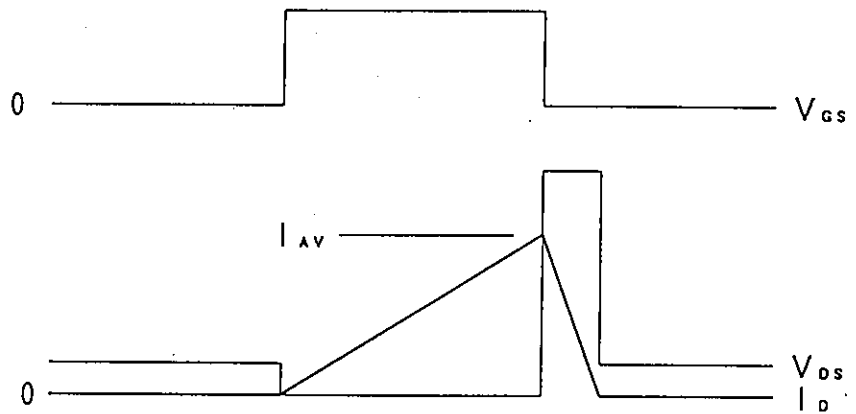
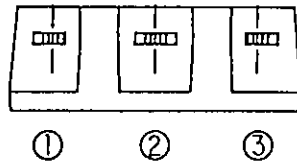
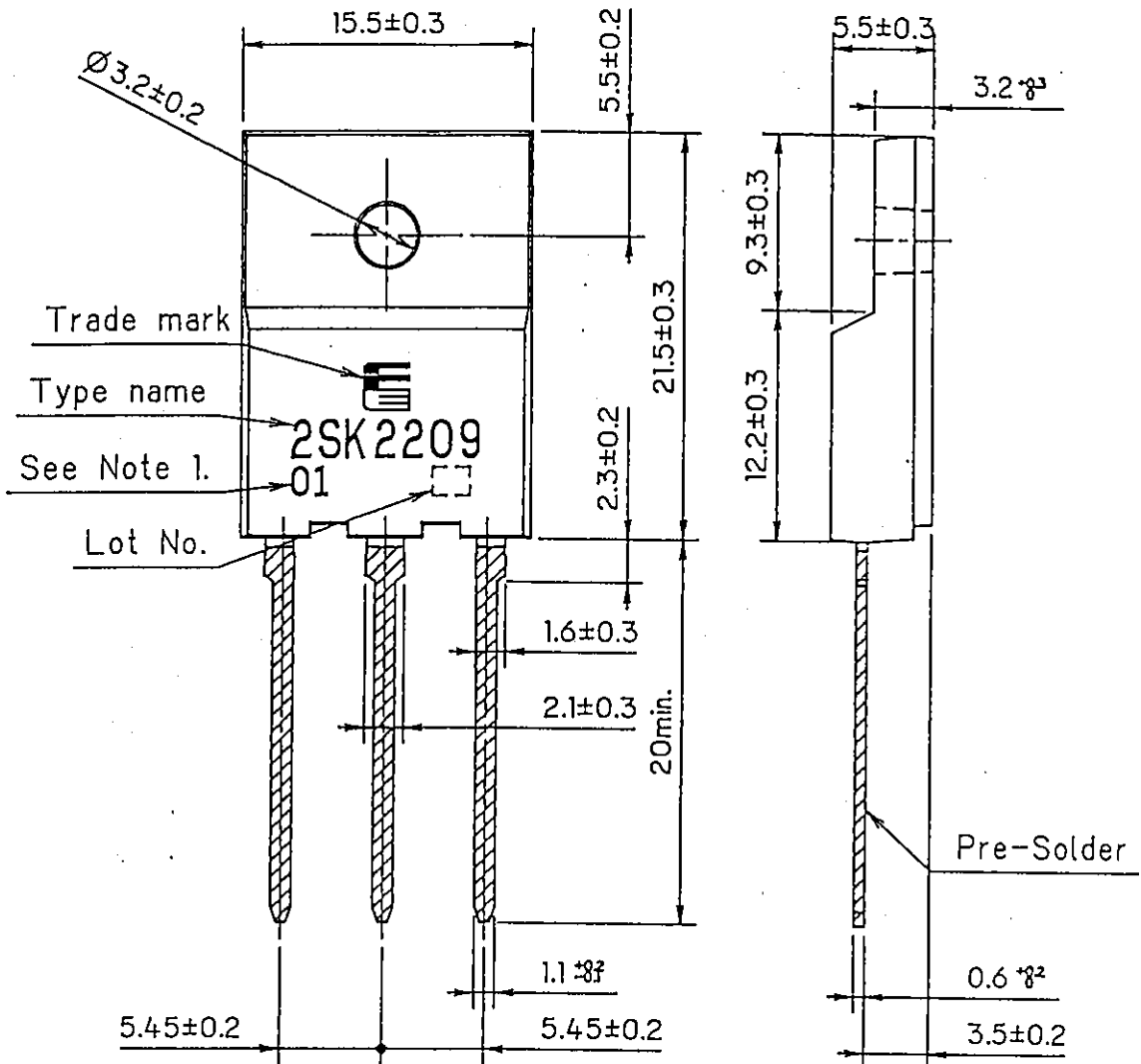

Fig.2 Operating waveforms



FUJI POWER MOSFET

TYPE : 2SK2209-01R



CONNECTION

- ① GATE
- ② DRAIN
- ③ SOURCE

Note 1. Guaranteed mark of avalanche ruggedness.

DIMENSIONS ARE IN MILLIMETERS.

Fuji Electric Co., Ltd.

DWG. NO.

5/11

Y 0257-R-003a

Power Dissipation
 $PD=f(TC)$

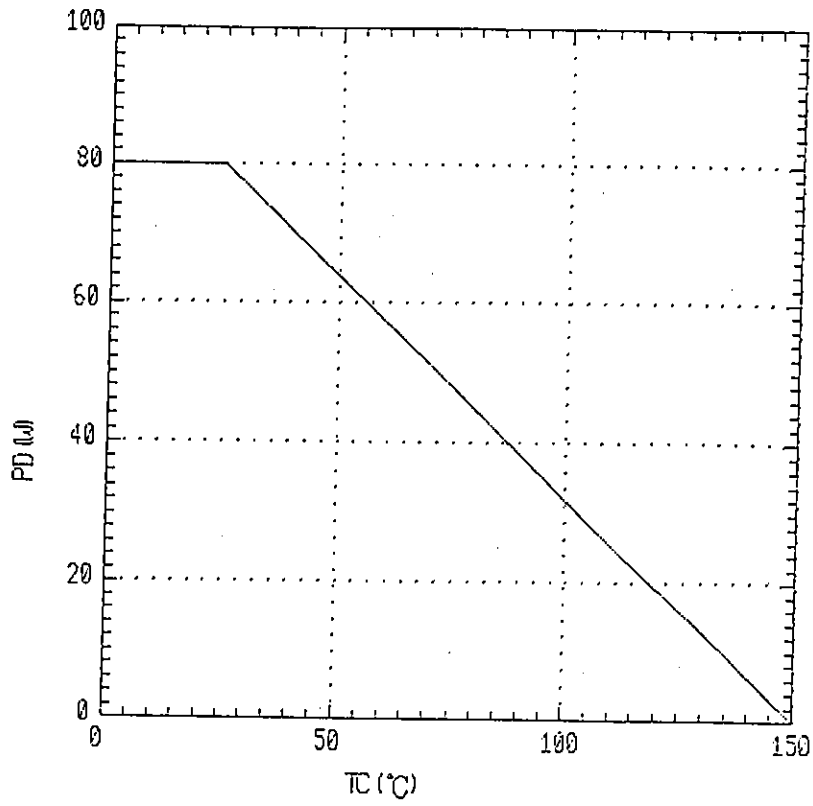

Safe operating area
 $ID=f(VDS): D=0.01, Tc=25^{\circ}C$

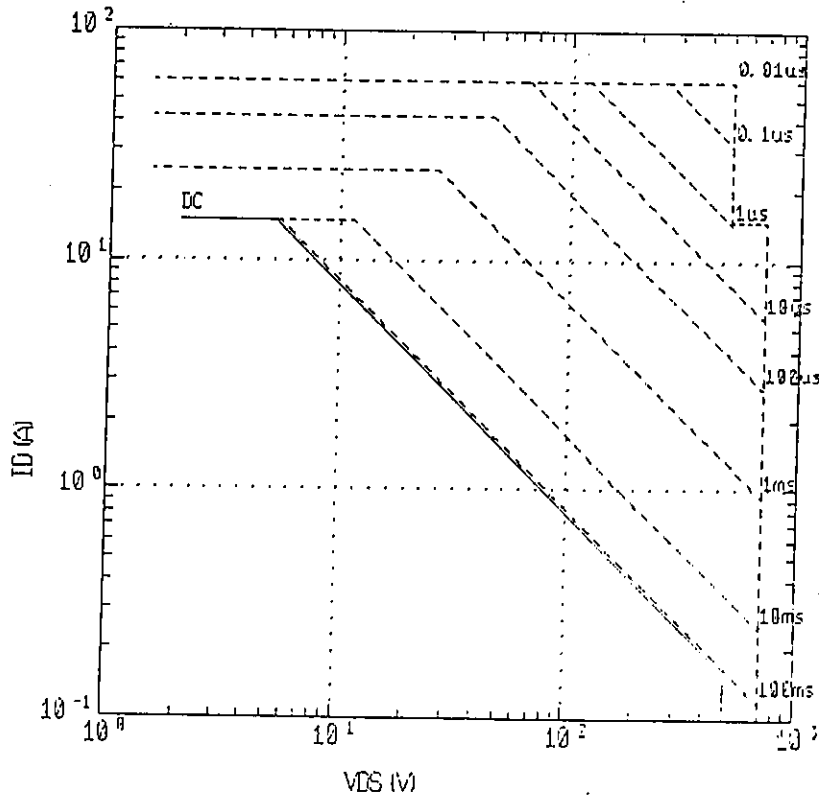

Fuji Electric Co., Ltd.

DWG. NO.

6/11

Typical output characteristics
 $I_D = f(V_{DS})$: $80 \mu s$ pulse test, $T_{ch} = 25^\circ C$

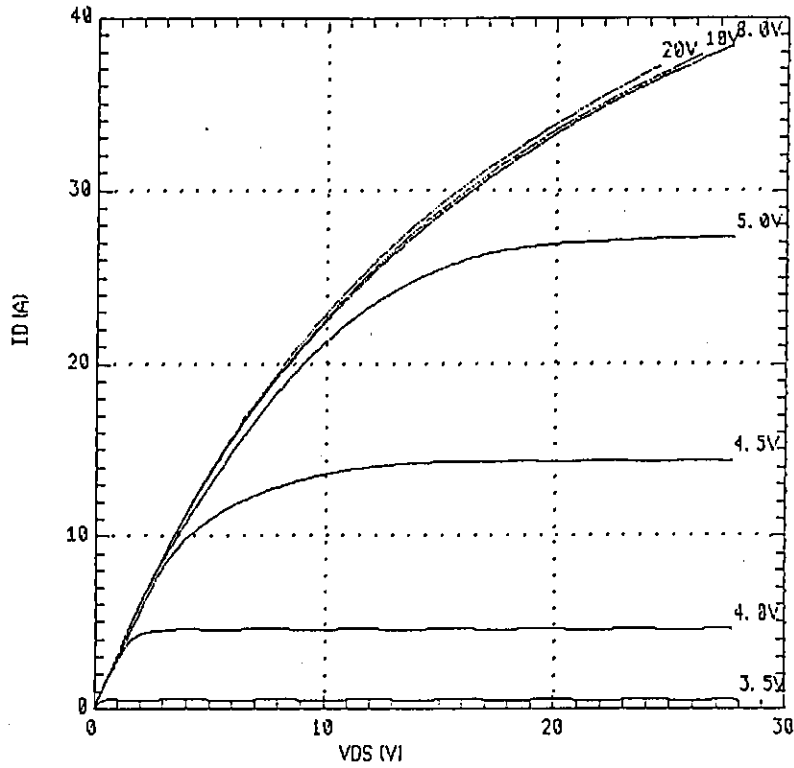

Typical Transfer Characteristic
 $I_D = f(V_{GS})$: $80 \mu s$ pulse test, $V_{DS} = 25V$

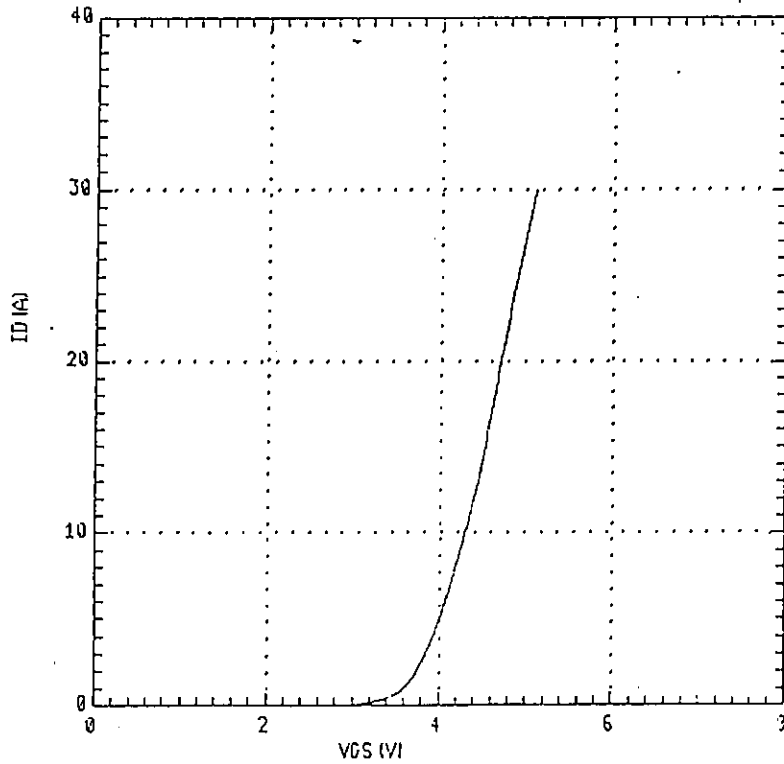

Typical Transconductance
 $g_{fs}=f(I_D)$: $80\mu s$ pulse test, $V_{DS}=25V$, $T_{ch}=25^\circ C$

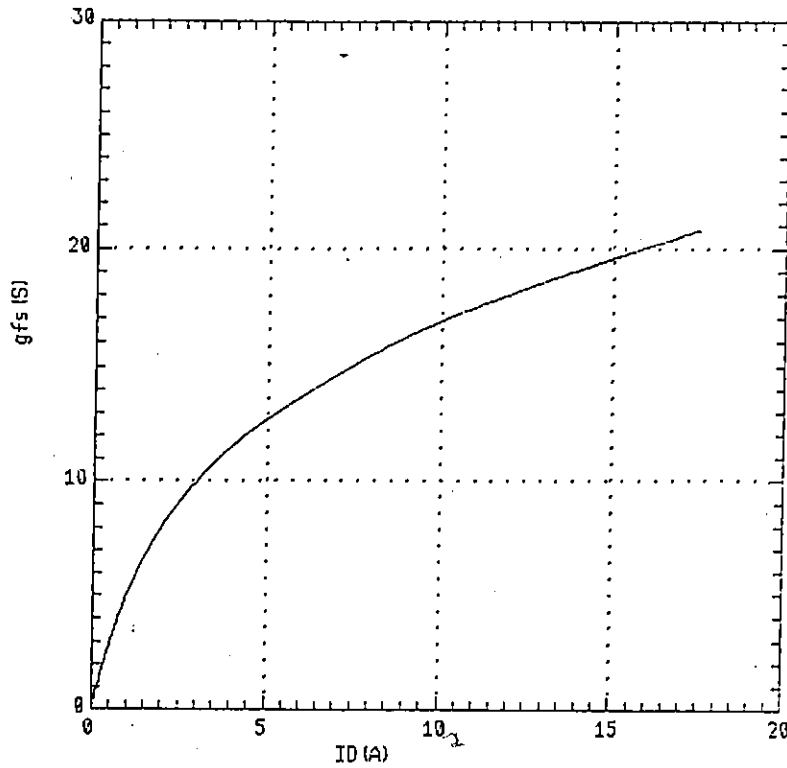

Typical Drain-source on-state resistance
 $R_{DS(on)}=f(I_D)$: $80\mu s$ pulse test, $T_{ch}=25^\circ C$

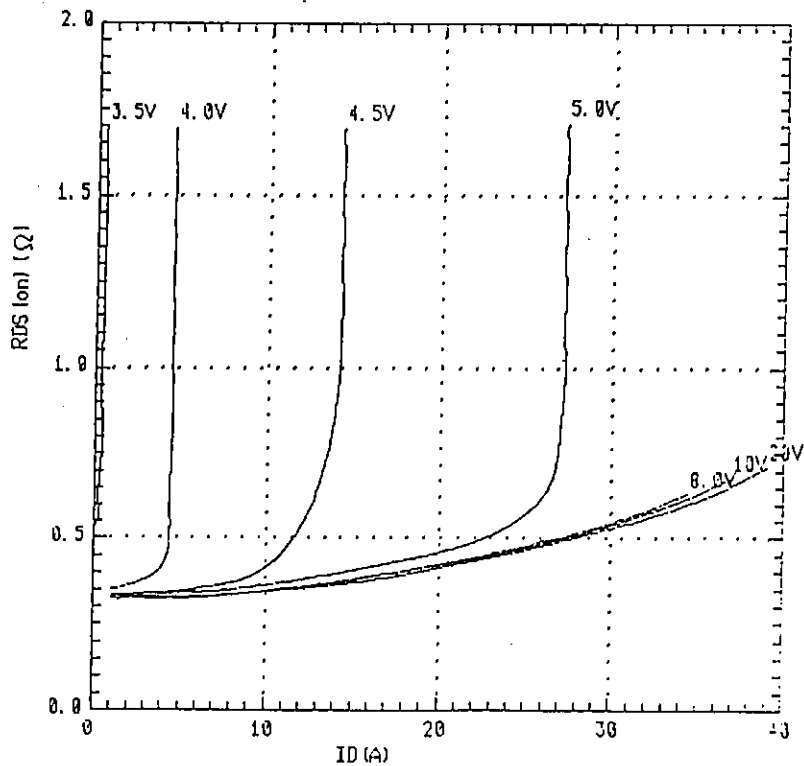

Drain-source on-state resistance
 $R_{DS(on)} = f(T_{ch}) : I_D = 7.5A, V_{GS} = 10V$

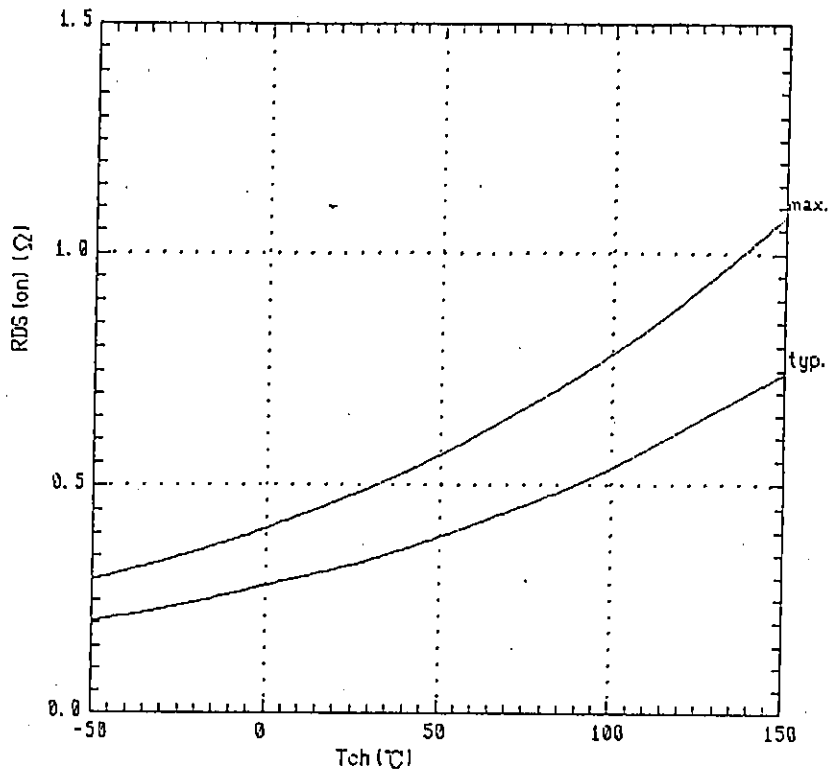

Gate threshold voltage
 $V_{GS(th)} = f(T_{ch}) : V_{DS} = V_{GS}, I_D = 1mA$

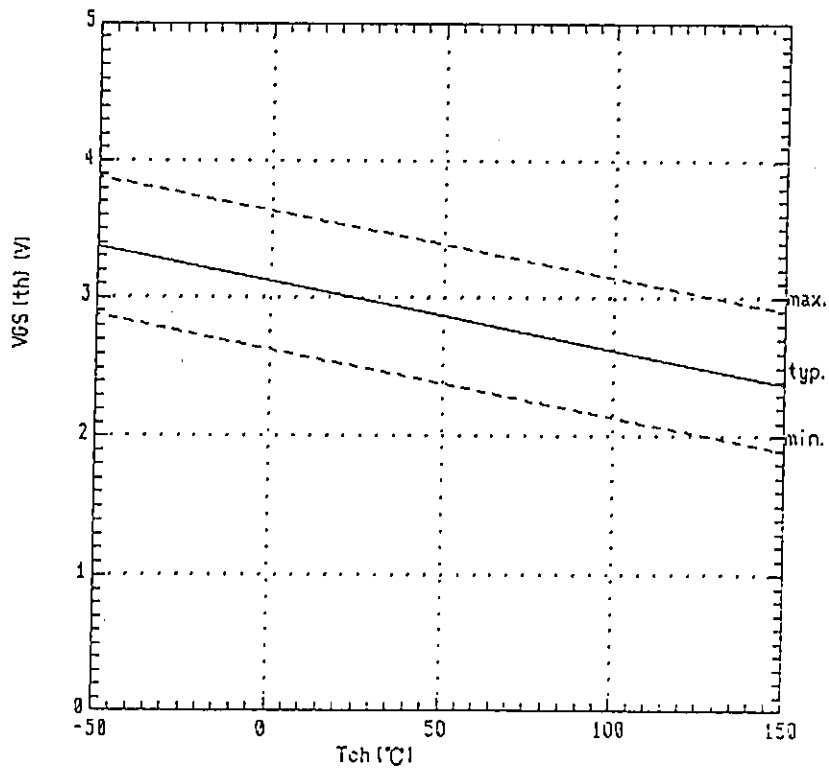

Typical capacitances
 $C=f(V_{DS}): V_{GS}=0V, f=1MHz$

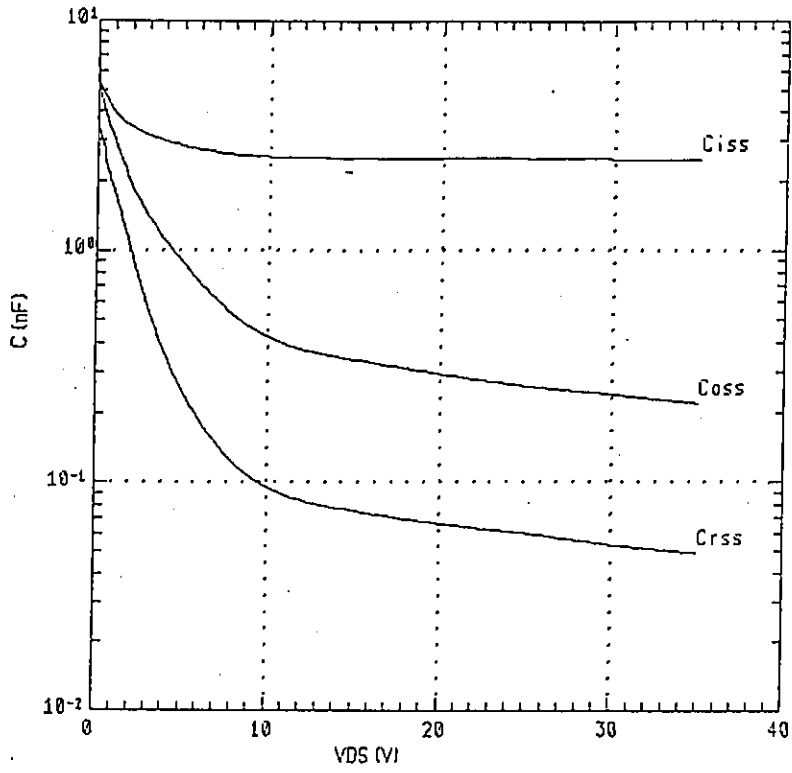

Forward characteristic of reverse diode
 $I_F=f(V_{SD}): 80\mu s$ pulse test

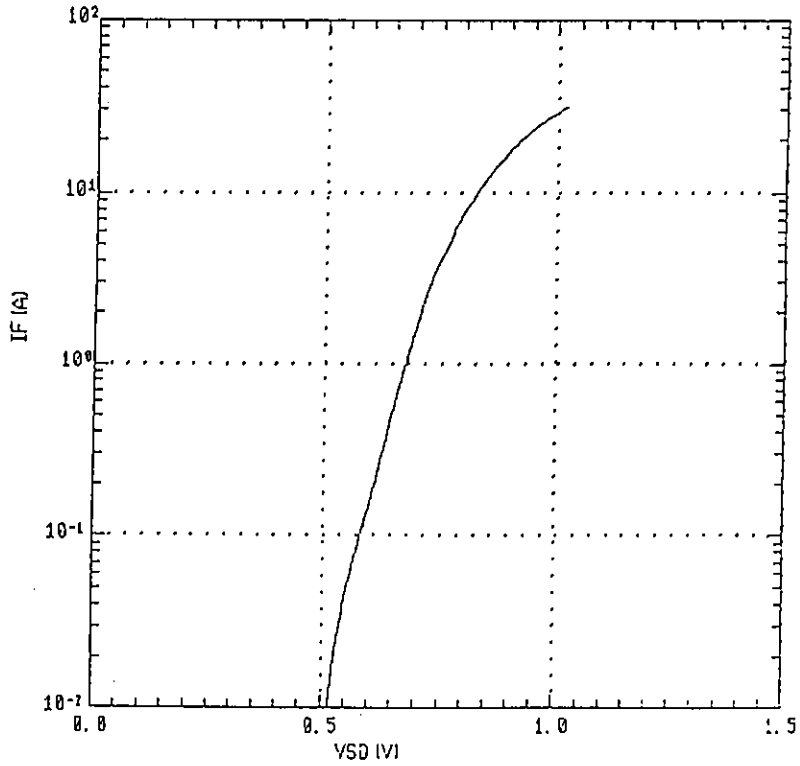

Typical gate charge characteristics
 $V_{GS} = f(Q_g) : I_D = 15A$

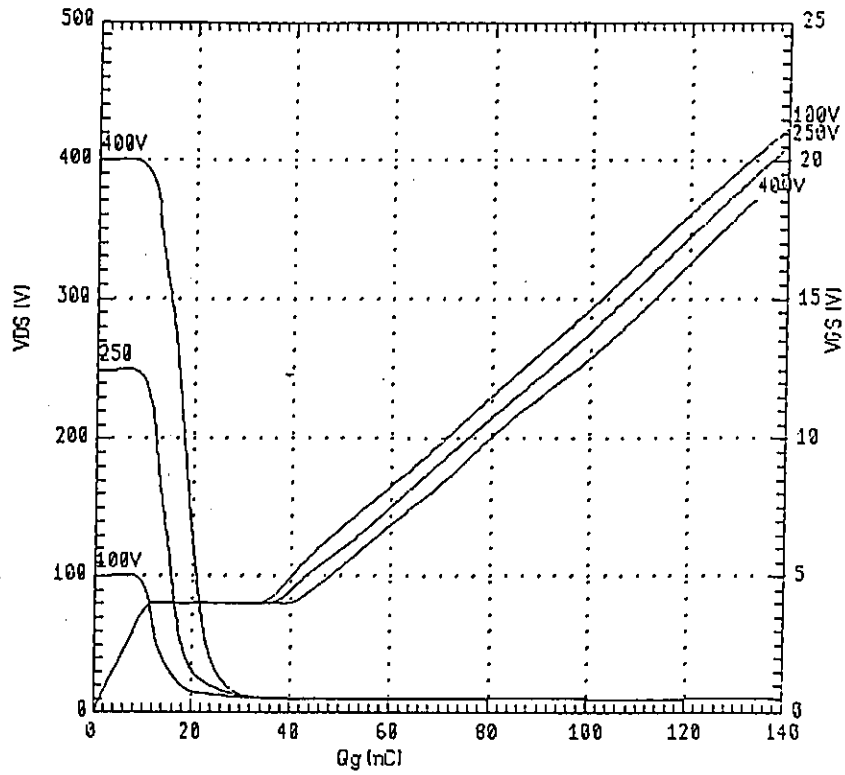

Transient thermal
 impedance $Z_{thch-c} = f(t)$ parameter: $D = t/T$

