



ECL/PECL Dual Differential 2:1 Multiplexer

MAX9384

General Description

The MAX9384 fully differential dual 2:1 multiplexer (mux) features extremely low propagation delay (560ps max) and output-to-output skew (40ps max). The device is ideal for clock and data multiplexing applications. The two 2:1 muxes are controlled individually or simultaneously through mux select inputs COM_SEL, SEL0, and SEL1. The mux select inputs are compatible with ECL/PECL logic, and are referenced to on-chip outputs V_{BB0} and V_{BB1} , nominally $V_{CC} - 1.33V$.

The differential inputs D , \bar{D} can be configured to accept a single-ended signal when the unused complementary input is connected to the on-chip supply output V_{BB} as a reference voltage. All the differential inputs have bias and clamp circuits that force the outputs to a low default when the inputs are left open or at V_{EE} . The single-ended mux select inputs have pulldowns to V_{EE} , providing low default inputs when the select inputs are left open.

The device operates with a wide supply range ($V_{CC} - V_{EE}$) of +3.0V to +5.5V for PECL or -3.0V to -5.5V for ECL, and is pin compatible with the MC100LVEL56 and MC100EL56. The MAX9384 is offered in a 20-pin wide SO package, and is specified for operation from -40°C to +85°C.

Applications

High-Speed Telecom, Datacom Applications
 Central-Office Backplane Clock Distribution
 Access Multiplexers (DSLAM/DLC)

Functional Diagram appears at end of data sheet.

Features

- ◆ 40ps-p Deterministic Jitter
- ◆ 440ps Differential Propagation Delay
- ◆ 12ps Output-to-Output Skew
- ◆ Individual and Common Select
- ◆ +3.0V to +5.5V Supplies for Differential LVPECL/PECL
- ◆ -3.0V to -5.5V Supplies for Differential LVECL/ECL
- ◆ Outputs Low for Inputs Open or at V_{EE}
- ◆ >2kV ESD Protection (Human Body Model)
- ◆ Pin Compatible with MC100LVEL56 and MC100EL56

Ordering Information

PART	TEMP RANGE	PIN-PACKAGE
MAX9384EWP	-40°C to +85°C	20 Wide SO

Pin Configuration

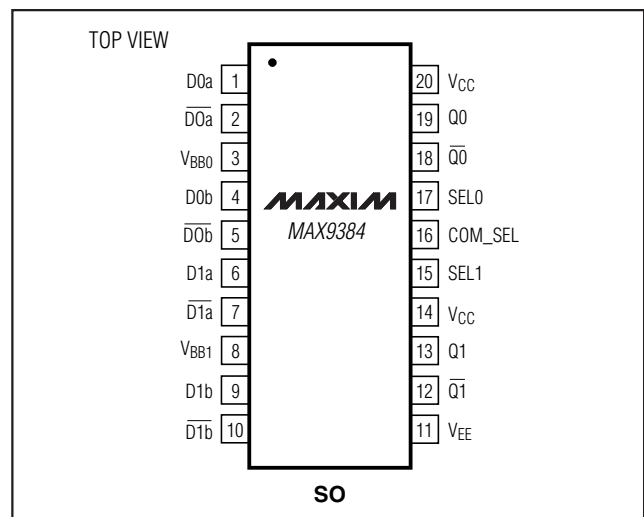

ECL/PECL Dual Differential 2:1 Multiplexer

ABSOLUTE MAXIMUM RATINGS

V _{CC} - V _{EE}	-0.3V to 6.0V	Junction-to-Case Thermal Resistance	
Inputs (\overline{D}_- , \overline{D}_- , SEL ₋ , COM_SEL) to V _{EE}	-0.3V to (V _{CC} + 0.3V)	20-Lead Wide SO	+20°C/W
D ₋ to \overline{D}_-	±3.0V	Continuous Power Dissipation (T _A = +70°C)	
Continuous Output Current	50mA	20-Lead Wide SO	
Surge Output Current.....	100mA	(derate 10mW/°C above +70°C).....	800mW
V _{BB} Sink/Source Current	±0.65mA	Operating Temperature Range	-40°C to +85°C
Junction-to-Ambient Thermal Resistance in Still Air		Junction Temperature	+150°C
20-Lead Wide SO	+100°C/W	Storage Temperature Range	-65°C to +150°C
Junction-to-Ambient Thermal Resistance with		ESD Protection	
500LFPM Airflow		Human Body Model	
20-Lead Wide SO	+58°C/W	(D ₋ , \overline{D}_- , Q ₋ , \overline{Q}_- , SEL ₋ , COM_SEL)	≥ 2kV
		Soldering Temperature (10s).....	+300°C

Stresses beyond those listed under "Absolute Maximum Ratings" may cause permanent damage to the device. These are stress ratings only, and functional operation of the device at these or any other conditions beyond those indicated in the operational sections of the specifications is not implied. Exposure to absolute maximum rating conditions for extended periods may affect device reliability.

DC ELECTRICAL CHARACTERISTICS

(V_{CC} - V_{EE} = 3.0V to 5.5V, outputs loaded with 50Ω ±1% to V_{CC} - 2V. Typical values are at V_{CC} - V_{EE} = 3.3V, V_{IHD} = V_{CC} - 1V, V_{I LD} = V_{CC} - 1.5V, unless otherwise noted.) (Notes 1, 2, 3)

PARAMETER	SYMBOL	CONDITIONS	-40°C			+25°C			+85°C			UNITS
			MIN	TYP	MAX	MIN	TYP	MAX	MIN	TYP	MAX	
SINGLE-ENDED INPUT SEL₋, COM_SEL												
Input High Voltage	V _{IH}	Internally referenced to V _{BB} , Figure 1	V _{CC} - 1.165	V _{CC}	V _{CC} - 1.165	V _{CC}	V _{CC} - 1.165	V _{CC}	V _{CC} - 1.165	V _{CC}	V	
Input Low Voltage	V _{IL}	Internally referenced to V _{BB} , Figure 1	V _{CC} - 1.810	V _{CC} - 1.475	V _{CC} - 1.810	V _{CC} - 1.475	V _{CC} - 1.810	V _{CC} - 1.475	V _{CC} - 1.810	V _{CC} - 1.475	V	
Input Current	I _{IN}	V _{IH} , V _{IL}	-10	+50	-10	+50	-10	+50	-10	+50	μA	
DIFFERENTIAL INPUT (D₋, \overline{D}_-)												
Single-Ended Input High Voltage	V _{IH}	V _{BB} connected to the unused input, Figure 1	V _{CC} - 1.165	V _{CC}	V _{CC} - 1.165	V _{CC}	V _{CC} - 1.165	V _{CC}	V _{CC} - 1.165	V _{CC}	V	
Single-Ended Input Low Voltage	V _{IL}	V _{BB} connected to the unused input, Figure 1	V _{CC} - 1.810	V _{CC} - 1.475	V _{CC} - 1.810	V _{CC} - 1.475	V _{CC} - 1.810	V _{CC} - 1.475	V _{CC} - 1.810	V _{CC} - 1.475	V	
High Voltage of Differential Input	V _{IHD}	Figure 1	V _{EE} + 1.3	V _{CC}	V _{EE} + 1.2	V _{CC}	V _{EE} + 1.2	V _{CC}	V _{EE} + 1.2	V _{CC}	V	
Low Voltage of Differential Input	V _{I LD}	Figure 1	V _{EE}	V _{CC} - 0.095	V _{EE}	V _{CC} - 0.095	V _{EE}	V _{CC} - 0.095	V _{EE}	V _{CC} - 0.095	V	
Differential Input Voltage	V _{IHD} - V _{I LD}	Figure 1	0.095	3.0	0.095	3.0	0.095	3.0	0.095	3.0	V	
Input Current	I _{IN}	V _{IH} , V _{IL} , V _{IHD} , V _{I LD}	-100	+100	-100	+100	-100	+100	-100	+100	μA	

ECL/PECL Dual Differential 2:1 Multiplexer

MAX9384

DC ELECTRICAL CHARACTERISTICS (continued)

($V_{CC} - V_{EE} = 3.0V$ to $5.5V$, outputs loaded with $50\Omega \pm 1\%$ to $V_{CC} - 2V$. Typical values are at $V_{CC} - V_{EE} = 3.3V$, $V_{IHD} = V_{CC} - 1V$, $V_{ILD} = V_{CC} - 1.5V$, unless otherwise noted.) (Notes 1, 2, 3)

PARAMETER	SYMBOL	CONDITIONS	-40°C			+25°C			+85°C			UNITS
			MIN	TYP	MAX	MIN	TYP	MAX	MIN	TYP	MAX	
OUTPUT (Q₊, Q₋)												
Single-Ended Output High Voltage	V_{OH}	Figure 2	$V_{CC} - 1.085$	$V_{CC} - 0.998$	$V_{CC} - 0.880$	$V_{CC} - 1.025$	$V_{CC} - 0.947$	$V_{CC} - 0.880$	$V_{CC} - 1.025$	$V_{CC} - 0.929$	$V_{CC} - 0.880$	V
Single-Ended Output Low Voltage	V_{OL}	Figure 2	$V_{CC} - 1.830$	$V_{CC} - 1.707$	$V_{CC} - 1.555$	$V_{CC} - 1.810$	$V_{CC} - 1.685$	$V_{CC} - 1.620$	$V_{CC} - 1.810$	$V_{CC} - 1.690$	$V_{CC} - 1.620$	V
Differential Output Voltage	$V_{OH} - V_{OL}$	Figure 2	600			640			660			mV
REFERENCE OUTPUT (V_{BB})												
Reference Voltage Output	V_{BB}	$I_{BB} = \pm 0.5mA$ (Note 4)	$V_{CC} - 1.38$	$V_{CC} - 1.322$	$V_{CC} - 1.26$	$V_{CC} - 1.38$	$V_{CC} - 1.330$	$V_{CC} - 1.26$	$V_{CC} - 1.38$	$V_{CC} - 1.335$	$V_{CC} - 1.26$	V
SUPPLY												
Supply Current	I_{EE}	(Note 5)	15 24			17 24			19 24			mA

ECL/PECL Dual Differential 2:1 Multiplexer

AC ELECTRICAL CHARACTERISTICS

($V_{CC} - V_{EE} = 3.0V$ to $5.5V$, outputs loaded with $50\Omega \pm 1\%$ to $V_{CC} - 2V$, $V_{IH} - V_{ILD} = 0.15V$ to $1V$, $f_{IN} \leq 500MHz$, input duty cycle = 50%, input transition time = 125ps (20% to 80%). Typical values are at $V_{CC} - V_{EE} = 3.3V$, $V_{IH} = V_{CC} - 1V$, $V_{ILD} = V_{CC} - 1.5V$, unless otherwise noted.) (Note 6)

PARAMETER	SYMBOL	CONDITIONS	-40°C			+25°C			+85°C			UNITS
			MIN	TYP	MAX	MIN	TYP	MAX	MIN	TYP	MAX	
Differential Input-to-Output Delay	t_{PLHD} , t_{PHLD}	Figure 2	340		540	350		550	360		560	ps
Single-Ended Input-to-Output Delay	t_{PLH1} , t_{PHL1}	Figure 3 (Note 7)	290		540	310		560	330		580	ps
SEL_ and COM_SEL to Output Delay	t_{PLH2} , t_{PHL2}	Figure 4 (Note 7)	310		730	320		740	330		750	ps
Output-to-Output Skew	t_{SKOO}	(Note 8)		12	40		12	40		12	40	ps
Added Random Jitter	t_{RJ}	$f_{IN} = 500MHz$ (Note 9)		0.3	0.8		0.4	0.8		0.5	0.8	ps(RMS)
Added Deterministic Jitter	t_{DJ}	1.0Gbps $2^{23} - 1$ PRBS pattern (Note 9)		40	70		40	70		40	70	ps(P-P)
Switching Frequency	f_{MAX}	$V_{OH} - V_{OL} \geq 300mV$, Figure 2	1.5			1.5			1.5			GHz
Output Rise and Fall Time (20% to 80%)	t_R , t_F	Figure 2	200	310	440	200	310	440	200	310	440	ps

Note 1: Measurements are made with the device in thermal equilibrium.

Note 2: Current into a pin is defined as positive. Current out of a pin is defined as negative.

Note 3: DC parameters production tested at $T_A = +25^\circ C$ and guaranteed by design over the full operating temperature range.

Note 4: Use V_{BB} only for inputs that are on the same device as the V_{BB} reference.

Note 5: All pins open except V_{CC} and V_{EE} .

Note 6: Guaranteed by design and characterization. Limits are set at ± 6 sigma.

Note 7: Test conditions are $V_{IH} = V_{CC} - 1.11V$ and $V_{IL} = V_{CC} - 1.53V$.

Note 8: Measured between outputs of the same part at the signal crossing points for a same-edge transition. Differential input signal.

Note 9: Device jitter added to the input signal. Differential input signal.

ECL/PECL Dual Differential 2:1 Multiplexer

Typical Operating Characteristics

($V_{CC} - V_{EE} = 3.3V$, $V_{IH} = V_{CC} - 1V$, $V_{IL} = V_{CC} - 1.5V$, $COM_SEL = low$, $SEL_ = low$, outputs loaded with $50\Omega \pm 1\%$ to $V_{CC} - 2V$, $f_{IN} = 500MHz$, input duty cycle = 50%, input transition time = 125ps (20% to 80%), unless otherwise noted.)

DIFFERENTIAL OUTPUT EYE PATTERN AT 1Gbps, PRBS 2²³ - 1, NRZ DATA PATTERN

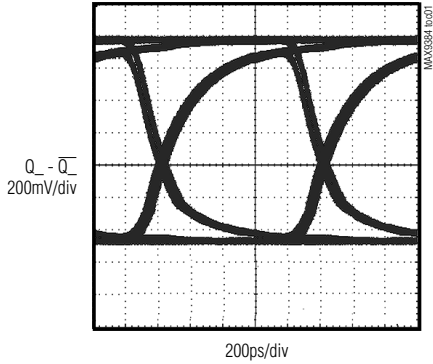

DIFFERENTIAL OUTPUT EYE PATTERN AT 500Mbps, PRBS 2²³ - 1, NRZ DATA PATTERN

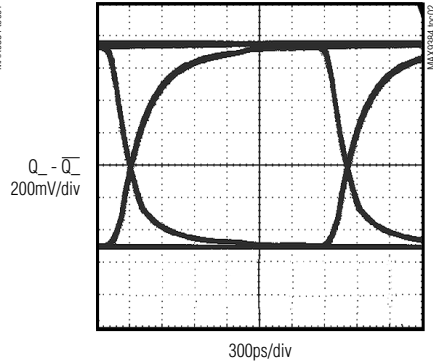

SUPPLY CURRENT (I_{EE}) vs. TEMPERATURE

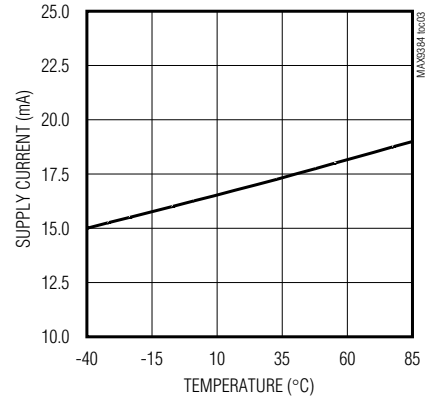

OUTPUT AMPLITUDE ($V_{OH} - V_{OL}$) vs. FREQUENCY

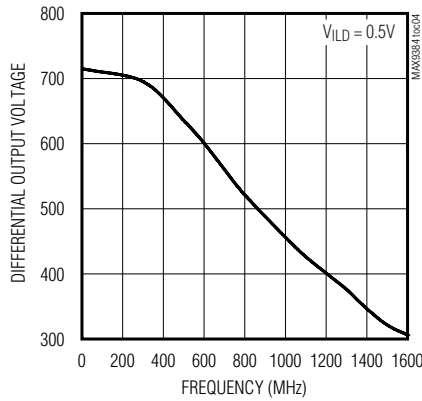

TRANSITION TIME vs. TEMPERATURE

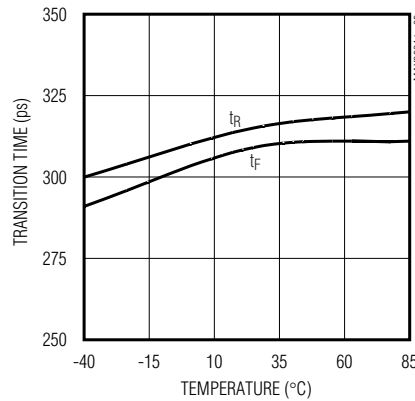

DIFFERENTIAL PROPAGATION DELAY vs. TEMPERATURE

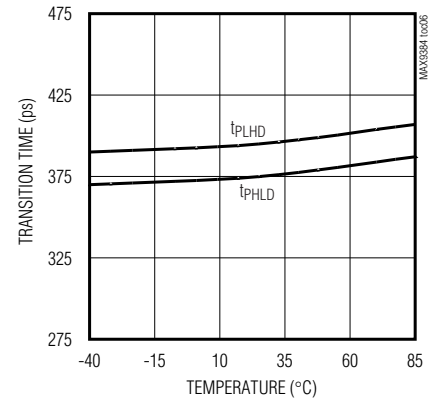

ECL/PECL Dual Differential 2:1 Multiplexer

Pin Description

PIN	NAME	FUNCTION
1	D0a	Noninverting Differential Input a for MUX 0. Internal 120k Ω pulldown to V _{EE} .
2	$\overline{D0a}$	Inverting Differential Input a for MUX 0. Internal 120k Ω pulldown to V _{EE} and 120k Ω pullup to V _{CC} .
3	V _{BB0}	Reference Output Voltage. Connect to the inverting or noninverting clock input to provide a reference for single-ended operation. When used, bypass V _{BB0} to V _{CC} with a 0.01 μ F ceramic capacitor. Otherwise leave open. V _{BB0} is internally connected to V _{BB1} .
4	D0b	Noninverting Differential Input b for MUX 0. Internal 120k Ω pulldown to V _{EE} .
5	$\overline{D0b}$	Inverting Differential Input b for MUX 0. Internal 120k Ω pulldown to V _{EE} and 120k Ω pullup to V _{CC} .
6	D1a	Noninverting Differential Input a for MUX 1. Internal 120k Ω pulldown to V _{EE} .
7	$\overline{D1a}$	Inverting Differential Input a for MUX 1. Internal 120k Ω pulldown to V _{EE} and 120k Ω pullup to V _{CC} .
8	V _{BB1}	Reference Output Voltage. Connect to the inverting or noninverting clock input to provide a reference for single-ended operation. When used, bypass V _{BB1} to V _{CC} with a 0.01 μ F ceramic capacitor. Otherwise leave open. V _{BB1} is internally connected to V _{BB0} .
9	D1b	Noninverting Differential Input b for MUX 1. Internal 120k Ω pulldown to V _{EE} .
10	$\overline{D1b}$	Inverting Differential Input b for MUX 1. Internal 120k Ω pulldown to V _{EE} and 120k Ω pullup to V _{CC} .
11	V _{EE}	Negative Supply Voltage
12	$\overline{Q1}$	Inverting Output for MUX 1. Typically terminate with 50 Ω resistor to V _{CC} - 2V.
13	Q1	Noninverting Output for MUX 1. Typically terminate with 50 Ω resistor to V _{CC} - 2V.
14, 20	V _{CC}	Positive Supply Voltage. Bypass each V _{CC} to V _{EE} with 0.1 μ F and 0.01 μ F ceramic capacitors. Place the capacitors as close to the device as possible with the smaller value capacitor closest to the device.
15	SEL1	Select Logic Input for MUX 1. Internal 210k Ω pulldown to V _{EE} .
16	COM_SEL	Common Select Logic Input. Internal 210k Ω pulldown to V _{EE} .
17	SEL0	Select Logic Input for MUX 0. Internal 210k Ω pulldown to V _{EE} .
18	$\overline{Q0}$	Inverting Output for MUX 0. Typically terminate with 50 Ω resistor to V _{CC} - 2V.
19	Q0	Noninverting Output for MUX 0. Typically terminate with 50 Ω resistor to V _{CC} - 2V.

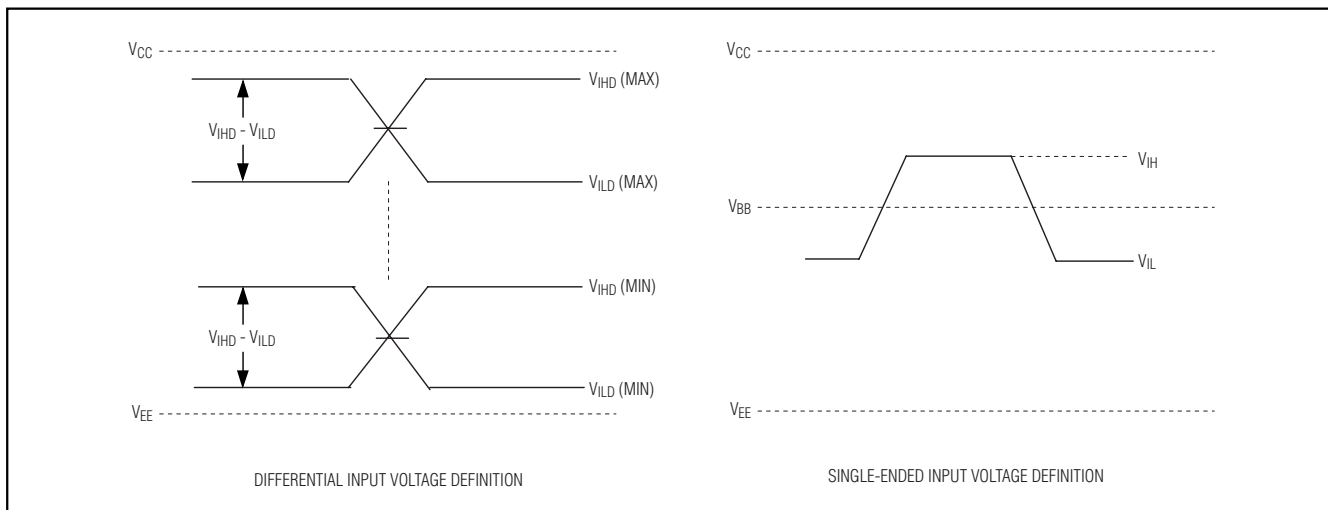

Figure 1. Input Definitions

ECL/PECL Dual Differential 2:1 Multiplexer

MAX9384

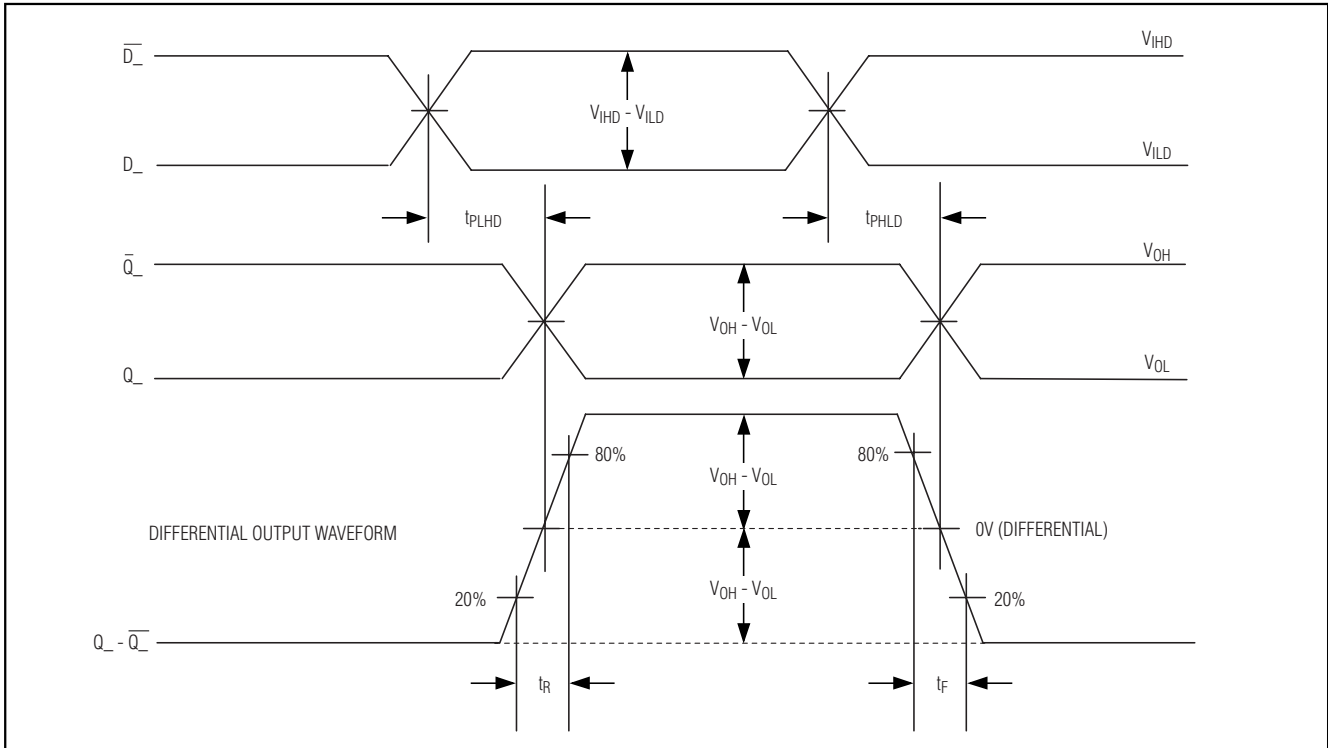

Figure 2. Differential Input-to-Output Propagation Delay Timing Diagram

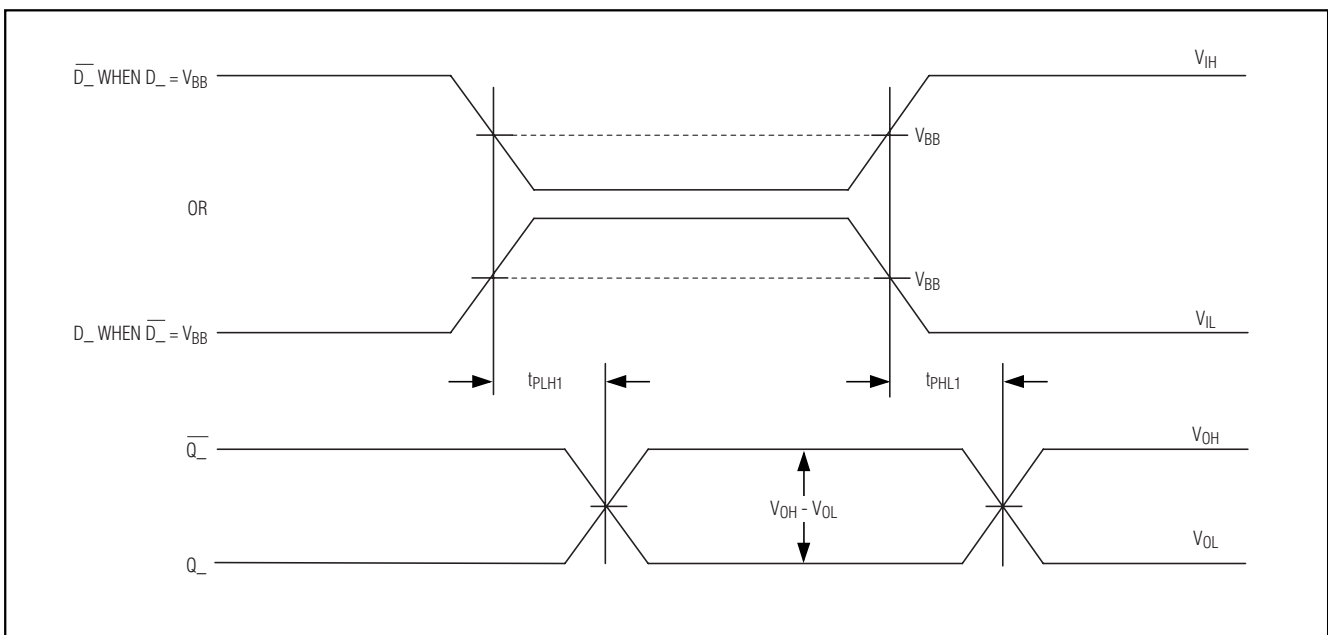

Figure 3. Single-Ended Input-to-Output Propagation Delay Timing Delay

ECL/PECL Dual Differential 2:1 Multiplexer

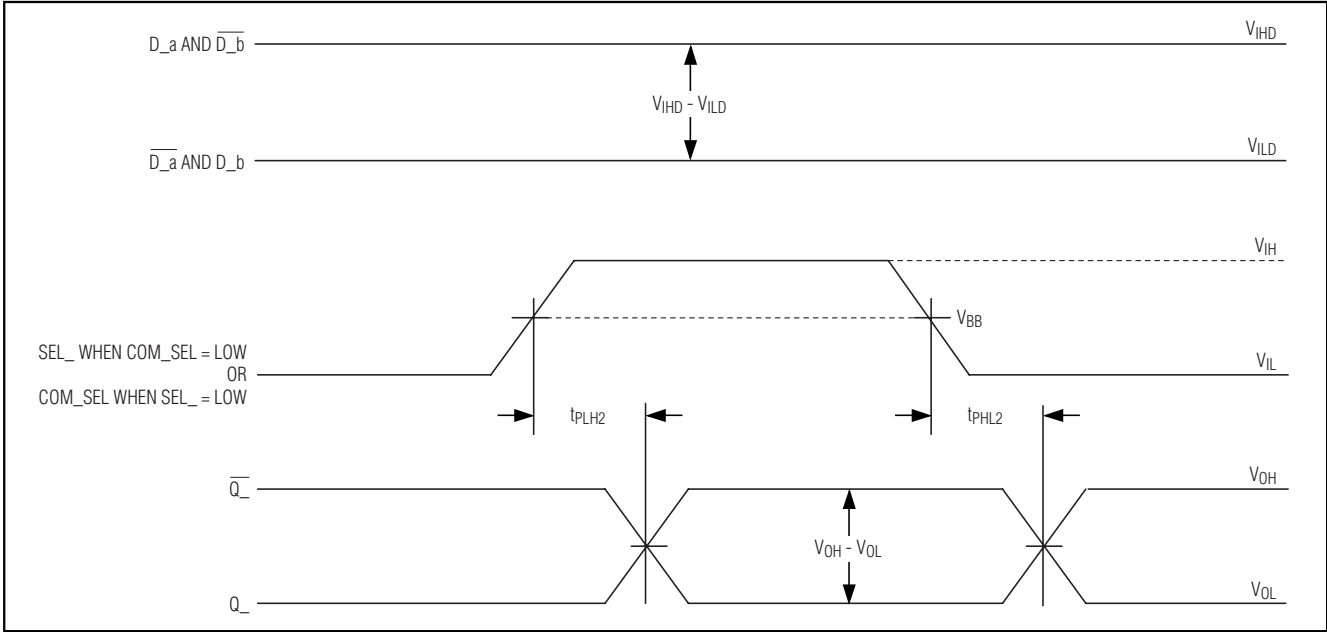

Figure 4. Select Inputs (COM_SEL, SEL_) to Output (Q_, Q_) Delay Timing Diagram

Detailed Description

The MAX9384 dual differential 2:1 multiplexer features extremely low propagation delay (560ps max) and output-to-output skew (40ps max). These features make the device ideal for clock and data multiplexing applications.

The two differential muxes are controlled individually or simultaneously through select control inputs, SEL0, SEL1, and COM_SEL (see Table 1). The select control inputs are referenced to V_{BB} (nominally V_{CC} - 1.33V) and are internally pulled down to V_{EE} through 210kΩ resistors. By default, the select inputs are low when left open.

The differential inputs D₋, D₋ can be configured to accept a single-ended signal when the unused complementary input is connected to the on-chip reference voltage V_{BB}. The reference output voltage, pins V_{BB0} and V_{BB1}, provides the input reference voltage for single-ended operation for each mux. A single-ended input of at least V_{BB} ±95mV or a differential input of at least 95mV switches the outputs to the V_{OH} and V_{OL} levels

Table 1. Input Select Truth Table

CONTROL INPUT		DATA INPUT
COM_SEL	SEL_	D_-, D_-
L or open	L or open	b*
	H	a
H	X	a

*Default input when COM_SEL and SEL_ are left open.

specified in the DC Electrical Characteristics. The maximum magnitude of the differential input from D₋ to D₋ is ±3.0V. Specifications for the high and low voltages of a differential input (V_{IHD} and V_{ILD}) and the differential input voltage (V_{IHD} - V_{ILD}) apply simultaneously.

The device operates over a wide supply range (V_{CC} - V_{EE}) of +3.0V to +5.5V for PECL or -3.0V to -5.5V for ECL, and is pin compatible with the MC100LVEL56 and MC100EL56.

Single-Ended Operation

A single-ended input can be driven to V_{CC} and V_{EE} or by a single-ended LVPECL/LVECL signal. D₋, D₋ are differential inputs but can be configured to accept single-ended inputs. This is accomplished by connecting the on-chip reference voltage, V_{BB}, to an unused complementary input as a reference. For example, the differential D0a, D0a input is converted to a noninverting, single-ended input by connecting V_{BB0} to D0a and connecting the single-ended input to D0a. Similarly, an inverting input is obtained by connecting V_{BB0} to D0a and connecting the single-ended input to D0a.

When using the V_{BB} reference output, bypass it with a 0.01μF ceramic capacitor to V_{CC}. If not used, leave it open. The V_{BB} reference can source or sink 0.5mA, which is sufficient to drive two inputs.

ECL/PECL Dual Differential 2:1 Multiplexer

Applications Information

Output Termination

Terminate the outputs through 50Ω to $V_{CC} - 2V$ or use equivalent Thevenin terminations. Terminate each Q_{-} and \overline{Q}_{-} output with identical termination on each for minimal distortion. When a single-ended signal is taken from the differential output, terminate both Q_{-} and \overline{Q}_{-} . Ensure that output currents do not exceed the current limits as specified in the *Absolute Maximum Ratings* table. Under all operating conditions, the device's total thermal limits should be observed.

Supply Bypassing

Bypass each V_{CC} to V_{EE} with high-frequency surface-mount ceramic $0.1\mu F$ and $0.01\mu F$ capacitors. Place the capacitors as close to the device as possible, with the $0.01\mu F$ capacitor closest to the device pins.

Use multiple vias when connecting the bypass capacitors to ground. When using the V_{BB0} or V_{BB1} reference outputs, bypass each one with a $0.01\mu F$ ceramic capacitor to V_{CC} . If the V_{BB0} or V_{BB1} reference outputs are not used, they can be left open.

Traces

Circuit board trace layout is very important to maintain the signal integrity of high-speed differential signals. Maintaining integrity is accomplished in part by reducing signal reflections and skew, and increasing common-mode noise immunity.

Signal reflections are caused by discontinuities in the 50Ω characteristic impedance of the traces. Avoid discontinuities by maintaining the distance between differential traces, not using sharp corners or using vias. Maintaining distance between the traces also increases common-mode noise immunity. Reducing signal skew is accomplished by matching the electrical length of the differential traces.

Chip Information

TRANSISTOR COUNT: 485

PROCESS: Bipolar

Functional Diagram

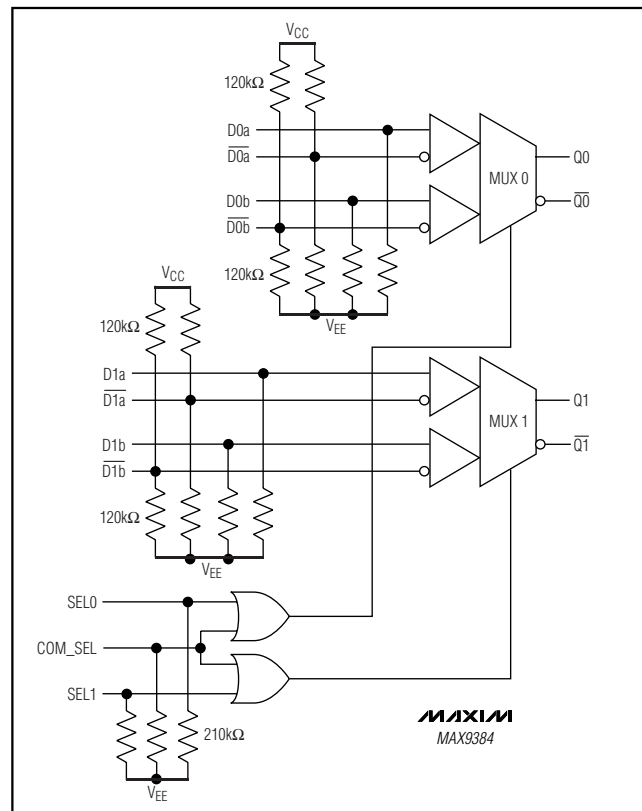

ECL/PECL Dual Differential 2:1 Multiplexer

Package Information

(The package drawing(s) in this data sheet may not reflect the most current specifications. For the latest package outline information, go to www.maxim-ic.com/packages.)

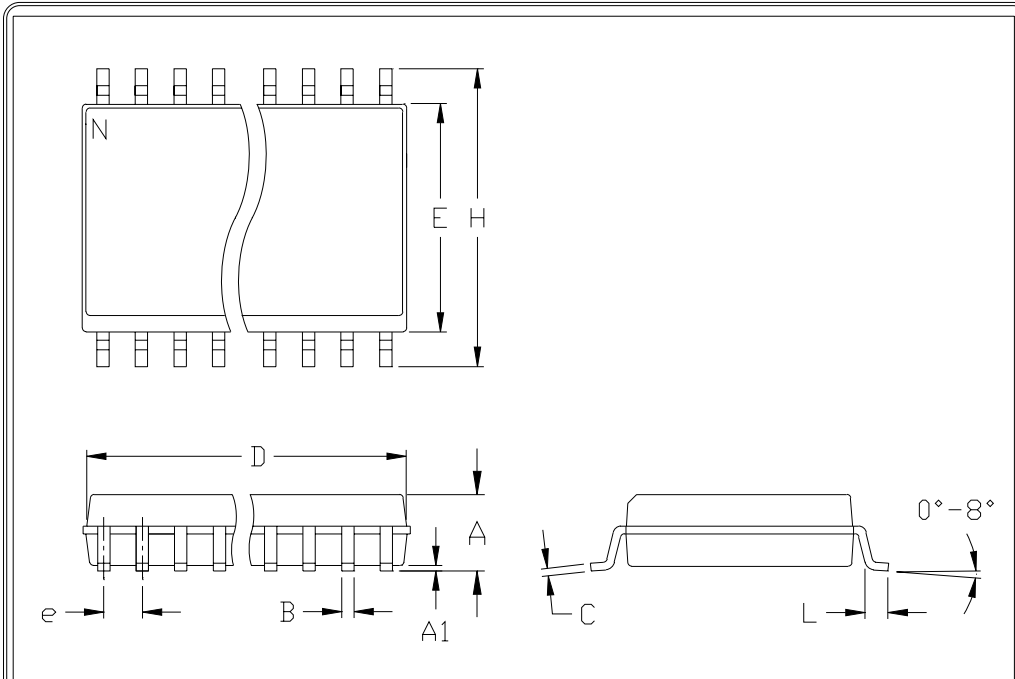

	INCHES		MILLIMETERS	
	MIN	MAX	MIN	MAX
A	0.093	0.104	2.35	2.65
A1	0.004	0.012	0.10	0.30
B	0.014	0.019	0.35	0.49
C	0.009	0.013	0.23	0.32
e	0.050		1.27	
E	0.291	0.299	7.40	7.60
H	0.394	0.419	10.00	10.65
h	0.010	0.030	0.25	0.75
L	0.016	0.050	0.40	1.27

	INCHES		MILLIMETERS		N	MS013
	MIN	MAX	MIN	MAX		
D	0.398	0.413	10.10	10.50	16	AA
D	0.447	0.463	11.35	11.75	18	AB
D	0.496	0.512	12.60	13.00	20	AC
D	0.598	0.614	15.20	15.60	24	AD
D	0.697	0.713	17.70	18.10	28	AE

NOTES:

1. D&E DO NOT INCLUDE MOLD FLASH
2. MOLD FLASH OR PROTRUSIONS NOT TO EXCEED .15mm (.006")
3. LEADS TO BE COPLANAR WITHIN .102mm (.004")
4. CONTROLLING DIMENSION: MILLIMETER
5. MEETS JEDEC MS013-XX AS SHOWN IN ABOVE TABLE
6. N = NUMBER OF PINS



PACKAGE FAMILY OUTLINE: SOIC .300"
TITLE

1/1

21-0042 A
DOCUMENT CONTROL NUMBER REV

Maxim cannot assume responsibility for use of any circuitry other than circuitry entirely embodied in a Maxim product. No circuit patent licenses are implied. Maxim reserves the right to change the circuitry and specifications without notice at any time.

10 Maxim Integrated Products, 120 San Gabriel Drive, Sunnyvale, CA 94086 408-737-7600