



# MAX3514/MAX3516/MAX3517 Evaluation Kits

## General Description

The MAX3514/MAX3516/MAX3517 evaluation kits (EV kits) simplify evaluation of the MAX3514/MAX3516/MAX3517 CATV upstream amplifiers. Each kit includes a data interface that can be programmed through the parallel port of a standard PC. Software (Windows® 95/98 compatible) is included to facilitate this function. This software allows the user to program both the gain and transmit modes through a simple user interface.

Access to the device input and output is provided through 50Ω SMA connectors. The input is matched to 50Ω, while the output circuit includes a minimum-loss pad that presents a 75Ω load to the output transformer when using 50Ω test equipment.

Windows is a registered trademark of Microsoft Corp.

## Features

- ◆ +5V Single-Supply Operation
- ◆ Output Level Range up to 64dBmV (QPSK)
- ◆ Gain Programmable in 0.5dB Steps
- ◆ Transmit-Disable Mode
- ◆ Shutdown Mode
- ◆ Control Software Included
- ◆ Fully Assembled and Tested Surface-Mount Board

## Ordering Information

PART	TEMP RANGE	IC PACKAGE
MAX3514EVKIT	-40°C to +85°C	20 QSOP
MAX3516EVKIT	-40°C to +85°C	20 TSSOP-EP*
MAX3517EVKIT	-40°C to +85°C	20 QSOP

\* Exposed paddle.

## Component List—MAX3514

DESIGNATION	QTY	DESCRIPTION
C1, C6	2	Leave site open
C2, C5, C8, C9, C11	5	0.1μF ±10% ceramic capacitors (0603) Murata GRM39X7R104K016A
C3, C4	2	1000pF ±10% ceramic capacitors (0603) Murata GRM39X7R102K050A
C7	1	10μF ±10%, 16V min tantalum capacitor AVX TAJC106K016
R1	1	49.9Ω ±1% resistor (0603)
R2, R3, R4, R6–R13, R16–R19	15	Leave site open
R5	1	43.2Ω ±1% resistor (0805)
R14, R15	2	100kΩ ±5% resistors (0603)
R21	1	86.6Ω ±1% resistor (0805)
L1	1	0Ω resistor (0805)
B3–B6	4	Murata BLM21A601RPT
T1	1	Transformer 1 to 1 Macom ECT1-1T

DESIGNATION	QTY	DESCRIPTION
T2	1	Transformer 2 to 1 voltage ratio, type B5F Toko 348PT-1087
U1	1	MAX3514EEP 20-pin QSOP
J1	1	SMA connector (PC mount) Johnson 142-0701-201 or Digi-Key J502-ND
J2	1	DB25 connector, right angle – female Digi-Key A2102-ND or AMP 745783-4
JU1–JU7	7	1 × 3 pin headers (0.1in centers) Digi-Key S1012-36-ND
JU1–JU7	7	Shunts, Digi-Key S9000-ND
IN1, IN2	2	Test points, Digi-Key 5000K-ND
None	1	MAX3514/MAX3517 EV kit circuit board, Rev. 2
None	1	MAX3514/MAX3516/MAX3517 software disk
None	1	MAX3514/MAX3516/MAX3517 data sheet
None	1	MAX3514/MAX3516/MAX3517 EV kit data sheet



# MAX3514/MAX3516/MAX3517 Evaluation Kits

Evaluate: MAX3514/MAX3516/MAX3517

## Component List—MAX3516

DESIGNATION	QTY	DESCRIPTION
C1, C4, C6, C8, C9	5	0.1μF ±10% ceramic capacitors (0805) Murata GRM40X7R104K016A
C2, C3	2	1000pF ±10% ceramic capacitors (0805) Murata GRM40102K050A
C5, C10	2	Open
C7	1	10μF tantalum capacitor ±10%, 16V min AVX TAJC106K016
R1	1	49.9 Ω ±1% resistor (0402)
R2, R3, R4, R6–R13, R16–R19, R22, R23	17	Open
R5	1	43.2Ω ±1% resistor (0805)
R14, R15	2	100kΩ ±5% resistors (0805)
R21	1	86.6Ω ± 1% resistor (0805)
B1, B2	2	0Ω resistors (0805)
B3–B6	4	BLM21A601RPT Murata
T1	1	1-to-1 transformer Macom ETC1-1T
T2	1	4-to-1 transformer type B5F TOKO 458PT-1087
U1	1	MAX3516EUP, 20-pin TSSOP-EP
J2	1	DB25 connector, right angle, female Digi-Key A2102-ND
J1, J3	2	SMA connectors (edge mount) EFJohnson 142-0701-801 Digi-Key J502-ND <b>Note:</b> Cut center pin to approximately 1/16in length.
JU1–JU7	7	1 × 3 pin headers (0.1in centers) Digi-Key S1012-36-ND
JU1–JU7	7	Shunts Digi-Key S9000-ND
IN1, IN2	2	Test points Digi-Key 5000K-ND
None	1	MAX3516 EV kit circuit board, Rev A
None	1	MAX3514 software disk
None	1	MAX3516 data sheet
None	1	MAX3516 EV kit data sheet

## Component List—MAX3517

DESIGNATION	QTY	DESCRIPTION
C1, C6	2	Leave site open
C2, C5, C8, C9, C11	5	0.1μF ±10% ceramic caps (0603) Murata GRM39X7R104K016A
C3, C4	2	1000pF ±10% ceramic caps (0603) Murata GRM39X7R102K050A
C7	1	10μF ±10%, 16V min tantalum cap AVX TAJC106K016
R1	1	49.9Ω ±1% resistor (0603)
R2, R3, R4, R6–R13, R18, R19	13	Leave site open
R5	1	43.2Ω ±1% resistor (0805)
R14, R15	2	100kΩ ±5% resistors (0603)
R16, R17	2	300Ω ±5% resistors (0603)
R21	1	86.6Ω ±1% resistor (0805)
L1	1	0Ω resistor (0805)
B3–B6	4	Murata BLM21A601RPT
T1	1	Transformer 1 to 1 Macom ECT1-1T
T2	1	Transformer 2 to 1 voltage ratio, type B5F, Toko 348PT-1087
U1	1	MAX3517EEP 20-pin QSOP
J1, J3	2	SMA connectors (PC mount) Johnson 142-0701-201 or Digi-Key J502-ND
J2	1	DB25 connector, right angle – female, Digi-Key A2102-ND or AMP 745783-4
JU1–JU7	7	1 × 3 pin headers (0.1in centers) Digi-Key S1012-36-ND
JU1–JU7	7	Shunts, Digi-Key S9000-ND
IN1, IN2	2	Test points, Digi-Key 5000K-ND
None	1	MAX3514/MAX3517 EV kit circuit board, Rev. 2
None	1	MAX3514/MAX3516/MAX3517 software disk
None	1	MAX3514/MAX3516/MAX3517 data sheet
None	1	MAX3514/MAX3516/MAX3517 EV kit data sheet

# MAX3514/MAX3516/MAX3517 Evaluation Kits

Evaluate: MAX3514/MAX3516/MAX3517

**Table 1. Jumper Setting Functions**

JUMPER	FUNCTION	SHORT PIN1 TO PIN2	SHORT PIN2 TO PIN3
JU1	Set the method of control of $\overline{\text{SHDN}}$	PC port control	Manual control through JU2
JU2	Set the manual control state of $\overline{\text{SHDN}}$	Logic 1 state ( $V_{CC}$ )	Logic 0 state (GND)
JU3	Set the method of control of TXEN	PC port control	Manual control through JU4
JU4	Set the manual control state of TXEN	Logic 1 state ( $V_{CC}$ )	Logic 0 state (GND)
JU5	$\overline{\text{CS}}$ input	PC port control	N/A
JU6	SDA input	PC port control	N/A
JU7	SCLK input	PC port control	N/A

## Quick Start

The MAX3514/MAX3516/MAX3517 EV kits are fully assembled and factory tested. Follow the instructions in the *Connections and Setup* section. **Note:** The output circuit includes a minimum-loss pad that is used to bring the load impedance up to 75Ω. This must be accounted for in all measurements (see *Output Circuit* section).

**Note:** The input transformer is supplied to allow differential input drive from a single-ended source. A transformer is not required in the application.

## Test Equipment Required

- DC supply capable of delivering 5.5V and 200mA of continuous current
- HP 8648 or equivalent signal source capable of generating 40dBmV up to 200MHz
- HP 8561E or equivalent spectrum analyzer with a minimum 200MHz frequency range
- Digital multimeter (DMM) to monitor  $V_{CC}$  and  $I_{CC}$ , if desired
- Lowpass filters to attenuate harmonic output of signal sources, if harmonic measurements are desired
- Network analyzer, such as the HP 8753D (may be used to measure gain and harmonic levels if configured with this option; contact test equipment manufacturer)
- IBM PC or compatible with Windows 95/98 installed
- Male-to-male 25-pin parallel cable, straight through
- 0 to 5V pulse generator (transient measurement)
- Low-noise amplifier with 40dB gain from 5MHz to 100MHz (noise measurement)
- Oscilloscope with 200MHz bandwidth

## Connections and Setup

- 1) Connect the power supply (preset to +5V) to the

**Table 2. MAX3514/MAX3516/MAX3517 EV Kit Software**

FILENAME	DESCRIPTION
Max3514.txt	"Read Me" text file
Max3514.exe	Windows executable
Max3510.dll	DLL file for printer port control
Msvbvm50.dll	DLL file

pins labeled +5V and GND on the circuit board. Connect a 50Ω signal source to INPUT (preset the signal source for -13dBm (+34dBmV across a 50Ω load)), and terminate OUTPUT with a spectrum analyzer or network analyzer having a 50Ω input impedance. If using a signal source with a source impedance other than 50Ω, or if a different input impedance is required, be sure to replace resistor R1 with the appropriate value resistor.

- 2) Connect a 25-pin male-to-male cable between the parallel (printer) port of the PC and the 25-pin female connector on the EV kit board.
- 3) See Table 1 for board jumper settings.
- 4) Turn on the power supply. Turn on the PC and the test equipment.
- 5) Run the software program.

## Detailed Description

### Using the Software

The MAX3514/MAX3516/MAX3517 use a serial data interface (SDI) to set gain. Some means of communicating with the SDI is required to use the MAX3514/MAX3516/MAX3517 EV kits. A microprocessor, pattern generator, or PC can be used for this function.

Software is included in these EV kits to facilitate the use of a PC.

# MAX3514/MAX3516/MAX3517 Evaluation Kits

The disks included with the MAX3514/MAX3516/MAX3517 EV kits contain four files each. Table 2 lists these files and their appropriate usage. If your PC has Windows 95/98 installed, run MAX3514.EXE. The software can also be found on the Maxim website.

## Gain Adjustment

The valid gain code ranges from 0 to 127 (decimal). The nominal change in gain is 0.5dB per gain code. Gain codes are set exclusively by programming the SDI. Refer to the MAX3514/MAX3516/MAX3517 data sheet for details.

## High Power and Low Noise

High-power (HP) mode and low-noise (LN) mode may only be controlled via the PC interface. Manual control of the jumpers for the EV kits' boards is not possible. For DOCSIS applications, HP mode should be used for output levels above 42dBmV. This corresponds to gain code 87. LN mode should be used below this output level. This corresponds to gain code 115. A transition from HP mode, gain code 87, to LN mode, gain code 117, will result in a -1dB step.

## Shutdown and Transmit Enable

Jumpers JU1 through JU4 determine how the shutdown and transmit-enable features are controlled. Pin 2 of JU2 and pin 2 of JU4 are connected directly to the device. If an external source (such as a modulator chip or microprocessor) is used to control these features, make the connections to pin 2 of JU2 and pin 2 of JU4. Pads are provided on the board (R18 and R19, respectively) for placement of termination resistors, if needed.

If manual control of shutdown and transmit enable is desired, shunt pins 2 and 3 of jumper JU1 and pins 2 and 3 of jumper JU3. This will allow  $\overline{\text{SHDN}}$  and TXEN to be controlled by JU2 and JU4, respectively. JU2 and JU4 are used to place either  $V_{CC}$  or ground at  $\overline{\text{SHDN}}$  or TXEN. Pin 3 of JU2 and pin 3 of JU4 are ground, and pin 1 is  $V_{CC}$ .

To control the  $\overline{\text{SHDN}}$  and TXEN features using the software, shunt pin 1 and pin 2 of JU1 and JU3.

## Manual Control of Serial Data Interface

If using a source other than a PC to drive the serial data interface of the MAX3514/MAX3516/MAX3517 EV kits (such as a digital pattern generator or microprocessor), remove the shunts on jumpers JU5, JU6, and JU7. Access to the serial data interface is available through these jumpers. Termination pads are provided (R2, R3, R4). Solder an appropriate resistor to these pads, if desired. Refer to the MAX3514/MAX3516/MAX3517 data sheet for a description of the serial data interface.

To control the SDI using the software, shunt pin 1 and pin 2 of JU5, JU6, and JU7.

## Input Circuit

The input circuits of the MAX3514/MAX3516/MAX3517 EV kits are configured with a 1:1 transformer (T1) and a 49.9 $\Omega$  input resistor. This allows the input to be driven with single-ended 50 $\Omega$  test equipment. The transformer (T1) is used to generate a differential signal, as rated performance is specified with a differential input drive (typically from a differential lowpass filter).

If the MAX3514/MAX3516/MAX3517 are to be driven single ended, the input transformer (T1) must be removed and the undriven input connected to ground through a 0.1 $\mu\text{F}$  blocking capacitor.

## Output Circuit

The MAX3514/MAX3516/MAX3517 have differential outputs. This architecture aids in suppressing second-order distortion (harmonics). To convert to a single-ended output, a 2:1 voltage ratio transformer (T2) is used. Since most test equipment is supplied with a 50 $\Omega$  termination impedance, a minimum-loss pad is provided on the output of the transformer to increase the load impedance to a nominal 75 $\Omega$ . This places the proper load on the device, but will also reduce the measured output voltage level by 7.5dB. It is essential to consider this when making any measurements with the EV kit; 7.5dB must be added to all measurements of voltage gain and output voltage level (including noise) to arrive at the correct value for a 75 $\Omega$  system.

Use 75 $\Omega$  test equipment, if available, and take the following steps:

- 1) Remove the 50 $\Omega$  output SMA connector and replace it with a 75 $\Omega$  connector.
- 2) Remove R5 and replace it with a 0 $\Omega$  resistor or some other type of shunt.
- 3) Remove R21.
- 4) Be sure to use a 75 $\Omega$  cable.

## Analysis

### Harmonic Distortion

A filter will be needed to reject the harmonics generated by the signal source. For this example, a lowpass filter with approximately a 25MHz to 35MHz cutoff frequency will be required. This filter will need to reject at least 20dB of signal at 40MHz. Set the 50 $\Omega$  signal source for 20MHz and -13dBm. Adjust the amplitude to account for the insertion loss in the filter. Verify with the spectrum analyzer that the second and third harmonics generated by the source are suppressed by at least 70dBc.

# MAX3514/MAX3516/MAX3517 Evaluation Kits

Connect the filter between INPUT of the EV kit and the output of the signal source, making sure the proper terminations are being used for this particular filter.

Connect a spectrum analyzer to OUTPUT. Set the center frequency for 40MHz and the span for 50MHz or more. Adjust the reference level so that the fundamental (20MHz tone) is within 10dB to 20dB of the reference level. If the fundamental is less than 10dB below the reference level, the harmonic distortion of the spectrum analyzer may prevent accurate measurement of the distortion.

Set the gain code to 125,  $D7 = 1$  (approximately 27dB of gain). Measure the level of the fundamental, second, and third harmonics on the spectrum analyzer. These readings have units of dBm. To convert from dBm to dBmV in a  $50\Omega$  system, use the following equation:

$$X \text{ (dBmV)} = Y \text{ (dBm)} + 47\text{dB (} 50\Omega \text{ system)}$$

Add 7.5dB to this value to account for the attenuation of the minimum-loss pad, in dBmV, for a  $75\Omega$  load. The gain can now be calculated in dB, and the harmonic distortion can be calculated in dBc.

## Switching Transients

To measure the transmit-enable and transmit-disable transients, the TXEN pin will be driven from an external source. No input signal is applied, and the output is viewed on an oscilloscope.

Connect OUTPUT to the oscilloscope's  $50\Omega$  input. Set the scope's time base to  $5\mu\text{s}/\text{div}$  and the vertical scale to  $5\text{mV}/\text{div}$ .

Set the pulse generator as follows:

- Amplitude: 5V
- Duty cycle: 50%
- Rise/fall-time: 100ns
- Pulse width: 25 $\mu\text{s}$
- Offset: 2.5V

Take care not to drive the MAX3514/MAX3516/MAX3517 TXEN pin below 0 or above +5V. Turn on the power supply. Remove the shunt from jumper JU3 (TXEN), and connect the output of the pulse generator to pin 2 of this jumper. Trigger the oscilloscope from the pulse generator using a convenient method.

Set the gain code to 125,  $D7 = 1$ .

A rising- and falling-edge transient should appear on the scope's CRT. The amplitude of this transient should be less than 40mVp-p. Multiply the value of the measured transient by 2.37 to account for the presence of the minimum-loss pad. The gain may now be changed to show the output transient's dependence on gain.

## Output Noise

To measure output noise, a spectrum analyzer is used. A postamplifier with less than 10dB noise figure and greater than 40dB gain within the band of interest is needed.

With the power supply off, place a  $50\Omega$  termination on the input of the EV kit.

Turn on the power supply to the MAX3514/MAX3516/MAX3517 EV kits. Using the software, set the device to transmit mode with a gain code of 119,  $D7 = 1$  (approximately 24dB of gain, MAX3514). Connect the output of the postamplifier to the spectrum analyzer and the input to OUTPUT on the EV kit. Set the spectrum analyzer as follows:

- Center frequency: 35MHz
- Span: 60MHz
- Reference: -50dBm
- Scale: 10dB/div
- IF bandwidth: 1kHz

Power up the postamplifier.

If the spectrum analyzer being used has a noise marker function, enable it. The output noise can now be read directly from the spectrum analyzer. Move this marker to 42MHz. Read the value of the noise density from the spectrum analyzer. This noise value is a combination of the output noise of the MAX3514/MAX3516/MAX3517, the gain of the postamplifier, and the noise figure of the postamplifier. With the specified noise figure of 10dB, the noise contribution of the postamplifier may be ignored. The minimum-loss pad reduces the actual measured value by 7.5dB. Use the following equation to arrive at the MAX3514/MAX3516/MAX3517's output noise in a 160kHz bandwidth:

$$\text{VNOISE} = \text{PNOISE} + 47\text{dB} + 7.5\text{dB} + 10 \times \log(160,000) - \text{GAMP}$$

where:

VNOISE = MAX3514/MAX3516/MAX3517 output noise in dBmV measured in a 160kHz bandwidth

PNOISE = Noise density in dBm/Hz read from the spectrum analyzer

GAMP = Gain of the postamplifier in dB

If the spectrum analyzer being used does not have a noise marker function, corrections must be made to account for the IF bandwidth used to make the measurement. Consult the user's manual for your spectrum analyzer for details. Once the correction is made, the value read from the spectrum analyzer can be converted to a noise density (dBm/Hz), and the above formula can be used.



# MAX3514/MAX3516/MAX3517 Evaluation Kits

Noise can now be measured at various gains. Output noise in transmit-disable mode is insignificant.

## Layout Considerations

The MAX3514/MAX3516/MAX3517 evaluation board can serve as a guide for your board layout. Particular attention should be paid to thermal design and to the output network. The MAX3514/MAX3516/MAX3517 package exposed paddle (EP) conducts heat out of the part and also provides a low-impedance electrical connection. The EP must be attached to the PC board ground plane with a low thermal and electrical impedance contact. Ideally, this would be provided by soldering the backside package contact directly to a top metal ground plane on the PC board. Alternatively, the EP could be connected to a ground plane using an array of plated vias directly below EP.

## Component Suppliers

SUPPLIER	PHONE	FAX
AVX	803-946-0690	803-626-3123
M/A-COM	978-442-5000	978-442-4178
Murata	814-237-1431	814-238-0490
TOKO	847-297-0076	847-297-7864

The output circuit that connects OUT+ and OUT- (pins 15 and 16) to the output transformer (T2) should be as symmetrical as possible to reduce second-order distortion. In addition, the capacitance of this path should be kept low to minimize gain rolloff at high frequencies.

## Functional Diagram

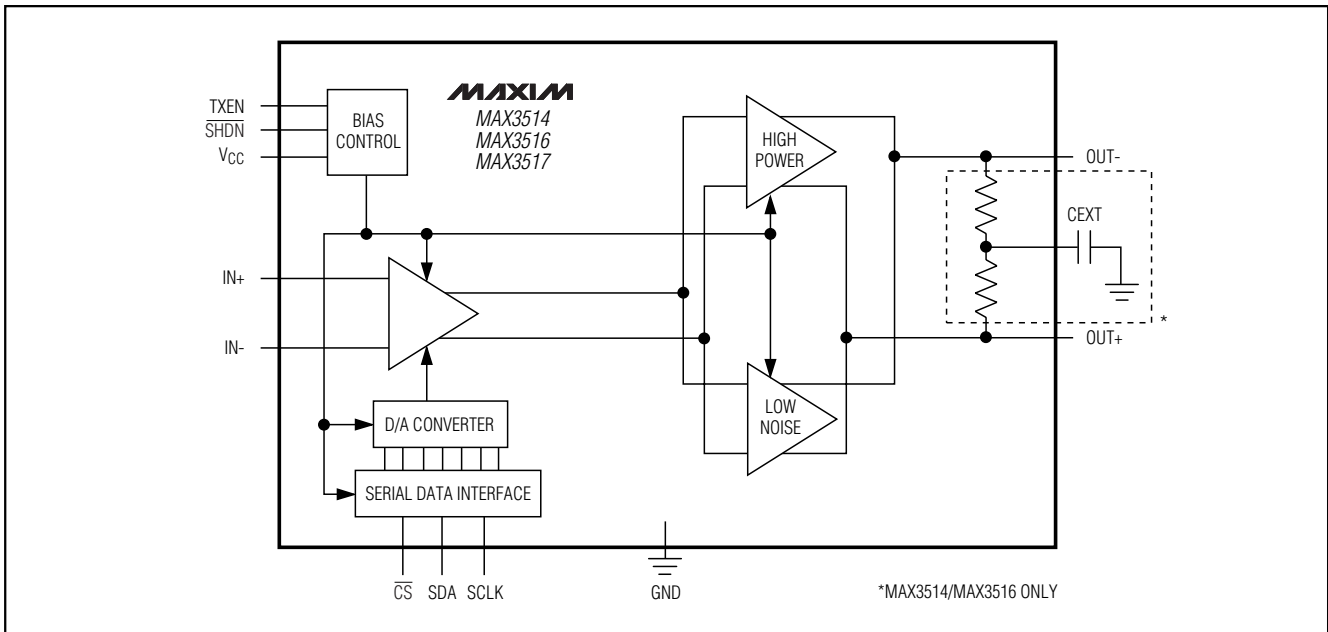

# MAX3514/MAX3516/MAX3517 Evaluation Kits

Evaluate: MAX3514/MAX3516/MAX3517

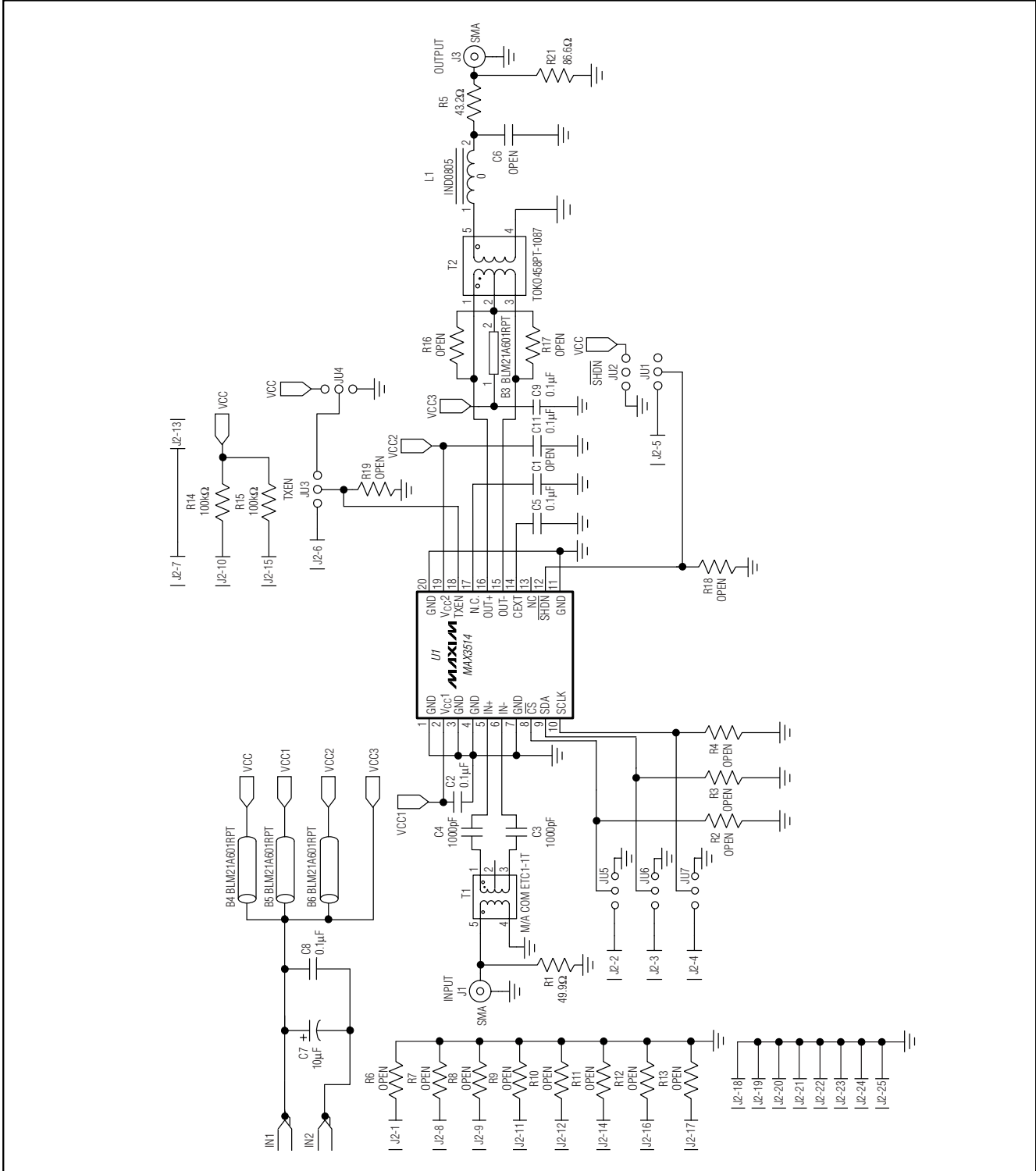

Figure 1. MAX3514 EV Kit Schematic

# MAX3514/MAX3516/MAX3517 Evaluation Kits

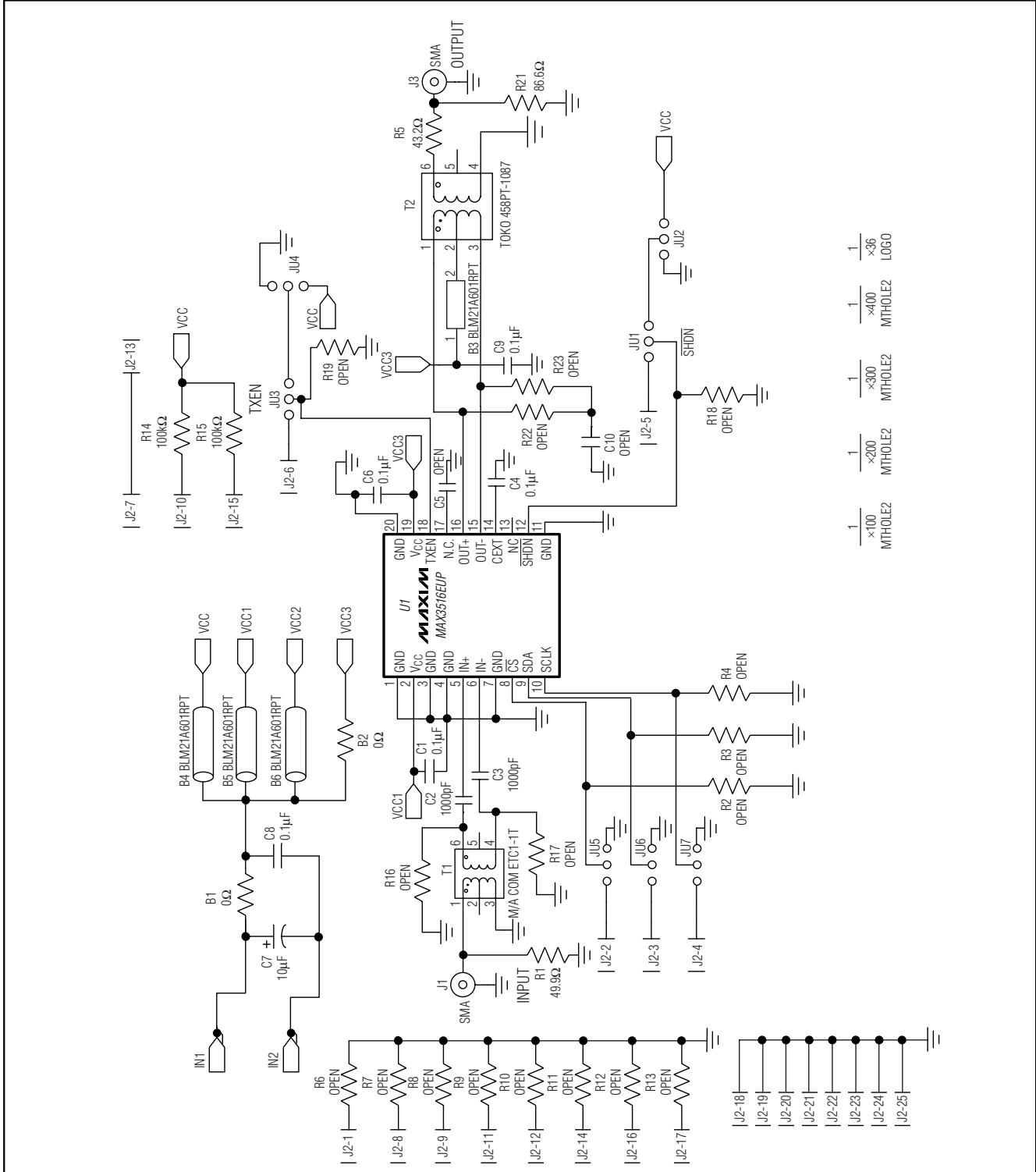

Figure 2. MAX3516 EV Kit Schematic





# MAX3514/MAX3516/MAX3517 Evaluation Kits

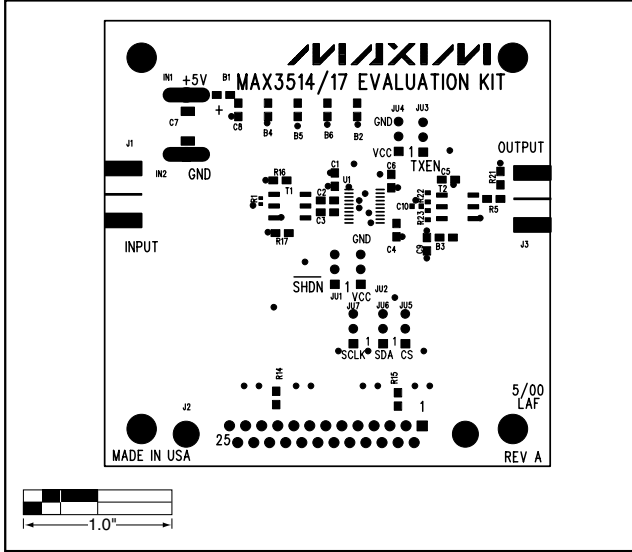

Figure 4. MAX3514/MAX3517 EV Kit Component Placement Guide—Component Side

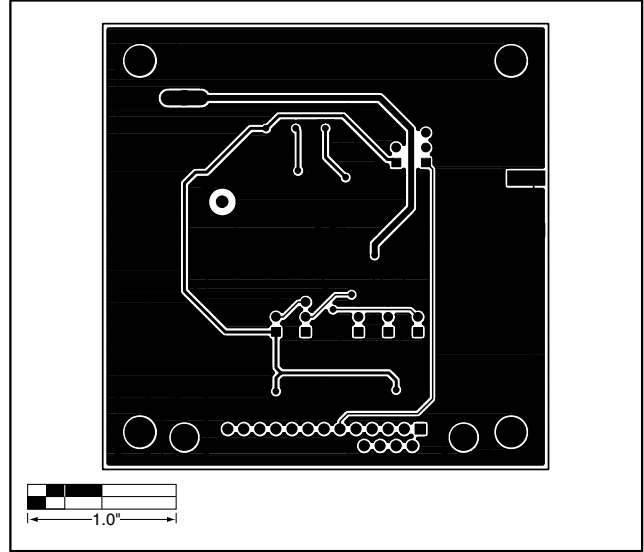

Figure 5. MAX3514/MAX3517 EV Kit PC Board Layout—Solder Side

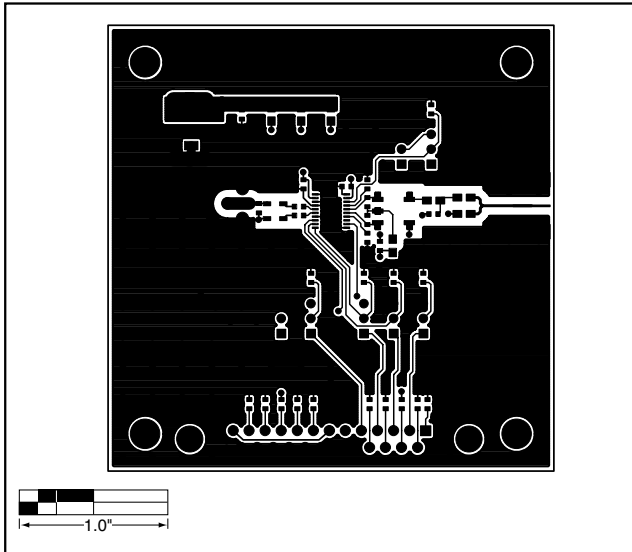

Figure 6. MAX3514/MAX3517 EV Kit PC Board Layout—Solder Side

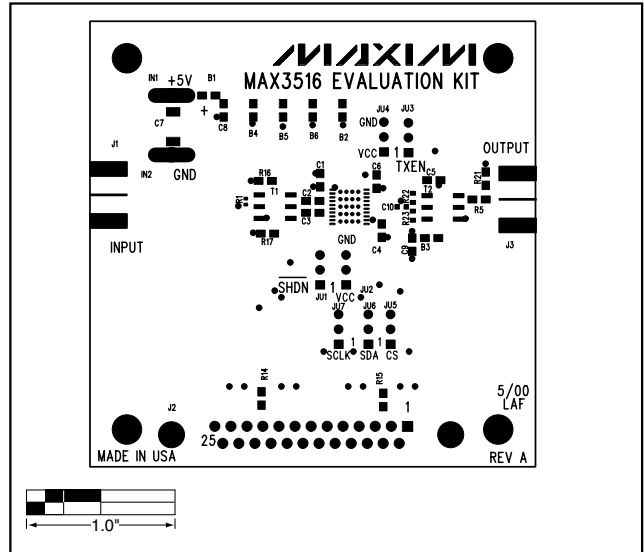

Figure 7. MAX3516 EV Kit Component Placement Guide—Component Side

# MAX3514/MAX3516/MAX3517 Evaluation Kits

Evaluate: MAX3514/MAX3516/MAX3517

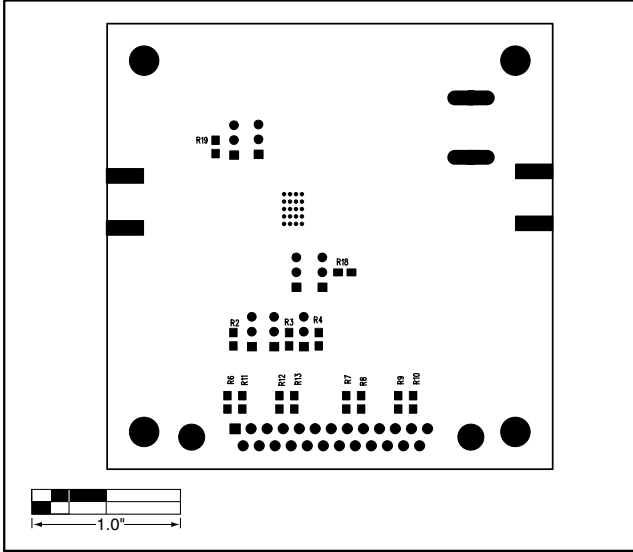

Figure 8. MAX3516 EV Kit PC Board Layout—Solder Side

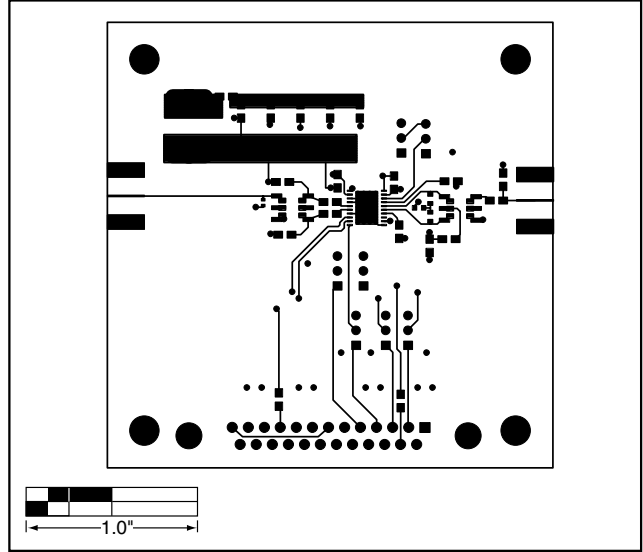

Figure 9. MAX3516 EV Kit PC Board Layout—Component Side

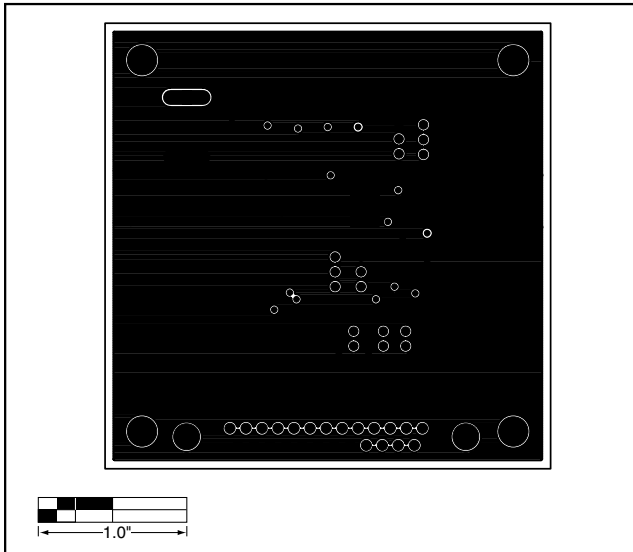

Figure 10. MAX3516 EV Kit PC Board Layout—Ground Plane

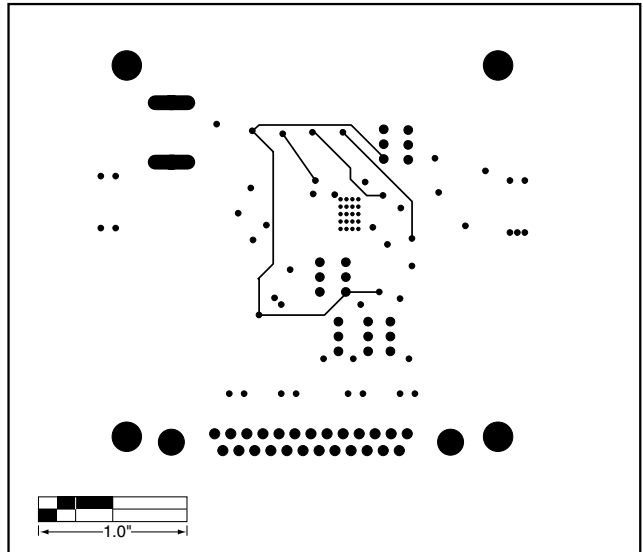

Figure 11. MAX3516 EV Kit PC Board Layout—Power Plane

# MAX3514/MAX3516/MAX3517 Evaluation Kits

**Evaluate: MAX3514/MAX3516/MAX3517**

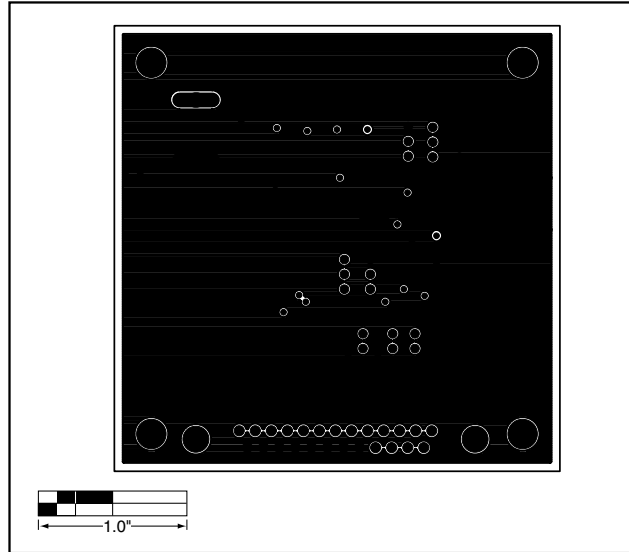

Figure 12. MAX3516 EV Kit PC Board Layout—Ground Plane

Maxim cannot assume responsibility for use of any circuitry other than circuitry entirely embodied in a Maxim product. No circuit patent licenses are implied. Maxim reserves the right to change the circuitry and specifications without notice at any time.

12 \_\_\_\_\_ **Maxim Integrated Products, 120 San Gabriel Drive, Sunnyvale, CA 94086 408-737-7600**