

SPDT NON-REFLECTIVE SWITCH, DC - 4.0 GHz

Typical Applications

The HMC435MS8G is ideal for:

- Basestation Infrastructure
- MMDS & 3.5 GHz WLL
- CATV/CMTS
- Test Instrumentation

Features

- High Isolation: 60 dB @ 1 GHz
50 dB @ 2 GHz
- Positive Control: 0/+5V
- 51 dBm Input IP3
- Non-Reflective Design
- MS8G SMT Package, 14.8 mm²

Functional Diagram

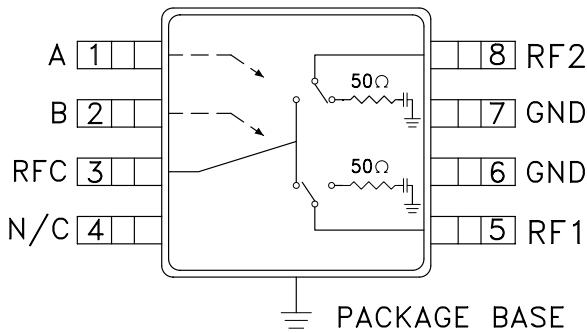

General Description

The HMC435MS8G is a non-reflective DC to 4 GHz GaAs MESFET SPDT switch in a low cost 8 lead MSOP8G surface mount package with an exposed ground paddle. The switch is ideal for cellular/PCS/3G basestation applications yielding 50 to 60 dB isolation, low 0.8 dB insertion loss and +50 dBm input IP3. Power handling is excellent up through the 3.5 GHz WLL band with the switch offering a P1dB compression point of +31 dBm. On-chip circuitry allows positive voltage control of 0/+5 Volts at very low DC currents.

Electrical Specifications, $T_A = +25^\circ C$, $V_{ctl} = 0/+5 V_{dc}$, 50 Ohm System

Parameter	Frequency	Min.	Typ.	Max.	Units
Insertion Loss	DC - 2.5 GHz		0.8	1.0	dB
	DC - 3.6 GHz		1.2	1.5	dB
	DC - 4.0 GHz		1.5	1.8	dB
Isolation (RFC to RF1/RF2)	DC - 1.0 GHz	56	60		dB
	DC - 2.0 GHz	46	50		dB
	DC - 2.5 GHz	43	47		dB
	DC - 3.6 GHz	37	41		dB
	DC - 4.0 GHz	30	35		dB
Return Loss (On State)	DC - 2.5 GHz	15	20		dB
	DC - 3.6 GHz	13	17		dB
	DC - 4.0 GHz	11	15		dB
Return Loss (Off State)	0.5 - 4.0 GHz	16	21		dB
Input Power for 1 dB Compression	0.5 - 4.0 GHz	27	31		dBm
Input Third Order Intercept (Two-Tone Input Power = +7 dBm Each Tone)	0.5 - 1.0 GHz	48	51		dBm
	0.5 - 2.5 GHz	45	48		dBm
	0.5 - 4.0 GHz	41	45		dBm
Switching Speed	DC - 4.0 GHz				
		tRISE, tFALL (10/90% RF) tON, tOFF (50% CTL to 10/90% RF)	40 60		ns ns

For price, delivery, and to place orders, please contact Hittite Microwave Corporation:
12 Elizabeth Drive, Chelmsford, MA 01824 Phone: 978-250-3343 Fax: 978-250-3373
Order Online at www.hittite.com

SPDT NON-REFLECTIVE SWITCH, DC - 4.0 GHz

Insertion Loss

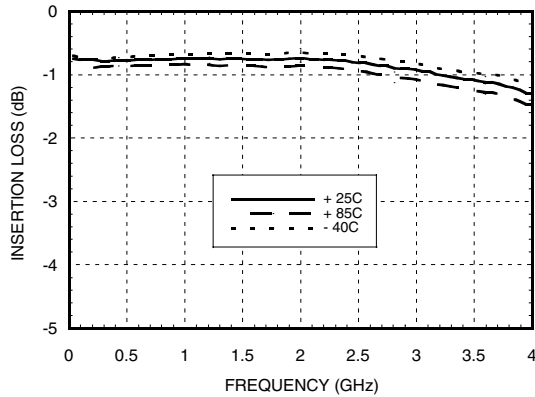

Return Loss

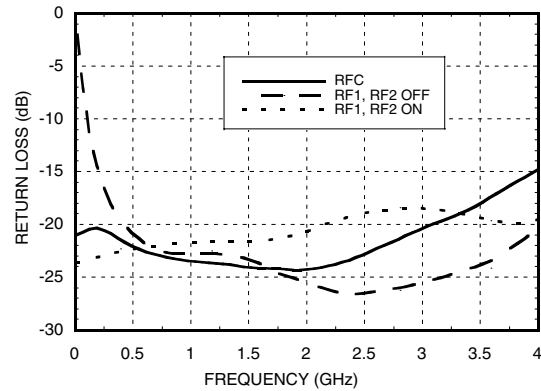

Isolation Between Ports RFC and RF1 / RF2

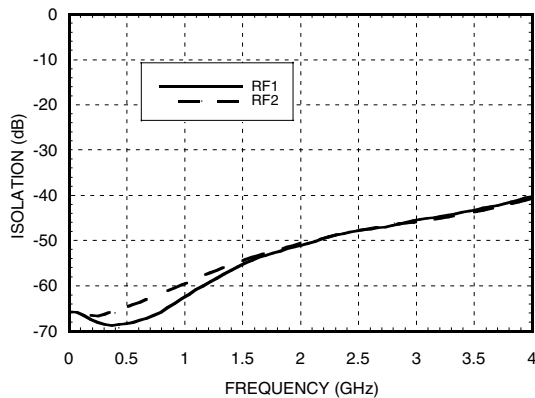

Isolation Between Ports RF1 and RF2

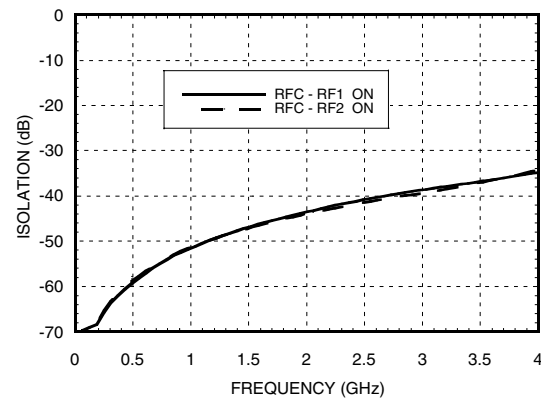

0.1 and 1 dB Input Compression Point

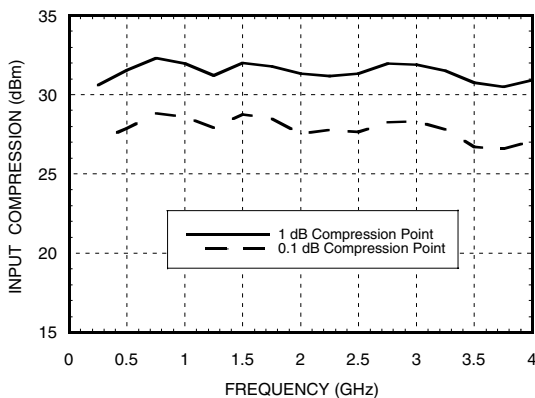

Input Third Order Intercept Point

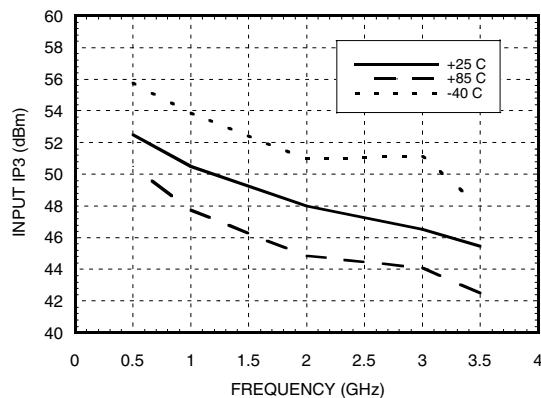

SPDT NON-REFLECTIVE SWITCH, DC - 4.0 GHz

Absolute Maximum Ratings

Control Voltage Range	-0.5 to +7.5 Vdc
Storage Temperature	-65 to +150 °C
Operating Temperature	-40 to +85 °C
RF Input Power Vctl = 0/+5V	+31 dBm

Control Voltages

*Control Input Tolerances are ± 0.2 Vdc

State	Bias Condition*
Low	0 Vdc @ 25 μ A Typical
High	+5 Vdc @ 25 μ A Typical

Truth Table

Control Input		Signal Path State
A	B	RFC to:
Low	High	RF1
High	Low	RF2

DC blocks are required at ports RFC, RF1, RF2.

Do not operate continuously at RF power input greater than 1 dB compression and do not "Hot Switch" power levels greater than +24 dBm (control = 0/+5 Vdc).

Outline Drawing

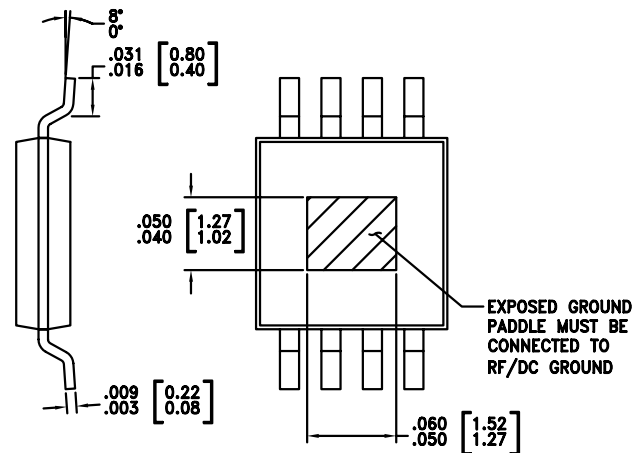
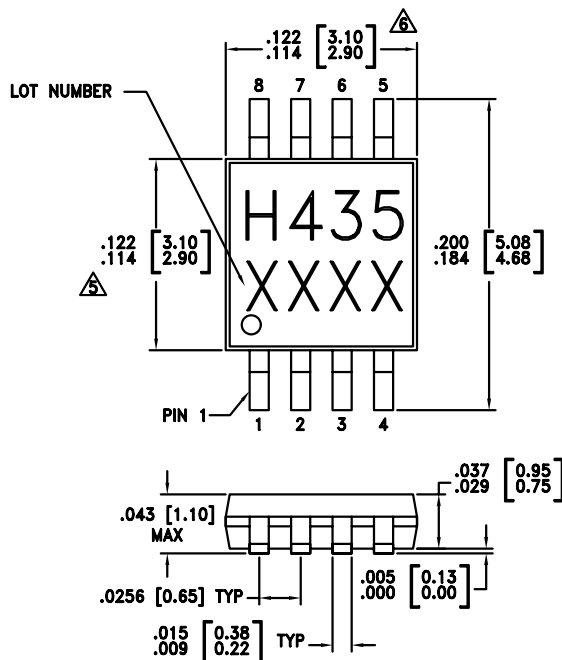



NOTES:

- PACKAGE BODY MATERIAL: LOW STRESS INJECTION MOLDED PLASTIC SILICA AND SILICON IMPREGNATED.
- LEADFRAME MATERIAL: COPPER ALLOY
- LEADFRAME PLATING: Sn/Pb SOLDER
- DIMENSIONS ARE IN INCHES [MILLIMETERS].
- \triangle DIMENSION DOES NOT INCLUDE MOLDFLASH OF 0.15mm PER SIDE.
- \triangle DIMENSION DOES NOT INCLUDE MOLDFLASH OF 0.25mm PER SIDE.
- ALL GROUND LEADS AND GROUND PADDLE MUST BE SOLDERED TO PCB RF GROUND.

SPDT NON-REFLECTIVE SWITCH, DC - 4.0 GHz

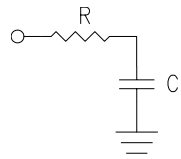
Pin Descriptions

Pin Number	Function	Description	Interface Schematic
1	A	See truth and control voltage tables.	
2	B	See truth and control voltage tables.	
3, 5, 8	RFC, RF1, RF2	These pins are DC coupled and matched to 50 Ohms. Blocking capacitors are required.	
4	N/C	Not Connected	
6, 7	GND	Package bottom has exposed metal paddle that must be connected to PCB RF ground as well.	

SPDT NON-REFLECTIVE SWITCH, DC - 4.0 GHz

Evaluation PCB

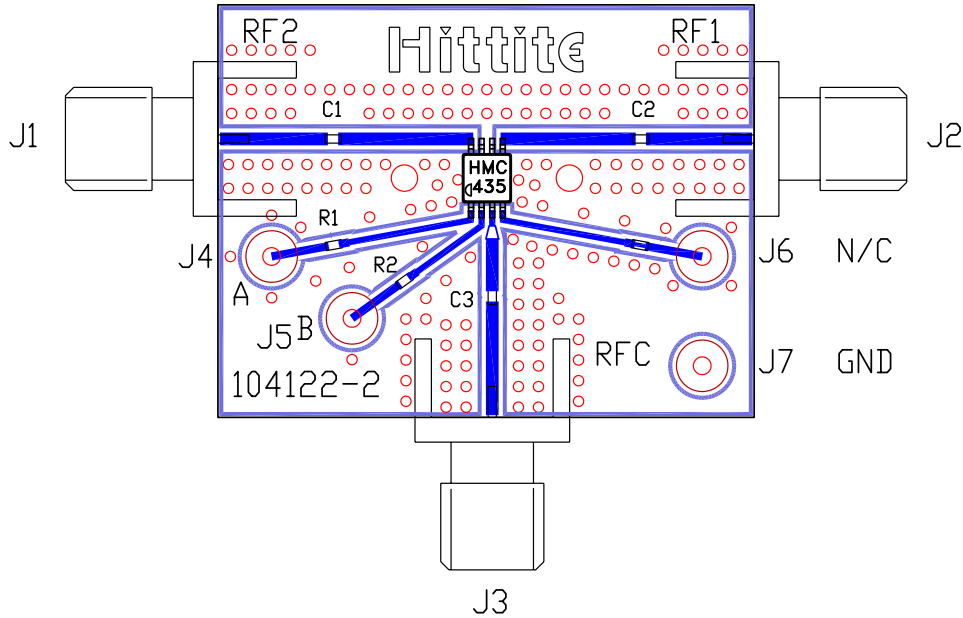

List of Material

Item	Description
J1 - J3	PC Mount SMA RF Connector
J4 - J7	DC Pin
C1 - C3	100 pF Capacitor, 0402 Pkg.
R1 - R2	100 Ohm Resistor, 0402 Pkg.
U1	HMC435MS8G SPDT Switch
PCB*	104122 Evaluation PCB
* Circuit Board Material: Rogers 4350	

Note: Pin J6 is unused and need not be connected.

The circuit board used in the final application should be generated with proper RF circuit design techniques. Signal lines at the RF port should have 50 ohm impedance and the package ground leads and backside ground slug should be connected directly to the ground plane similar to that shown above. The evaluation circuit board shown above is available from Hittite Microwave Corporation upon request.

SPDT NON-REFLECTIVE SWITCH, DC - 4.0 GHz

Notes: