

PHASE CONTROL SCR

	$V_T < 1.4V @ 100A$ $I_{TSM} = 1400A$ $V_{RRM} = 1200, 1600V$
---	---

Description/ Features

The 70TPS... **SAFEIR** series of silicon controlled rectifiers are specifically designed for high and medium power switching and phase control applications.

Typical applications are in input rectification (soft start) or AC-Switches or high current crow-bar as well as others phase-control circuits.

These products are designed to be used with International Rectifier input diodes, switches and output rectifiers which are available in identical package outlines.

Major Ratings and Characteristics

Characteristics	70TPS..	Units
$I_{T(AV)}$ Sinusoidal waveform	70	A
I_{RMS} (*)	75	A
V_{RRM}/V_{DRM} Range	1200, 1600	V
I_{TSM}	1400	A
$V_T @ 100A, T_J = 25^\circ C$	1.4	V
dv/dt	500	V/ μs
di/dt	150	A/ μs
T_J	-40 to 125	$^\circ C$

(*) Lead current limitation

Package Outline



Super-247

Voltage Ratings

Part Number	V_{RRM}/V_{DRM} , max. repetitive peak and off-state voltage V	V_{RSM} , maximum non repetitive peak reverse voltage V	I_{RRM}/I_{DRM} 125°C mA
70TPS12	1200	1300	15
70TPS16	1600	1700	

Absolute Maximum Ratings

Parameters	70TPS..	Units	Conditions	
$I_{T(AV)}$ Max. Average On-state Current	70	A	@ $T_C = 82^\circ\text{C}$, 180° conduction half sine wave	
$I_{T(RMS)}$ Max. Continuous RMS On-state Current As AC switch	75		Lead current limitation	
I_{TSM} Max. Peak One Cycle Non-Repetitive Surge Current	1200	A	10ms Sine pulse, rated V_{RRM} applied	Initial $T_J = T_{J\text{max}}$.
	1400		10ms Sine pulse, no voltage reapplied	
I^2t Max. I^2t for Fusing	7200	A^2s	10ms Sine pulse, rated V_{RRM} applied	
	10200		10ms Sine pulse, no voltage reapplied	
$I^2\sqrt{t}$ Max. $I^2\sqrt{t}$ for Fusing	102000	$A^2\sqrt{s}$	$t = 0.1$ to 10ms, no voltage reapplied	
$V_{T(TO)1}$ Low Level Value of Threshold Voltage	0.916	V	$T_J = 125^\circ\text{C}$	
$V_{T(TO)2}$ High Level Value of Threshold Voltage	1.21			
r_{t1} Low Level Value of On-state Slope Resistance	4.138			
r_{t2} High Level Value of On-state Slope Resistance	3.43			
V_{TM} Max. Peak On-state Voltage	1.4	V	@ 100A, $T_J = 25^\circ\text{C}$	
di/dt Max. Rate of Rise of Turned-on Current	150	A/ μs	$T_J = 25^\circ\text{C}$	
I_H Max. Holding Current	200	mA	$T_J = 25^\circ\text{C}$	
I_L Max. Latching Current	400			
I_{RRM}/I_{DRM} Max. Reverse and Direct Leakage Current	1.0/15	mA	$T_J = 25^\circ\text{C}$	$V_R = \text{rated } V_{RRM}/V_{DRM}$
			$T_J = 125^\circ\text{C}$	
dv/dt Max. Rate of Rise	500		V/ μs	

Triggering

Parameters	70TPS..	Units	Conditions		
P_{GM} Max. peak Gate Power	10	W	$t = 30\mu s$		
$P_{G(AV)}$ Max. average Gate Power	2.5				
I_{GM} Max. peak Gate Current	2.5	A			
$-V_{GM}$ Max. peak negative Gate Voltage	10	V			
V_{GT} Max. required DC Gate Voltage to trigger	4.0		$T_J = -40^\circ C$	Anode supply = 6V resistive load	
	1.5		$T_J = 25^\circ C$		
	1.1		$T_J = 125^\circ C$		
I_{GT} Max. required DC Gate Current to trigger	270	mA	$T_J = -40^\circ C$		
	100		$T_J = 25^\circ C$		
	80		$T_J = 125^\circ C$		
V_{GD} Max. DC Gate Voltage not to trigger	0.25	V	$T_J = 125^\circ C, V_{DRM} = \text{rated value}$		
I_{GD} Max. DC Gate Current not to trigger	6	mA			

Thermal-Mechanical Specifications

Parameters	70TPS..	Units	Conditions	
T_J Max. Junction Temperature Range	-40 to 125	°C		
T_{stg} Max. Storage Temperature Range	-40 to 150			
R_{thJC} Max. Thermal Resistance Junction to Case	0.27	°C/W	DC operation	
	R_{thJA} Max. Thermal Resistance Junction to Ambient		40	
R_{thCS} Max. Thermal Resistance Case to Heatsink	0.2		Mounting surface, smooth and greased	
wt Approximate Weight	6 (0.21)	g (oz.)		
T Mounting Torque	Min. 6 (5)	Kg-cm (lbf-in)		
	Max. 12 (10)			
Case Style	Super-247			

ΔR Conduction (per Junction)

(The following table shows the increment of thermal resistance R_{thJC} when devices operate at different conduction angles than DC)

Device	Sine half wave conduction					Rect. wave conduction					Units
	180°	120°	90°	60°	30°	180°	120°	90°	60°	30°	
70TPS	0.078	0.092	0.117	0.172	0.302	0.053	0.092	0.125	0.180	0.306	°C/W

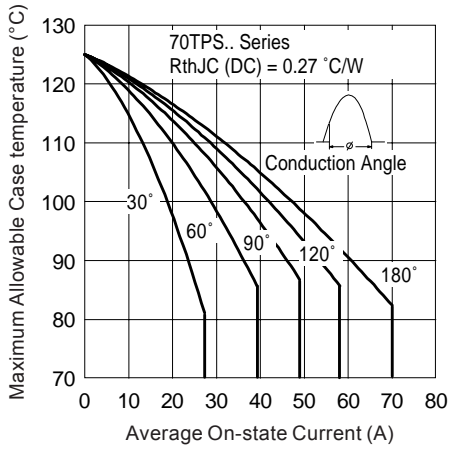

Fig. 1 - Current Rating Characteristics

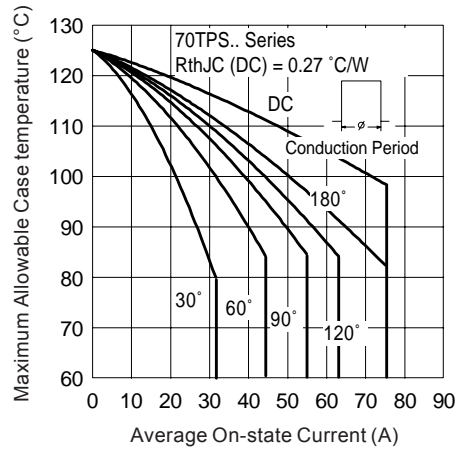

Fig. 2 - Current Rating Characteristics

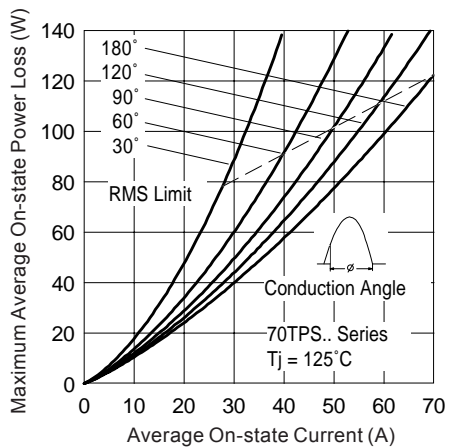

Fig. 3 - On-state Power Loss Characteristics

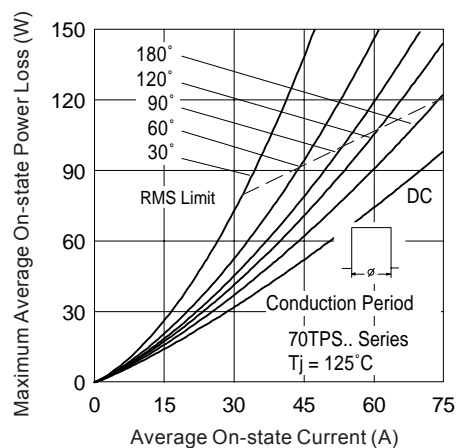

Fig. 4 - On-state Power Loss Characteristics

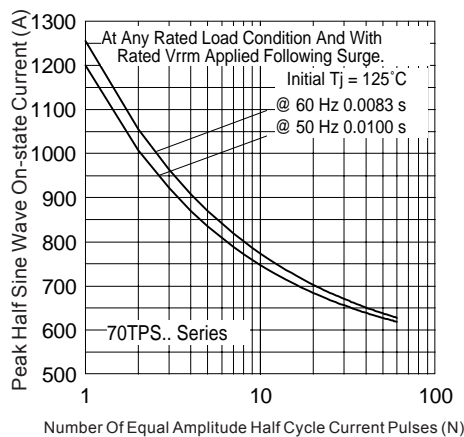

Fig. 5 - Maximum Non-Repetitive Surge Current

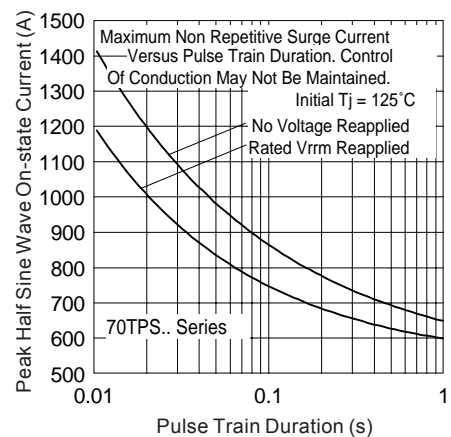

Fig. 6 - Maximum Non-Repetitive Surge Current

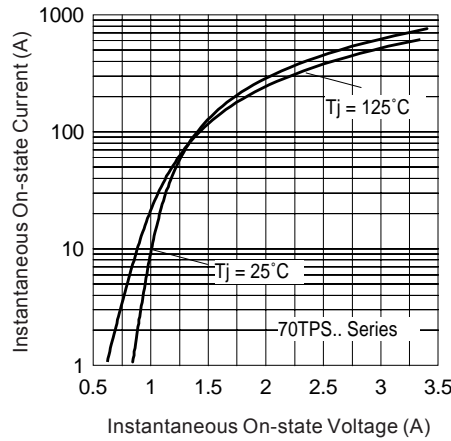

Fig. 7 - On-state Voltage Drop Characteristics

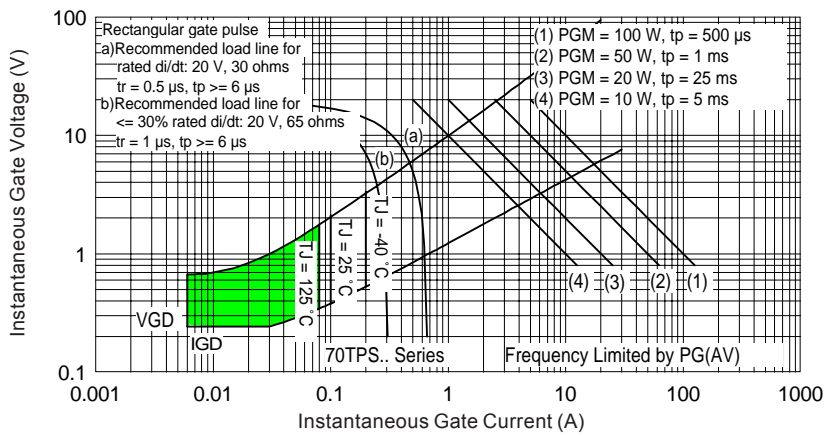

Fig. 8 - Gate Characteristics

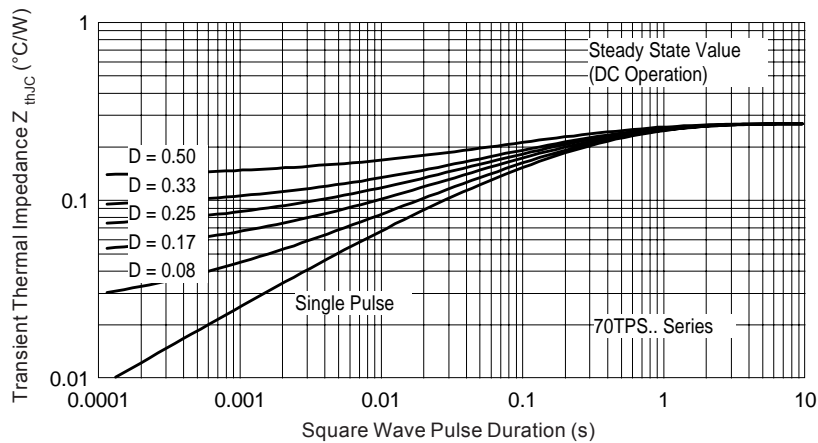
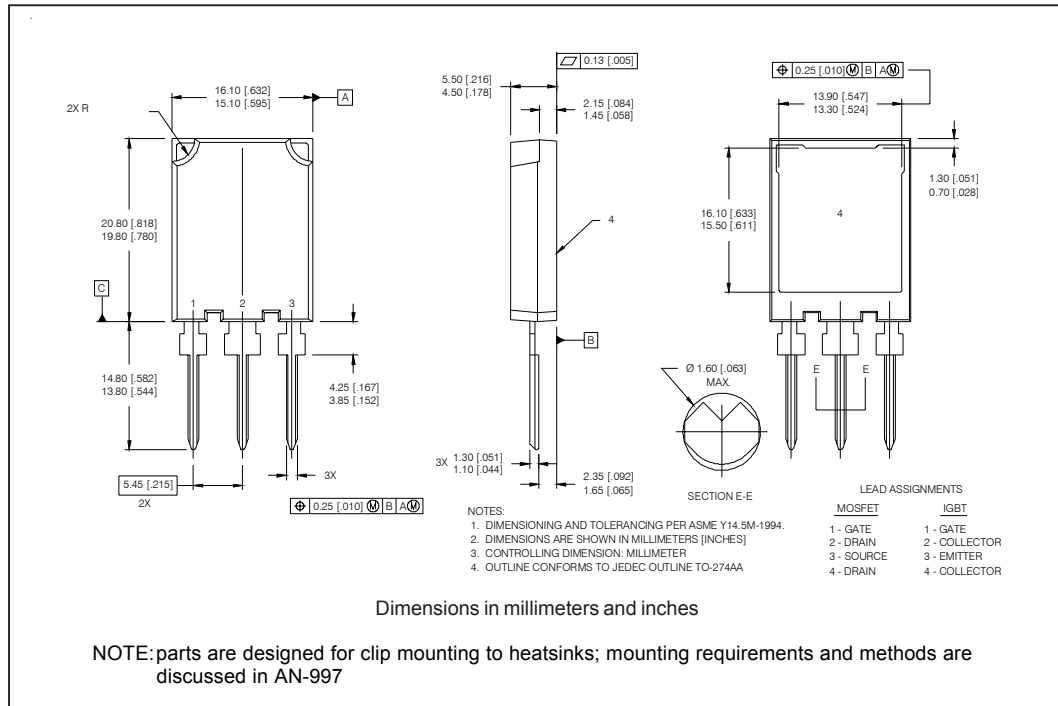
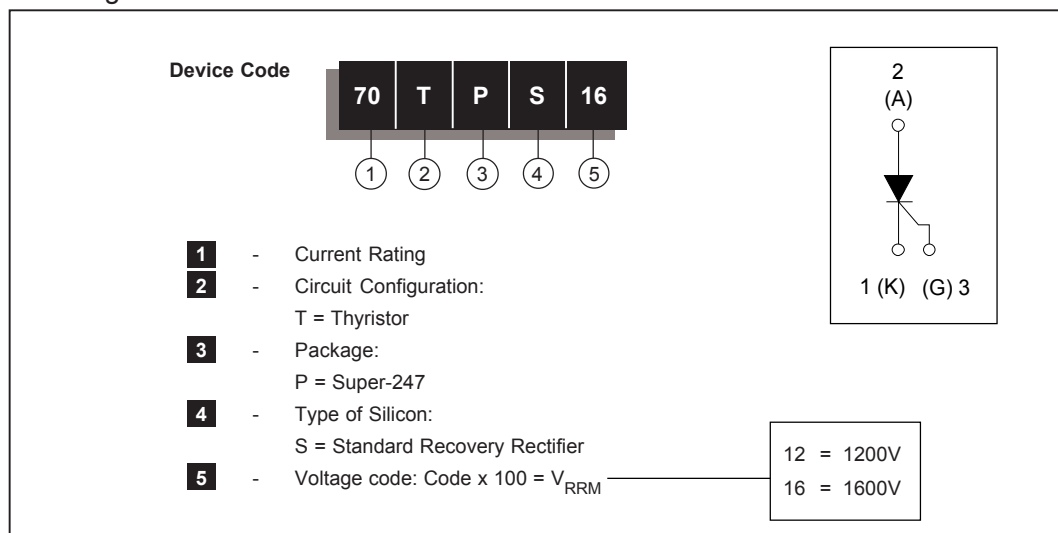

Fig. 9 - Thermal Impedance Z_{thjC} Characteristics

Outline Table



Ordering Information Table



Data and specifications subject to change without notice.
This product has been designed for Industrial Level.
Qualification Standards can be found on IR's Web site.

International
IOR Rectifier

IR WORLD HEADQUARTERS: 233 Kansas St., El Segundo, California 90245, USA Tel: (310) 252-7105
TAC Fax: (310) 252-7309
Visit us at www.irf.com for sales contact information. 10/04