



T1235H Series

SNUBBERLESS™ HIGH TEMPERATURE

12A TRIACs

MAIN FEATURES:

Symbol	Value	Unit
$I_{T(RMS)}$	12	A
V_{DRM}/V_{RRM}	600	V
$I_{GT}(Q_1)$	35	mA

DESCRIPTION

Specifically designed for use in high temperature environment (found in hot appliances such as cookers, ovens, hobs, electric heaters, coffee machines...), the new 12 Amps T1235H triacs provide an enhanced performance in terms of power loss and thermal dissipation. This allows for optimization of the heatsinking dimensioning, leading to space and cost effectiveness when compared to electro-mechanical solutions.

Based on ST snubberless technology, they offer high commutation switching capabilities and high noise immunity levels. And, thanks to their clip assembly technique, they provide a superior performance in surge current handling.

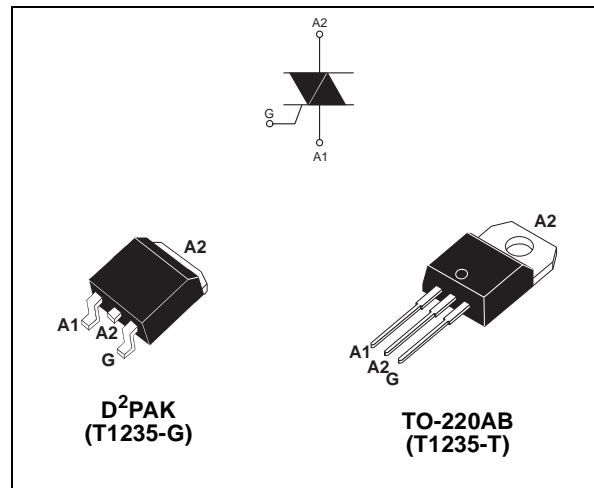

ABSOLUTE MAXIMUM RATINGS

Symbol	Parameter		Value	Unit
$I_{T(RMS)}$	RMS on-state current (full sine wave)		$T_c = 135^\circ\text{C}$ 12	A
I_{TSM}	Non repetitive surge peak on-state current (full cycle, T_j initial = 25°C)	F = 60 Hz t = 16.7 ms	145	A
		F = 50 Hz t = 20 ms	140	
I^2t	I^2t Value for fusing	tp = 10 ms	112	A ² s
di/dt	Critical rate of rise of on-state current $I_G = 2 \times I_{GT}$, tr ≤ 100 ns	F = 120 Hz $T_j = 150^\circ\text{C}$	50	A/μs
V_{DSM}/V_{RSM}	Non repetitive surge peak off-state voltage	tp = 10 ms $T_j = 25^\circ\text{C}$	700	V
I_{GM}	Peak gate current	tp = 20 μs $T_j = 150^\circ\text{C}$	4	A
$P_{G(AV)}$	Average gate power dissipation	$T_j = 150^\circ\text{C}$	1	W
T_{stg} T_j	Storage junction temperature range Operating junction temperature range		- 40 to + 150 - 40 to + 150	°C

T1235H Series

ELECTRICAL CHARACTERISTICS (T_j = 25°C, unless otherwise specified)

Symbol	Test Conditions	Quadrant		Value	Unit
I _{GT} (1)	V _D = 12 V R _L = 33 Ω	I - II - III	MAX.	35	mA
V _{GT}		I - II - III	MAX.	1.3	V
V _{GD}	V _D = V _{DRM} R _L = 3.3 kΩ T _j = 150°C	I - II - III	MIN.	0.15	V
I _H (2)	I _T = 100 mA		MAX.	35	mA
I _L	I _G = 1.2 I _{GT}	I - III	MAX.	50	mA
		II		80	
dV/dt (2)	V _D = 67 % V _{DRM} gate open T _j = 150°C		MIN.	300	V/μs
(dl/dt) _c (2)	Without snubber T _j = 150°C		MIN.	5.3	A/ms

STATIC CHARACTERISTICS

Symbol	Test Conditions		Value	Unit	
V _{TM} (2)	I _{TM} = 17 A t _p = 380 μs	T _j = 25°C	MAX.	1.5	V
V _{to} (2)	Threshold voltage	T _j = 150°C	MAX.	0.80	V
R _d (2)	Dynamic resistance	T _j = 150°C	MAX.	25	mΩ
I _{DRM}	V _{DRM} = V _{RDM}	T _j = 25°C	MAX.	5	μA
		T _j = 150°C		5.5	mA
I _{RDM}	V _D /V _R = 400 V (at mains peak voltage)	T _j = 150°C		3.5	

Note 1: minimum I_{GT} is guaranteed at 10% of I_{GT} max.

Note 2: for both polarities of A2 referenced to A1

THERMAL RESISTANCES

Symbol	Parameter	Value	Unit		
R _{th(j-c)}	Junction to case (AC)	D ² PAK TO-220AB	1.2	°C/W	
R _{th(j-a)}	Junction to ambient	S = 1 cm ²	D ² PAK	45	°C/W
			TO-220AB	60	

S: Copper surface under tab

PRODUCT SELECTOR

Part Number	Voltage	Sensitivity	Type	Package
T1235H-600G	600 V	35 mA	Snubberless	D ² PAK
T1235H-600T	600 V	35 mA	Snubberless	TO-220AB

ORDERING INFORMATION

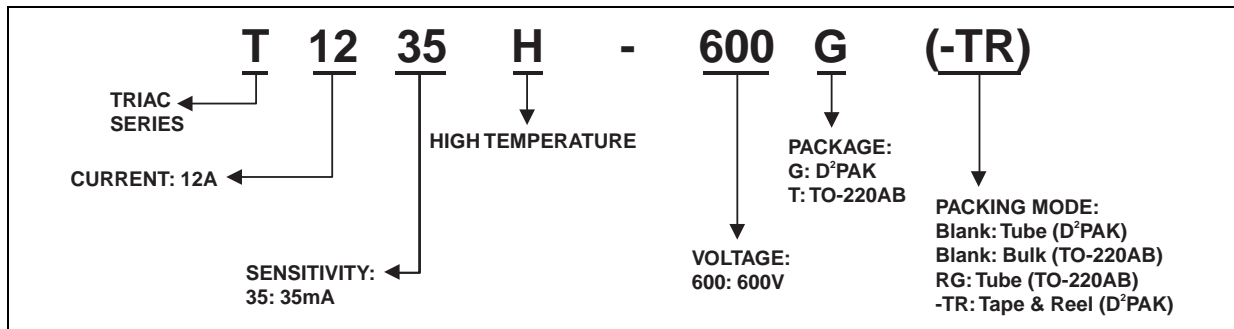

OTHER INFORMATION

Part Number	Marking	Weight	Base quantity	Packing mode
T1235H-600G	T1235H600G	1.5 g	50	Tube
T1235H-600G-TR	T1235H600G	1.5 g	1000	Tape & reel
T1235H-600T	T1235H600T	2.3 g	250	Bulk
T1235H-600TRG	T1235H-600T	2.3 g	50	Tube

Fig. 1: Maximum power dissipation versus RMS on-state current (full cycle).

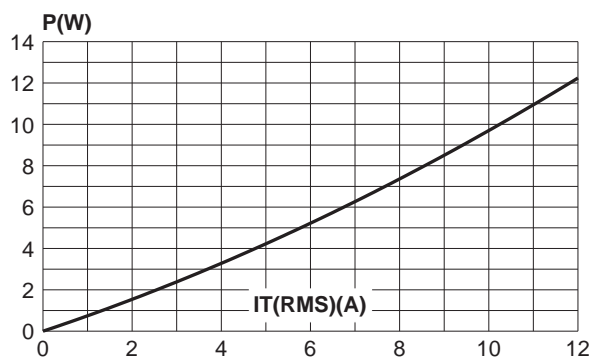

Fig. 2-2: RMS on-state current versus ambient temperature (printed circuit board FR4, copper thickness: 35 μm), full cycle.

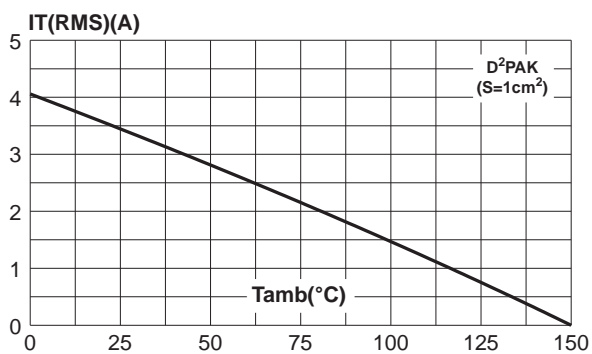

Fig. 2-1: RMS on-state current versus case temperature (full cycle).

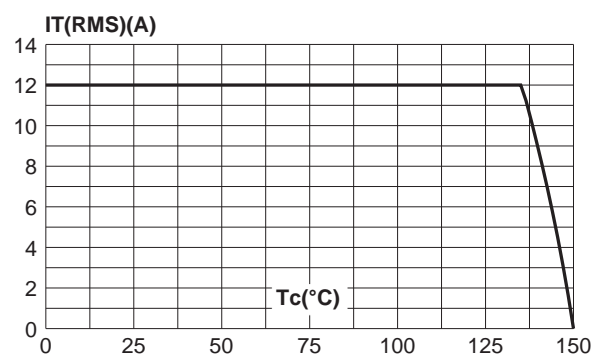

Fig. 3: Relative variation of thermal impedance versus pulse duration.

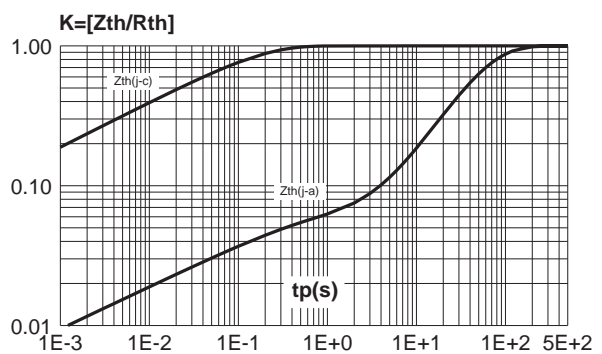

Fig. 4: Relative variation of gate trigger current, holding current and latching current versus junction temperature (typical values).

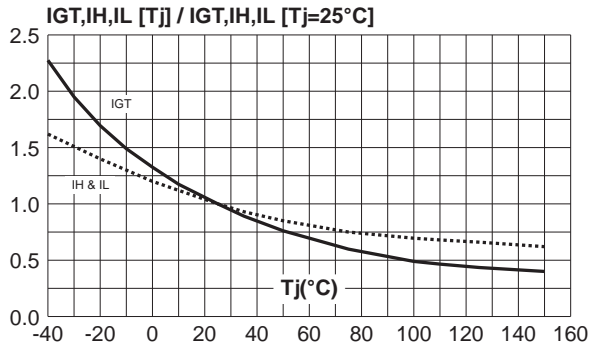

Fig. 6: Non-repetitive surge peak on-state current for a sinusoidal pulse with width $t_p < 10\text{ms}$, and corresponding value of I^2t .

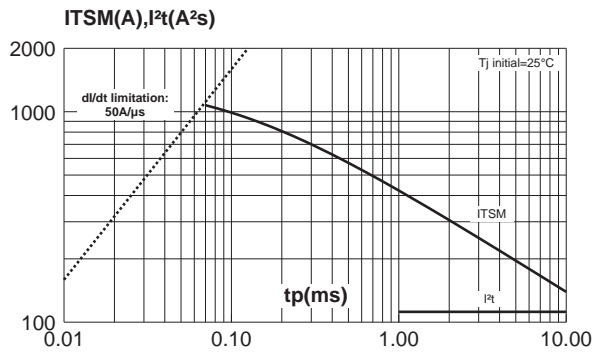

Fig. 8: Relative variation of critical rate of decrease of main current versus junction temperature (typical values).

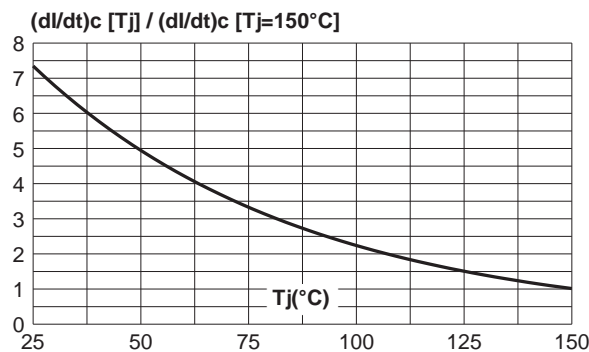

Fig. 5: Surge peak on-state current versus number of cycles.

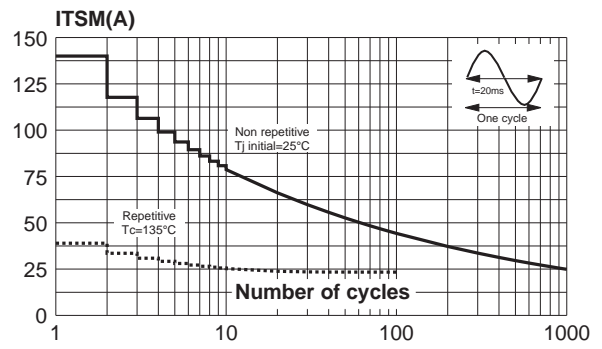

Fig. 7: On-state characteristics (maximum values).

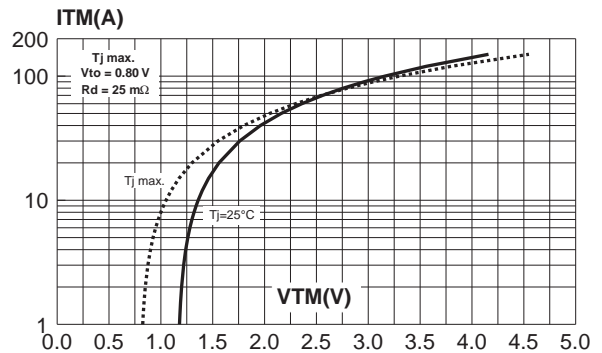

Fig. 9: Relative variation of critical rate of decrease of main current versus $(dV/dt)_c$ (typical values).

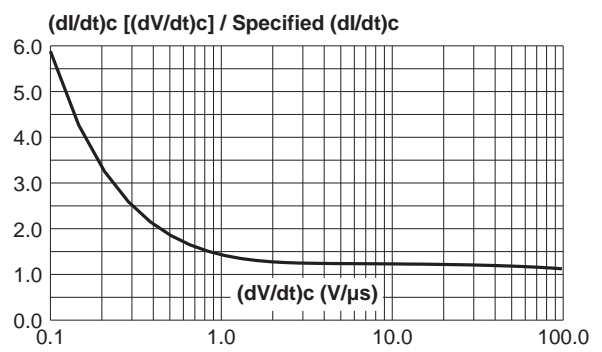

Fig. 10: Leakage current versus junction temperature for different values of blocking voltage (typical values).

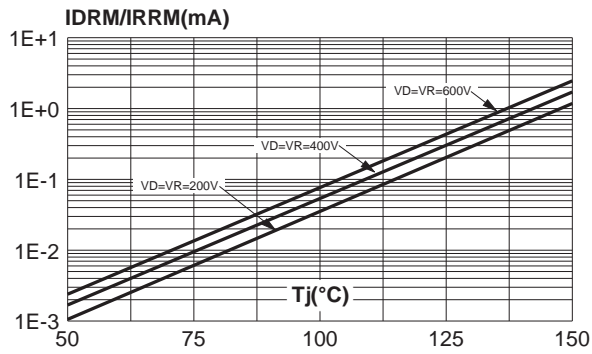

Fig. 11: Acceptable repetitive peak off-state voltage versus case-ambient thermal resistance.

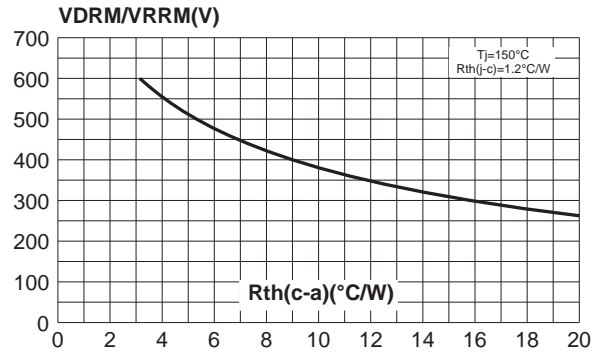
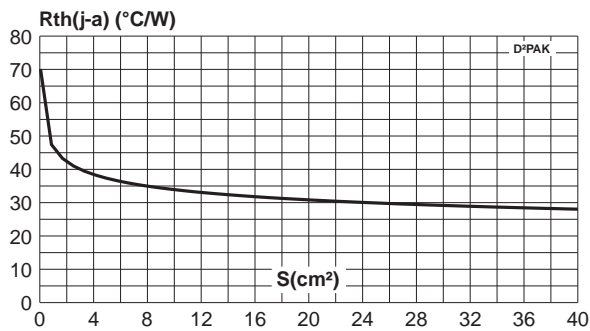
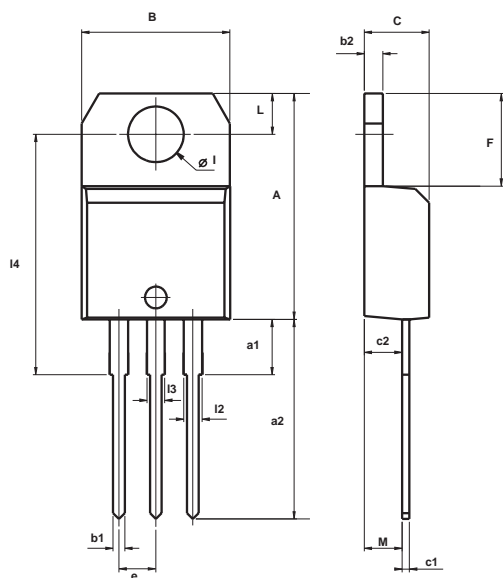

Fig. 12: D²PAK Thermal resistance junction to ambient versus copper surface under tab (printed circuit board FR4, copper thickness: 35 μm).



PACKAGE MECHANICAL DATA

TO-220AB (Plastic)



REF.	DIMENSIONS					
	Millimeters			Inches		
	Min.	Typ.	Max.	Min.	Typ.	Max.
A	15.20		15.90	0.598		0.625
a1		3.75			0.147	
a2	13.00		14.00	0.511		0.551
B	10.00		10.40	0.393		0.409
b1	0.61		0.88	0.024		0.034
b2	1.23		1.32	0.048		0.051
C	4.40		4.60	0.173		0.181
c1	0.49		0.70	0.019		0.027
c2	2.40		2.72	0.094		0.107
e	2.40		2.70	0.094		0.106
F	6.20		6.60	0.244		0.259
I	3.75		3.85	0.147		0.151
I4	15.80	16.40	16.80	0.622	0.646	0.661
L	2.65		2.95	0.104		0.116
I2	1.14		1.70	0.044		0.066
I3	1.14		1.70	0.044		0.066
M		2.60			0.102	

PACKAGE MECHANICAL DATA

D²PAK (Plastic)

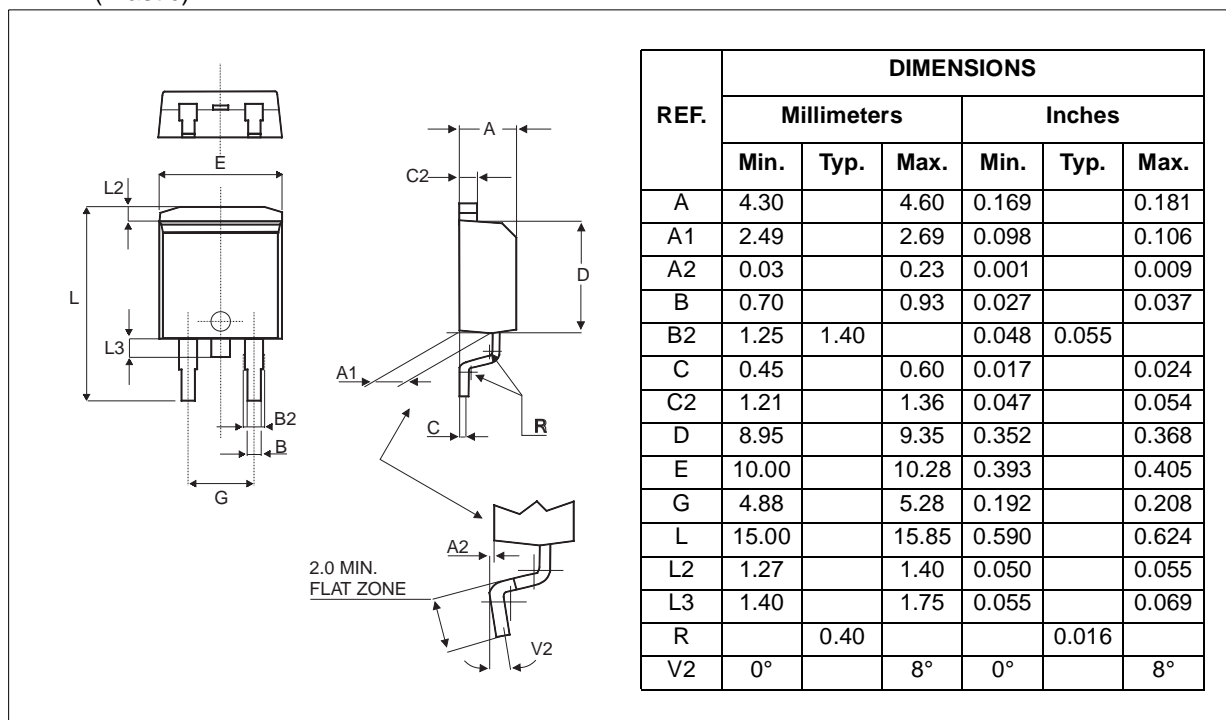

FOOTPRINT DIMENSIONS (in millimeters)

D²PAK (Plastic)

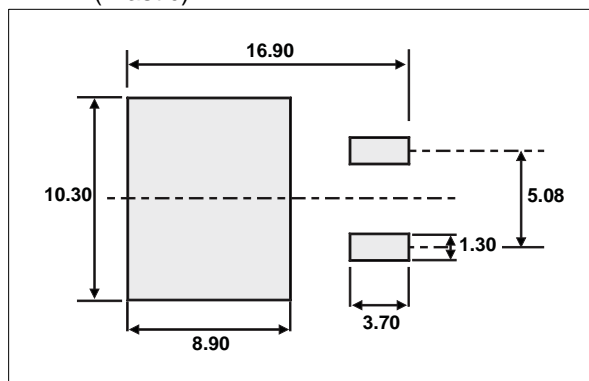

Information furnished is believed to be accurate and reliable. However, STMicroelectronics assumes no responsibility for the consequences of use of such information nor for any infringement of patents or other rights of third parties which may result from its use. No license is granted by implication or otherwise under any patent or patent rights of STMicroelectronics. Specifications mentioned in this publication are subject to change without notice. This publication supersedes and replaces all information previously supplied. STMicroelectronics products are not authorized for use as critical components in life support devices or systems without express written approval of STMicroelectronics.

© The ST logo is a registered trademark of STMicroelectronics

© 2002 STMicroelectronics - Printed in Italy - All Rights Reserved

STMicroelectronics GROUP OF COMPANIES
 Australia - Brazil - Canada - China - Finland - France - Germany
 Hong Kong - India - Israel - Italy - Japan - Malaysia - Malta - Morocco - Singapore
 Spain - Sweden - Switzerland - United Kingdom - United States.

<http://www.st.com>

