

Schnelle GaAlAs-IR-Lumineszenzdiode High-Speed GaAlAs Infrared Emitter

SFH 4590
SFH 4595

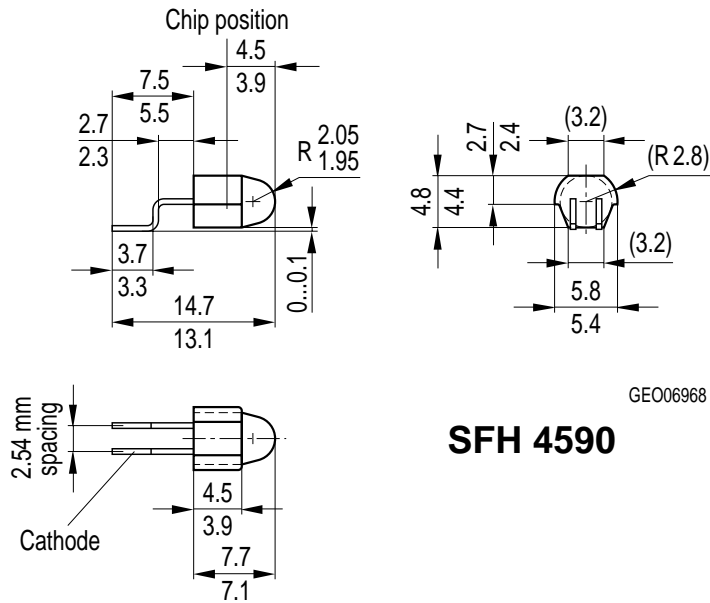

SFH 4590

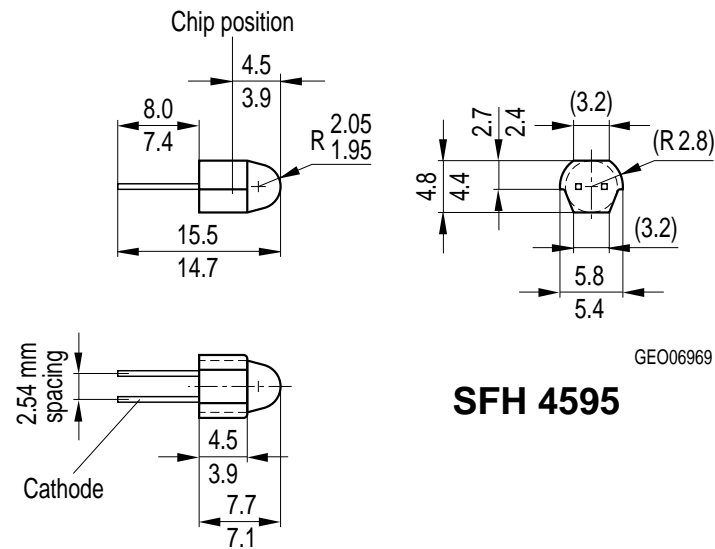

SFH 4595

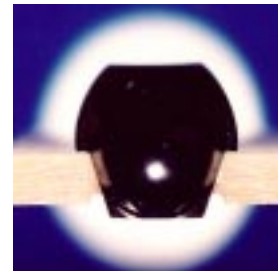

Maße in mm, wenn nicht anders angegeben/Dimensions in mm, unless otherwise specified.

Wesentliche Merkmale

- Hohe Pulsleistung sowie hoher Gesamtstrahlungsfluß Φ_e
- Sehr kurze Schaltzeiten (10 ns)
- Geringe Vorwärtsspannung und Leistungsaufnahme
- Sehr hohe Langzeitstabilität
- Hohe Zuverlässigkeit
- Gegurtet lieferbar
- Geeignet für Oberflächenmontage (SMT)
- Gleiches Gehäuse wie Photodiode SFH 2500/ SFH 2505 und Phototransistor SFH 3500/ SFH 3505
- Spektrale Anpassung an Si-Photodetektoren

Anwendungen

- Schnelle Datenübertragung mit Übertragungsraten bis zu 100 Mbaud (IR Tastatur, Joystick, Multimedia)
- Analoge und digitale Hi-Fi Audio- und Video-signalübertragung
- Batteriebetriebene Geräte (geringe Stromaufnahme)
- Anwendungen mit hohen Zuverlässigkeitsansprüchen bzw. erhöhten Ansprüchen
- Alarm- und Sicherungssysteme
- IR Freiraumübertragung

Features

- High pulse power and high radiant flux Φ_e
- Very short switching times (10 ns)
- Low forward voltage and power dissipation
- Very high long-time stability
- High reliability
- Available on tape and reel
- Suitable for surface mounting (SMT)
- Same package as photodiode SFH 2500/ SFH 2505 and phototransistor SFH 3500/ SFH 3505
- Spectral match with silicon photodetectors

Applications

- High data transmission rate up to 100 Mbaud (IR keyboard, Joystick, Multimedia)
- Analog and digital Hi-Fi audio and video signal transmission
- Low power consumption (battery) equipment
- Suitable for professional and high-reliability applications
- Alarm and safety equipment
- IR free air transmission

Typ Type	Bestellnummer Ordering Code	Gehäuse Package
SFH 4590 SFH 4595	on request on request	5 mm-LED-Gehäuse (T1 ³ / ₄), klar, Anschlüsse im 2,54-mm Raster, Anodenkennzeichnung: kurzer Anschluß 5-mm-LED package (T1 ³ / ₄), clear, solder tabs 2.54-mm (¹ / ₁₀ "), anode marking: short lead

Grenzwerte ($T_A = 25\text{ °C}$)
Maximum Ratings

Bezeichnung Description	Symbol Symbol	Wert Value	Einheit Unit
Betriebs- und Lagertemperatur Operating and storage temperature range	$T_{op}; T_{stg}$	- 40 ... + 100	°C
Sperrspannung Reverse voltage	V_R	3	V
Durchlaßstrom Forward current	I_F (DC)	100	mA
Stoßstrom, $t_p = 10\text{ }\mu\text{s}$, $D = 0$ Surge current	I_{FSM}	2	A
Verlustleistung Power dissipation	P_{tot}	200	mW
Wärmewiderstand Sperrschicht - Umgebung, freie Beinchenlänge max. 10 mm Thermal resistance junction - ambient, lead length between package bottom and PCB max. 10 mm	R_{thJA}	375	K/W

Kennwerte ($T_A = 25\text{ °C}$)

Characteristics

Bezeichnung Description	Symbol Symbol	Wert Value	Einheit Unit
Wellenlänge der Strahlung Wavelength of peak emission $I_F = 100\text{ mA}$, $t_p = 20\text{ ms}$	λ_{peak}	880	nm
Spektrale Bandbreite bei 50% von I_{max} Spectral bandwidth at 50% of I_{max} $I_F = 100\text{ mA}$, $t_p = 20\text{ ms}$	$\Delta\lambda$	25	nm
Abstrahlwinkel Half angle	φ	± 14	Grad deg.
Aktive Chipfläche Active chip area	A	0.09	mm ²
Abmessungen der aktiven Chipfläche Dimension of the active chip area	$L \times B$ $L \times W$	0.3×0.3	mm
Schaltzeiten, I_e von 10% auf 90% und von 90% auf 10%, bei $I_F = 100\text{ mA}$, $t_p = 20\text{ ms}$, $R_L = 50\ \Omega$ Switching times, I_e from 10% to 90% and from 90% to 10%, $I_F = 100\text{ mA}$, $t_p = 20\text{ ms}$, $R_L = 50\ \Omega$	t_r , t_f	10	ns
Kapazität Capacitance $V_R = 0\text{ V}$, $f = 1\text{ MHz}$	C_o	35	pF
Durchlaßspannung Forward voltage $I_F = 100\text{ mA}$, $t_p = 20\text{ ms}$ $I_F = 1\text{ A}$, $t_p = 100\ \mu\text{s}$	V_F V_F	1.5 (≤ 2.0) 3.0 (≤ 3.8)	V V
Sperrstrom Reverse current $V_R = 3\text{ V}$	I_R	0.01 (≤ 10)	μA
Gesamtstrahlungsfluß Total radiant flux $I_F = 100\text{ mA}$, $t_p = 20\text{ ms}$	Φ_e	25	mW
Temperaturkoeffizient von I_e bzw. Φ_e , $I_F = 100\text{ mA}$ Temperature coefficient of I_e or Φ_e , $I_F = 100\text{ mA}$	TC_1	-0.44	%/K

Kennwerte ($T_A = 25\text{ °C}$)
Characteristics (cont'd)

Bezeichnung Description	Symbol Symbol	Wert Value	Einheit Unit
Temperaturkoeffizient von V_F , $I_F = 100\text{ mA}$ Temperature coefficient of V_F , $I_F = 100\text{ mA}$	TC_V	- 2	mV/K
Temperaturkoeffizient von λ , $I_F = 100\text{ mA}$ Temperature coefficient of λ , $I_F = 100\text{ mA}$	TC_λ	+ 0.13	nm/K

Strahlstärke I_e in Achsrichtung

gemessen bei einem Raumwinkel $\Omega = 0.01\text{ sr}$

Radiant intensity I_e in axial direction

at a solid angle of $\Omega = 0.01\text{ sr}$

Bezeichnung Description	Symbol	Werte Values	Einheit Unit
Strahlstärke Radiant intensity $I_F = 100\text{ mA}$, $t_p = 20\text{ ms}$	$I_{e\text{ min}}$ $I_{e\text{ typ}}$	25 60	mW/sr
Strahlstärke Radiant intensity $I_F = 1\text{ A}$, $t_p = 100\text{ }\mu\text{s}$	$I_{e\text{ typ}}$	350	mW/sr

Lötbedingungen
Soldering Conditions

Tauch-, Schwall- und Schleplötung Dip, wave and drag soldering			Kolbenlötung (mit 1,5-mm-Kolbenspitze) Iron soldering (with 1.5-mm-bit)		
Lötbad- temperatur	Maximal zulässige Lötzeit	Abstand Lötstelle – Gehäuse	Temperatur des Kolbens	Maximale zulässige Lötzeit	Abstand Lötstelle – Gehäuse
Temperature of the soldering bath	Max. perm. soldering time	Distance between solder joint and case	Temperature of the solder- ing iron	Max. permissi- ble soldering time	Distance between solder joint and case
260 °C	10 s	$\geq 1.5\text{ mm}$	300 °C	3 s	$\geq 1.5\text{ mm}$

Relative spectral emission

$$I_{rel} = f(\lambda)$$

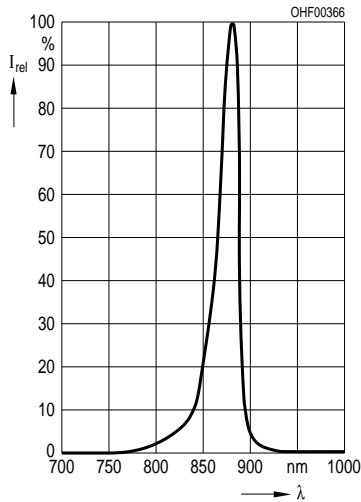

Radiant intensity $\frac{I_e}{I_e 100 \text{ mA}} = f(I_F)$

Single pulse, $t_p = 20 \mu\text{s}$

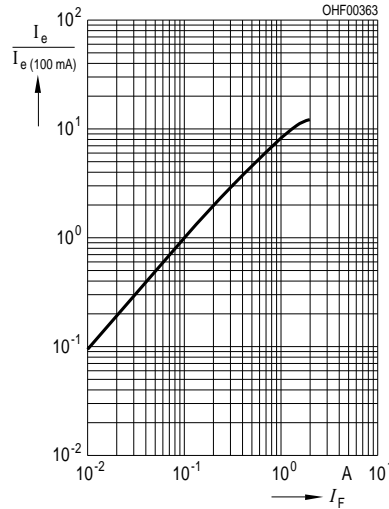

Max. permissible forward current

$$I_F = f(T_A)$$

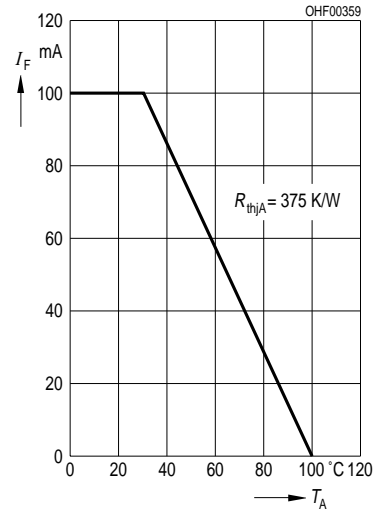

Forward current $I_F = f(V_F)$

single pulse, $t_p = 20 \mu\text{s}$

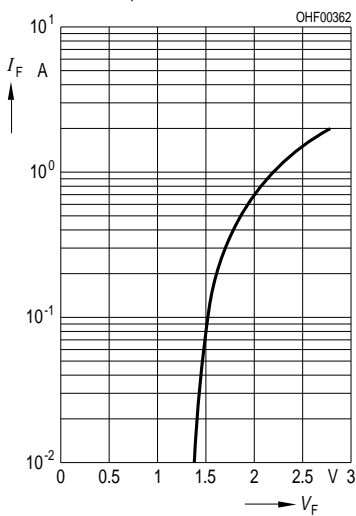

Radiation characteristics $I_{rel} = f(\varphi)$

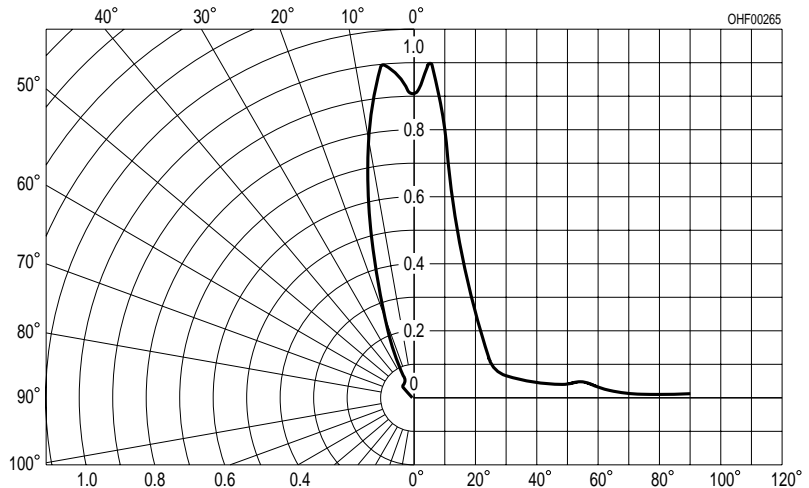

Permissible pulse power

Duty cycle $D = \text{parameter}$, $T_A = 25 \text{ }^\circ\text{C}$

