



AKD4382

Evaluation board Rev.A for AK4382

GENERAL DESCRIPTION

The AKD4382 is an evaluation board for the AK4382, the 24bit, 192kHz D/A converter for DVD and AC-3 amp. The AKD4382 has the interface with AKM's wave generator using ROM data and with AKM's A/D converter evaluation boards. Therefore, it is easy to evaluate the AK4382. The AKD4382 also has the digital audio interface and can achieve the interface with digital audio systems via opt-connector or BNC connector.

■ Ordering guide

AKD4382 --- Evaluation board for AK4382
 (Cable for connecting with printer port of IBM-AT compatible PC and control software are packed with this.)

FUNCTION

- On-board 2nd order LPF
- Compatible with 2 types of interface
 - Direct interface with AKM's A/D converter evaluation boards and direct interface with AKM's signal generator(AKD43XX) by 10pin header
 - On-board AK4112A as DIR which accepts optical or BNC input
- 10pin header for serial control interface

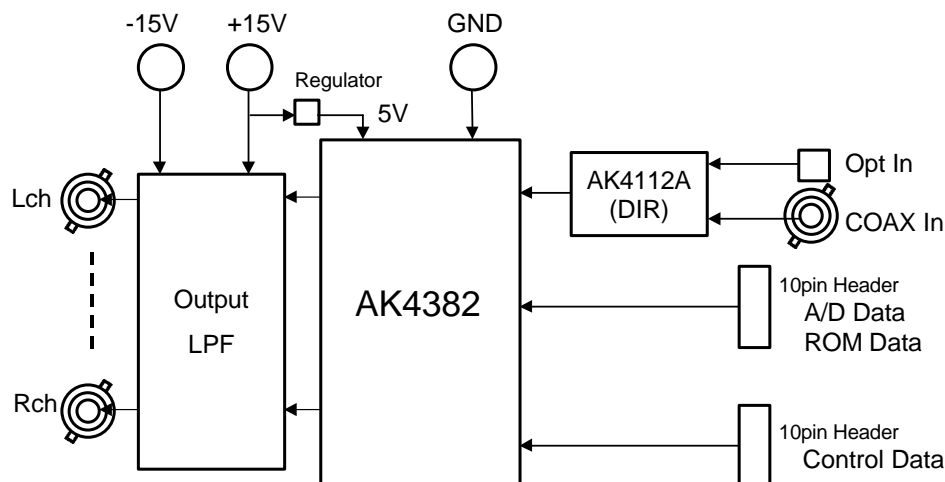

Figure 1. AKD4382 Block Diagram

* Circuit diagram and PCB layout are attached at the end of this manual.

■ External analog circuit

The 2nd order LPF (fc=93.2kHz, Q=0.712) which adds differential outputs of the AK4382 is implemented on the board. When the further attenuation of the out-band noise is needed, some additional LPF is required. Analog signal is output through BNC connectors on the board. And the output level of the AK4382 is 5.5Vpp@5V.

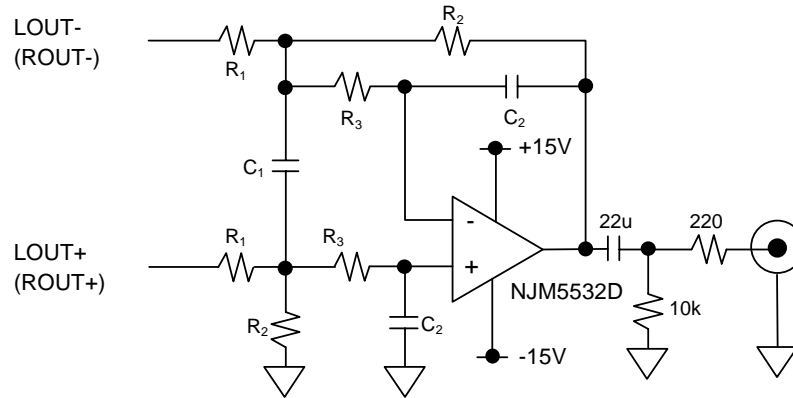

Figure 2. On-board analog filter

R ₁	R ₂	R ₃	C ₁	C ₂
4.7k	4.7k	200	3300p	470p

Table 1. The value of R,C on this board

f _{in}	20kHz	40kHz	80kHz
Frequency Response	-0.003dB	-0.122dB	-1.821dB

Table 2. Frequency Response of LPF

<Calculation>

$$\text{Amplitude} = 20 \log \frac{K}{\sqrt{[1-(f/f_c)^2]^2 + [(1/Q)(f/f_c)]^2}} \text{ [dB]},$$

$$K = \frac{R_2}{R_1},$$

$$f_c = \frac{\omega_0}{2\pi},$$

$$\omega_0 = \frac{1}{\sqrt{2C_1 C_2 R_2 R_3}},$$

$$Q = \frac{2C_1 \omega_0}{\frac{1}{R_1} + \frac{1}{R_2} + \frac{1}{R_3}}.$$

■ Operation sequence

1) Set up the power supply lines.

[+15V]	(orange)	= +12 ~ +15V
[-15V]	(blue)	= -12 ~ -15V
[4382_VDD]	(red)	= 4.75 ~ 5.25V (Note 2)
[AGND]	(black)	= 0V
[DGND]	(black)	= 0V

Note: 1. Each supply line should be distributed from the power supply unit.
 2. JP3(REG) should be shorted and “4382_VDD” jack should be open if VDD of the AK4382 is supplied from the regulator.

2) Set-up the evaluation modes, jumper pins and DIP switches (See the followings.)

3) Power on.

The AK4382 should be reset once bringing SW1(PDN) “L” upon power-up.

■ Evaluation mode

Applicable evaluation modes

- 1) DIR (Optical Link or BNC) (default)
- 2) Using ROM data (AK43XX)
- 3) Using AKM's evaluation board for ADC
- 4) Feeding all signals from external

1) DIR (Optical Link or BNC) <default>

The AK4112A(DIR) generates MCLK, BICK, LRCK and SDATA from the received data through PORT1(TORX176: optical link) or J1(BNC). Used for the evaluation using CD test disk. Nothing should be connected to PORT2(EXT). In case of using optical connector (TORX176), JP1(TORX/BNC) should be selected to “TORX”. In case of using BNC connector, select “BNC”.



2) Ideal sine wave generated by ROM data

Connect the AKD43XX with PORT2(EXT). The AKD4382 sends MCLK to the AKD43XX which the AK4112A(DIR) generates from the received data through PORT1(TORX176: optical link) or J1(BNC). And the AKD4382 receives LRCK, BICK and SDATA from the AKD43XX.

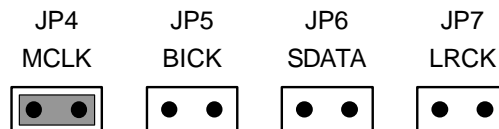

3) Using AKM's evaluation board for ADC

To evaluate the AK4382 with analog input, the AKM's evaluation board for ADC can be used. MCLK, BICK and LRCK and A/D converted data are sent to the AKD4382 through PORT2(EXT) via 10 pin flat cable.

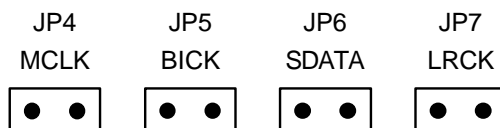

4) Feeding all signals from external

Under the following set-up, all external signals can be fed through POTR2(EXT).

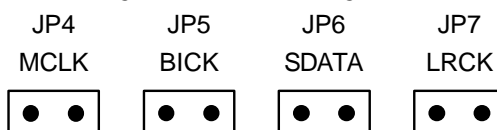

■ DIP switch(S1) set up

S1 sets the mode of the AK4112A. Set-up is needed only for the evaluation mode 1 and 2. ON is "H" and OFF is "L".

No.	Pin	Default	Introduction
1	CM0	OFF	Clock mode set-up (Refer to the table 4.)
2	CM1	OFF	
3	OCKS1	OFF	MCLK frequency set-up (Refer to the table 5.)
4	OCKS0	OFF	

Table 3. S1 set-up

CM1 (S1-2)	CM0 (S1-1)	MCKO	SDTO
OFF	OFF	TORX or BNC	TORX or BNC
OFF	ON	X'tal	"0" data

Table 4. AK4112A clock mode set-up

OCKS1 (S1-3)	OCKS0 (S1-4)	MCLK	LRCK	
			Normal	Double
OFF	OFF	256fs	Yes	Yes
ON	OFF	512fs	Yes	No

Table 5. AK4112A MCLK frequency set-up

■ Jumpers set up

[JP1](TORX/BNC): The source of the biphasic signal input to the AK4112A
 TORX: PORT1(TORX176: optical link) <default>
 BNC: J1(BNC)

[JP2](GND): AGND and DGND
 Open: AGND and DGND are disconnected. <default>
 Short: AGND and DGND are connected. (“DGND” jack can be open.)

[JP3](REG): VDD of the AK4382
 Short: VDD is supplied from the regulator (“4382_VDD” jack should be open). <default>
 Open: VDD is supplied from “4382_VDD” jack.

[JP4](MCLK): MCLK of the AK4382
 Short: MCLK is fed from the AK4112A. <default>
 Open : MCLK is fed from the external circuit via PORT2(EXT).

[JP5](BICK): BICK of the AK4382
 Short: BICK is fed from the AK4112A. <default>
 Open : BICK is fed from the external circuit via PORT2(EXT).

[JP6](SDATA): SDTI of the AK4382
 Short: SDATA is fed from the AK4112A. <default>
 Open : SDATA is fed from the external circuit via PORT2(EXT).

[JP7](LRCK): LRCK of the AK4382
 Short: LRCK is fed from the AK4112A. <default>
 Open : LRCK is fed from the external circuit via PORT2(EXT).

■ The function of the toggle SW

[SW1] (PDN): Resets the AK4382 and the AK4112A. Keep “H” during normal operation.

■ The indication content for LED

[LE1] (ERF) : Unlock and parity error output of the AK4112A.
 [LE2] (FS96) : 96kHz sampling detect of the AK4112A.
 [LE3] (AUTO) : Non-PCM data (AC-3, MPEG etc.) detects of the AK4112A.
 [LE4] (V) : Validity detect of the AK4112A.

■ Serial control

The AKD4382 can be controlled via the printer port (parallel port) of IBM-AT compatible PC. Connect PORT3(uP-I/F) with PC by 10-wire flat cable packed with the AKD4382.

Take care of the direction of connector. There is a mark at 1pin.
 The pin layout of PORT3 is as Figure 4.

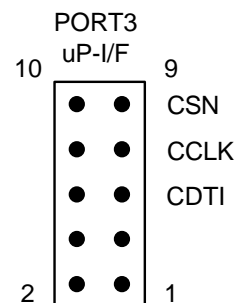

Figure 4. PORT3 pin layout

MEASUREMENT RESULTS

[Measurement condition]

- Measurement unit : Audio Precision System two Cascade
- MCLK : 256fs
- BICK : 64fs
- fs : 44.1kHz, 96kHz
- BW : 10Hz~20kHz (fs=44.1kHz), 10Hz~40kHz (fs=96kHz)
- Bit : 24bit
- Power Supply : VDD=5V
- Interface : DIR
- Temperature : Room

fs=44.1kHz

Parameter	Input signal	Measurement filter	Lch	Rch
S/(N+D)	1kHz, 0dB	20kLPF	95.0dB	95.0dB
DR	1kHz, -60dB	20kLPF	108.0dB	108.0dB
		22kLPF, A-weighted	111.0dB	111.0dB
S/N	no signal	20kLPF	107.1dB	107.1dB
		22kLPF, A-weighted	110.4dB	110.4dB

fs=96kHz

Parameter	Input signal	Measurement filter	Lch	Rch
S/(N+D)	1kHz, 0dB	40kLPF	93.0dB	93.0dB
DR	1kHz, -60dB	40kLPF	105.6dB	105.6dB
		22kLPF, A-weighted	111.8dB	111.7dB
S/N	no signal	40kLPF	105.9dB	105.9dB
		22kLPF, A-weighted	112.2dB	112.0dB

■ Plots

[Measurement condition]

- Measurement unit : Audio Precision System two Cascade
- MCLK : 256fs
- BICK : 64fs
- fs : 44.1kHz, 96kHz
- BW : 10Hz~20kHz (fs=44.1kHz), 10Hz~40kHz (fs=96kHz)
- Bit : 24bit
- Power Supply : VDD=5V
- Interface : DIR
- Temperature : Room

fs=44.1kHz

- Figure 6 . FFT (1kHz, 0dBFS input)
- Figure 7 . FFT (1kHz, -60dBFS input)
- Figure 8 . FFT (noise floor)
- Figure 9 . FFT (out-of-band noise)
- Figure 10. THD+N vs Input Level (fin=1kHz)
- Figure 11. THD+N vs fin (Input level=0dBFS)
- Figure 12. Linearity (fin=1kHz)
- Figure 13. Frequency Response (Input level=0dBFS)
- Figure 14. Cross-talk (Input level=0dBFS)

fs=96kHz

- Figure 15. FFT (1kHz, 0dBFS input, Notch=OFF)
- Figure 16. FFT (1kHz, 0dBFS input, Notch=ON)
- Figure 17. FFT (1kHz, -60dBFS input)
- Figure 18. FFT (noise floor)
- Figure 19. FFT (outband noise)
- Figure 20. THD+N vs Input Level (fin=1kHz)
- Figure 21. THD+N vs fin (Input level=0dBFS)
- Figure 22. Linearity (fin=1kHz)
- Figure 23. Frequency Response (Input level=0dBFS)
- Figure 24. Cross-talk (Input level=0dBFS)

FFT point=16384, Avg=8, Window=Equiripple

(fs=44.1kHz)

AKM

AK4382 FFT (fs=44.1kHz; Input=1kHz, 0dBFS)
FFT points=16384, Avg=8, Window=Equiripple

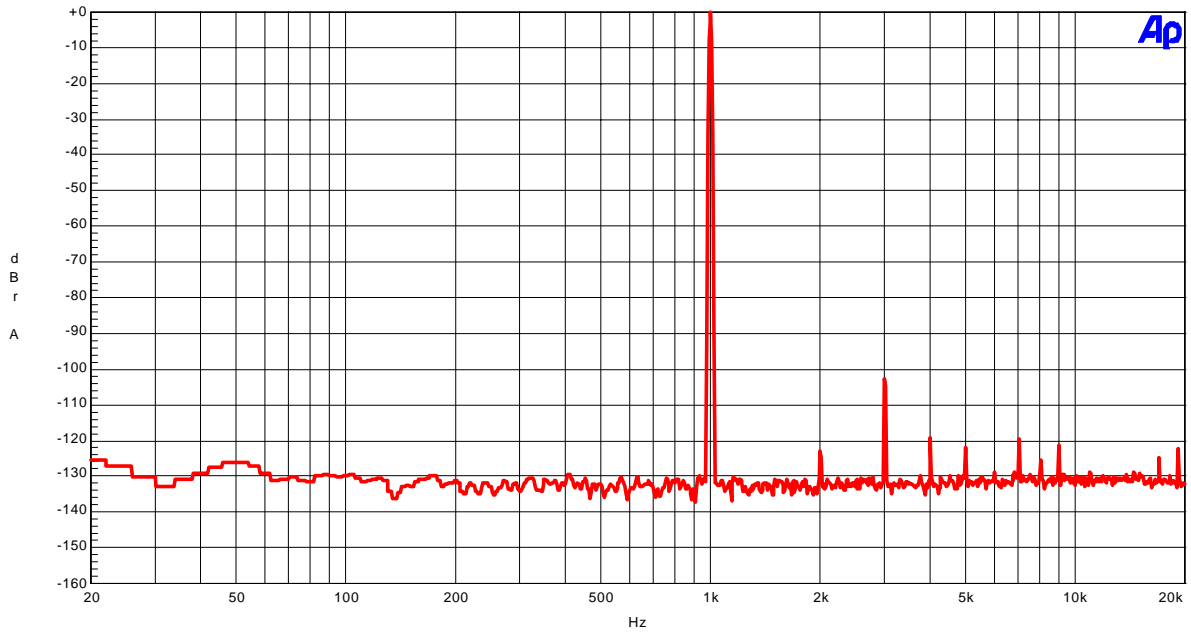

Figure 6 . FFT (1kHz, 0dBFS input)

AKM

AK4382 FFT (fs=44.1kHz; Input=1kHz, -60dBFS)
FFT points=16384, Avg=8, Window=Equiripple

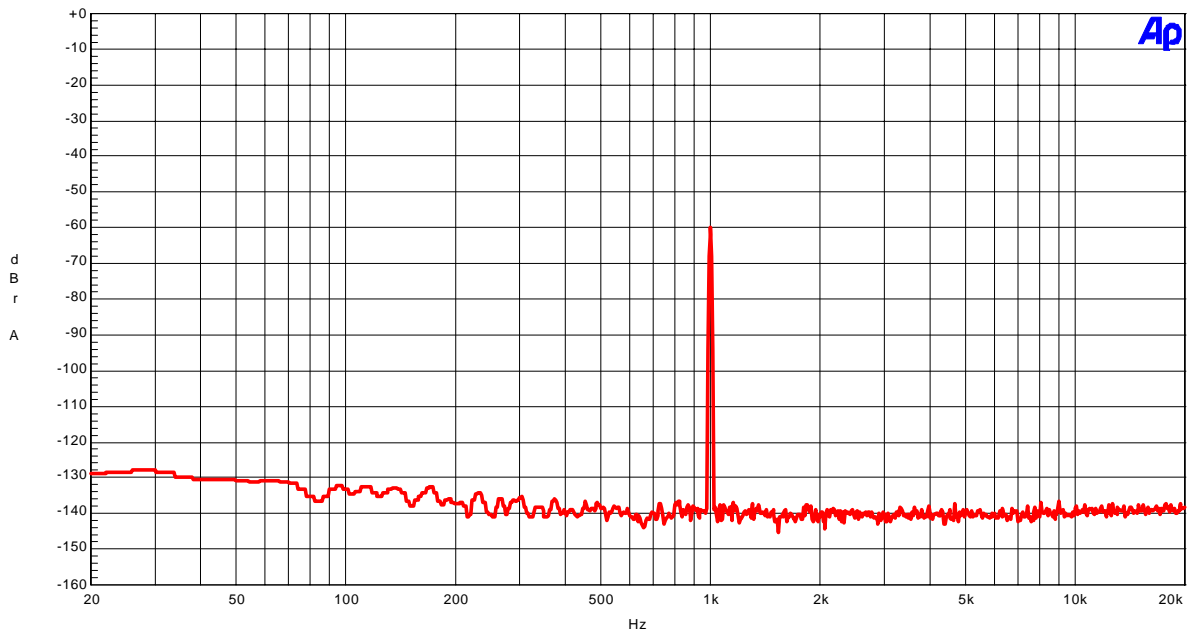

Figure 7 . FFT (1kHz, -60dBFS input)

(fs=44.1kHz)

AKM

AK4382 FFT (fs=44.1kHz; Noise floor)
FFT points=16384, Avg=8, Window=Equiripple

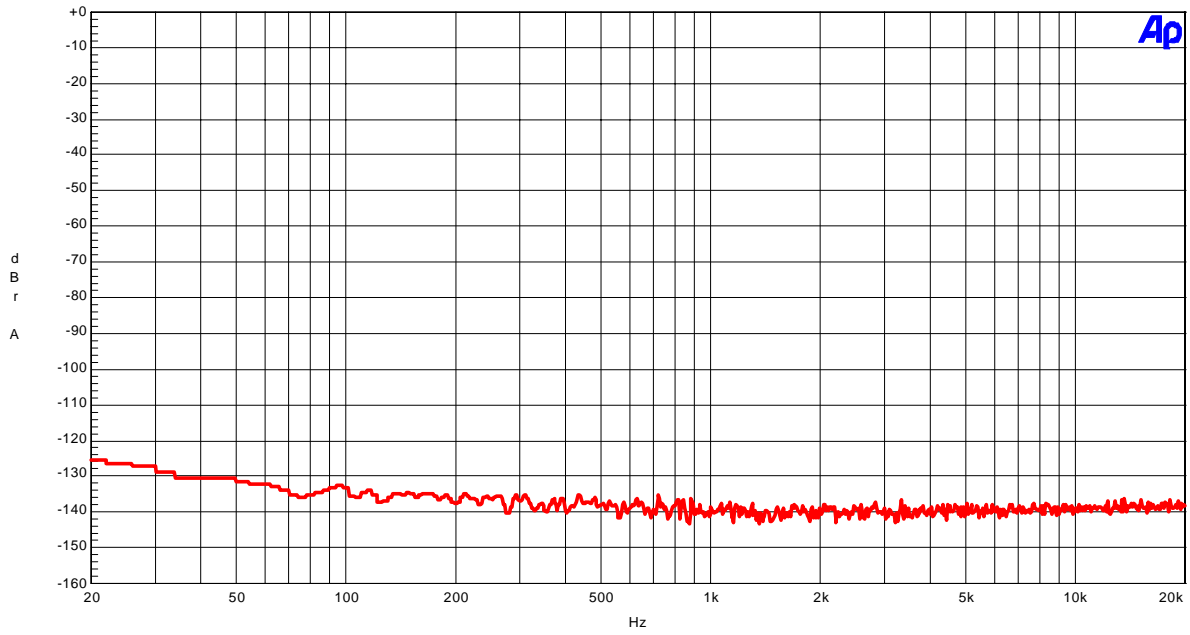

Figure 8 . FFT (noise floor)

AKM

AK4382 FFT (fs=44.1kHz; Out-of-band noise ~130kHz)
FFT points=16384, Avg=8, Window=Equiripple

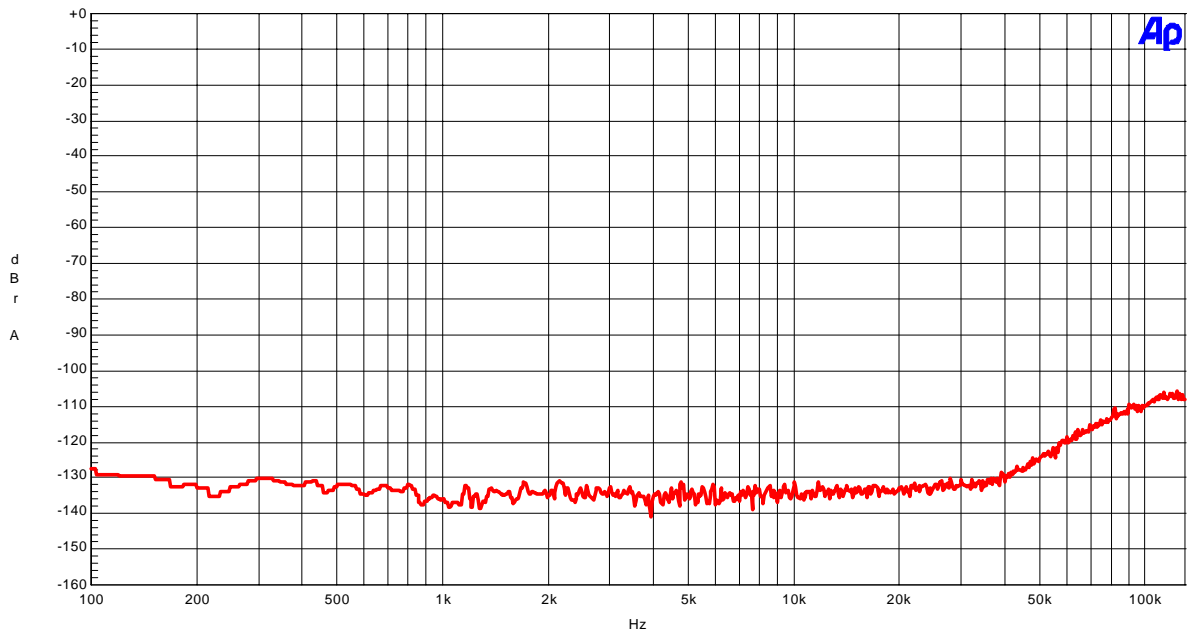

Figure 9 . FFT (out-of-band noise)

(fs=44.1kHz)

AKM

AK4382 THD+N vs Input level (fs=44.1kHz; fin=1kHz)

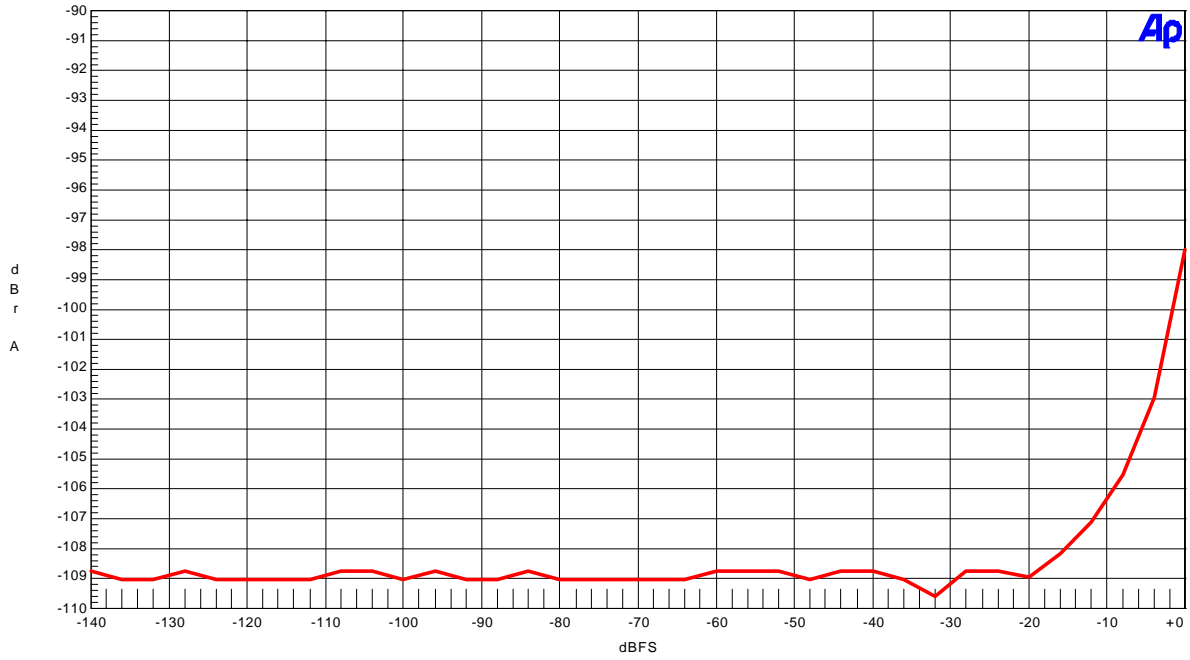

Figure 10. THD+N vs Input Level (fin=1kHz)

AKM

AK4382 THD+N vs fin (fs=44.1kHz; Input level=0dBFS)

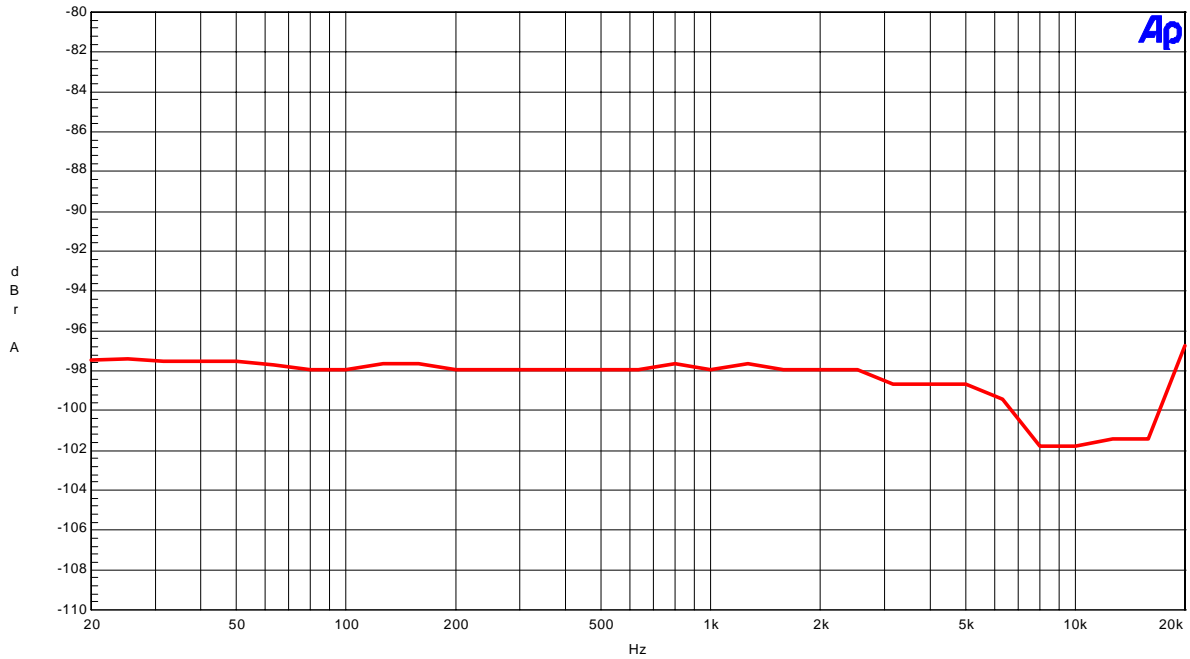

Figure 11. THD+N vs fin (Input level=0dBFS)

(fs=44.1kHz)

AKM

AK4382 Linearity (fs=44.1kHz; fin=1kHz)

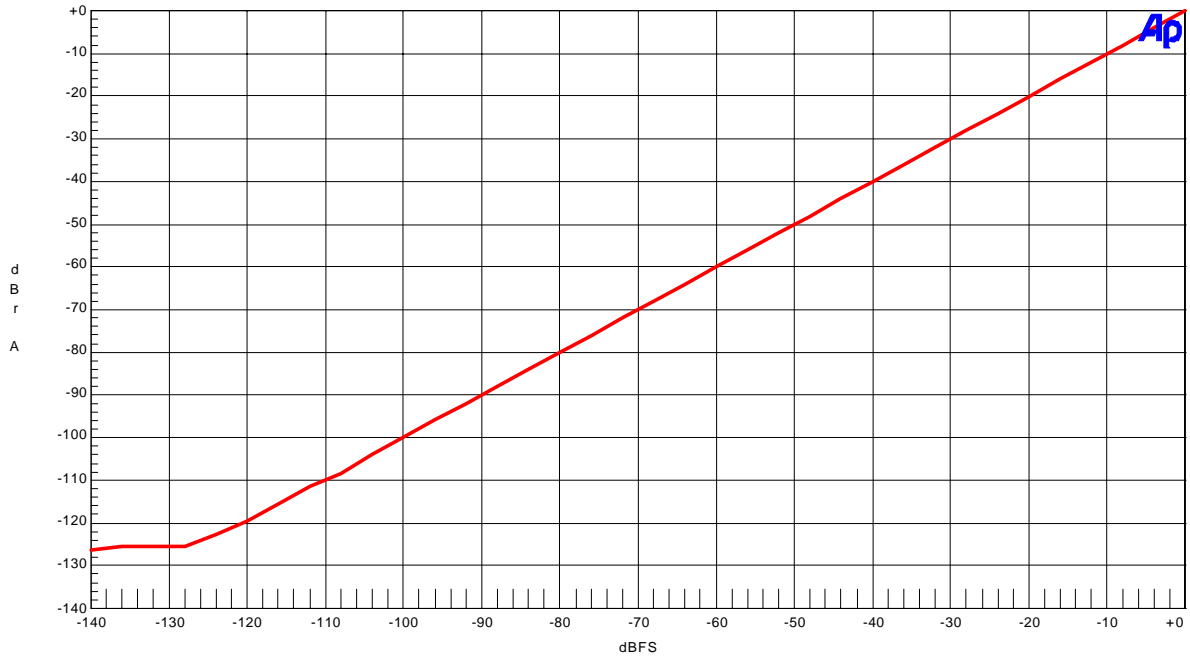

Figure 12. Linearity (fin=1kHz)

AKM

AK4382 Frequency Response (fs=44.1kHz; Input level=0dBFS)

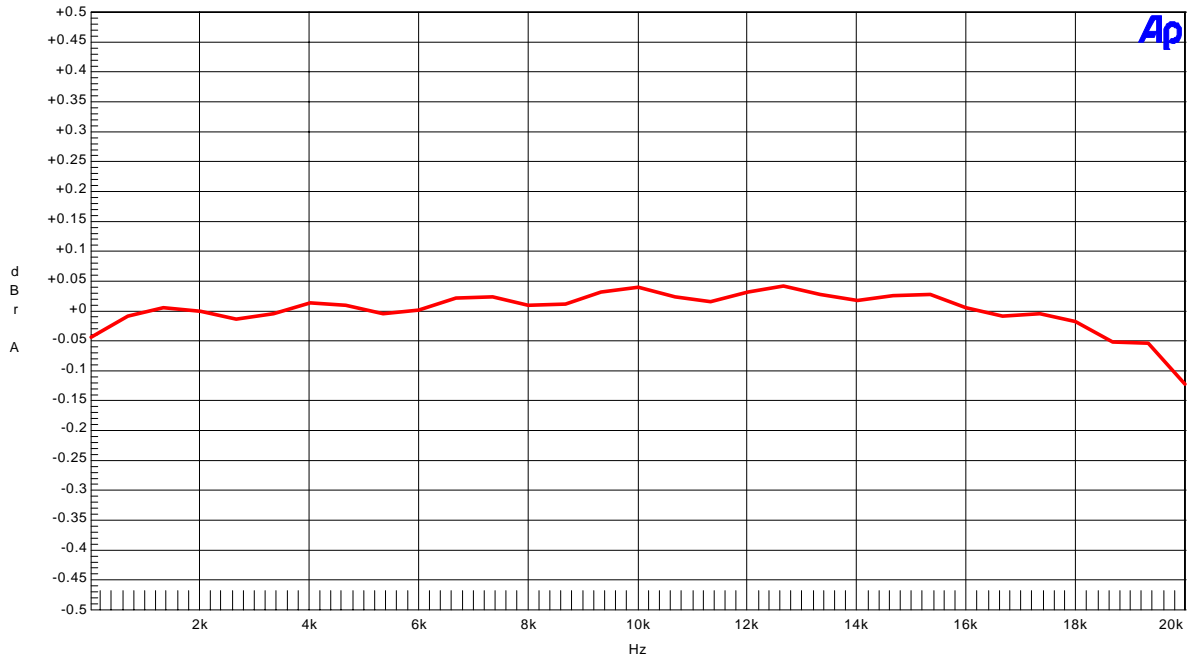

Figure 13. Frequency Response (Input level=0dBFS)

(fs=44.1kHz)

AKM

AK4382 Cross-talk (fs=44.1kHz; Input level=0dBFS)
upper: Rch --> Lch; lower: Lch --> Rch

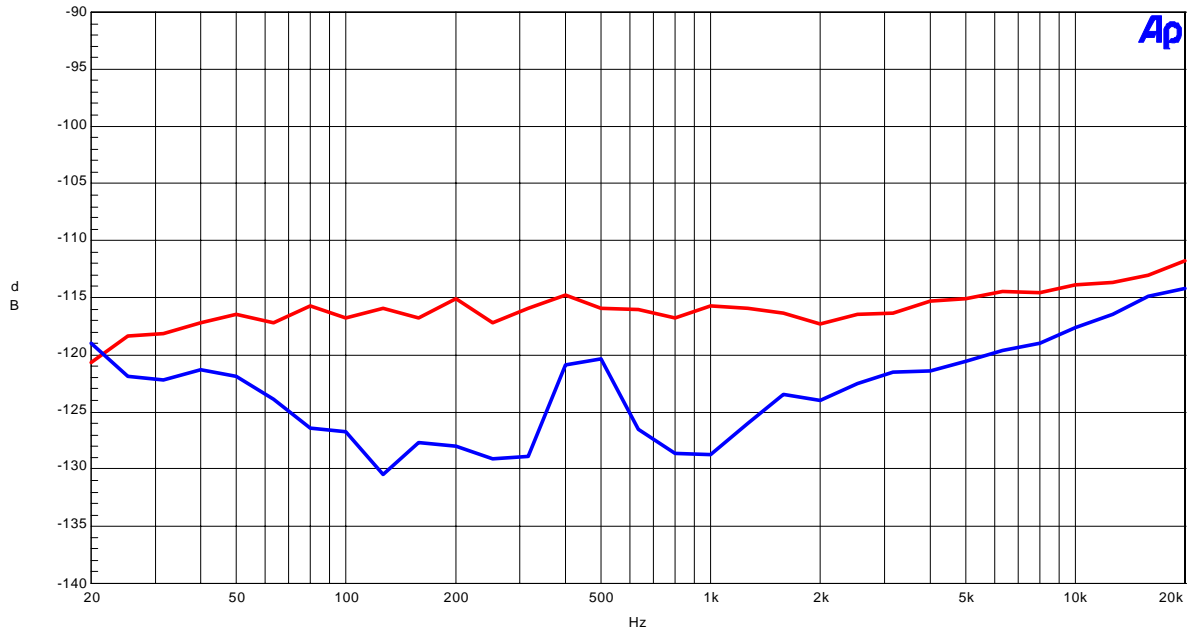

Figure 12. Cross-talk (Input level=0dBFS)

(fs=96kHz)

AKM

AK4382 FFT (fs=96kHz; Input=1kHz, 0dBFS)
FFT points=16384, Avg=8, Window=Equiripple, Notch=OFF

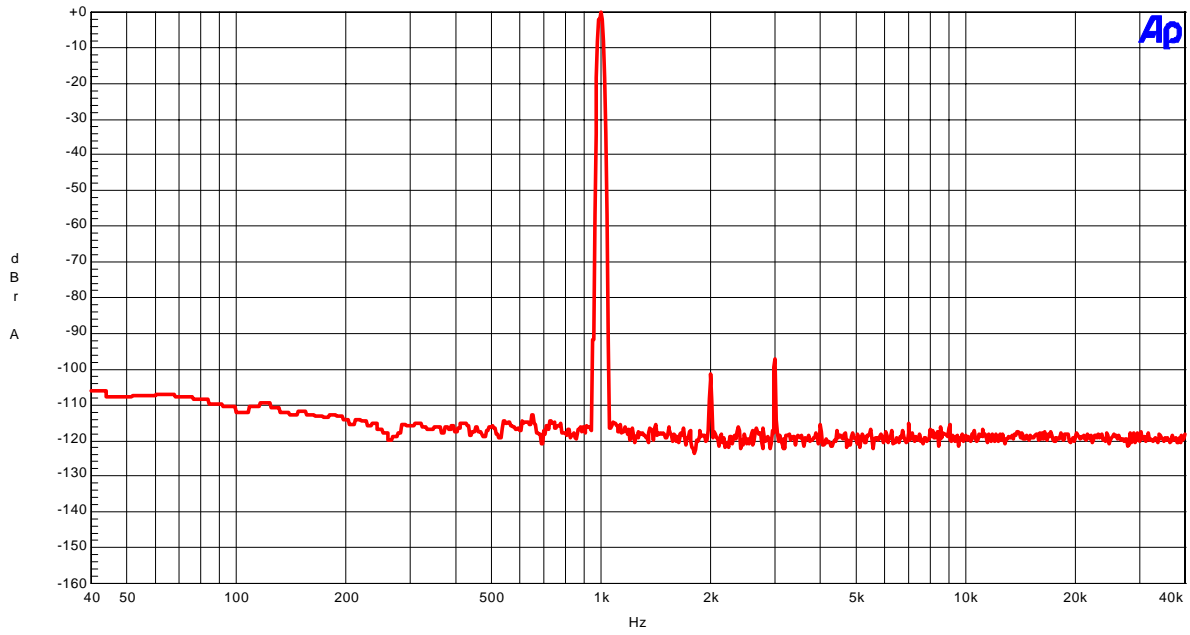

Figure 15. FFT (1kHz, 0dBFS input, Notch=OFF)

AKM

AK4382 FFT (fs=96kHz; Input=1kHz, 0dBFS)
FFT points=16384, Avg=8, Window=Equiripple, Notch=ON

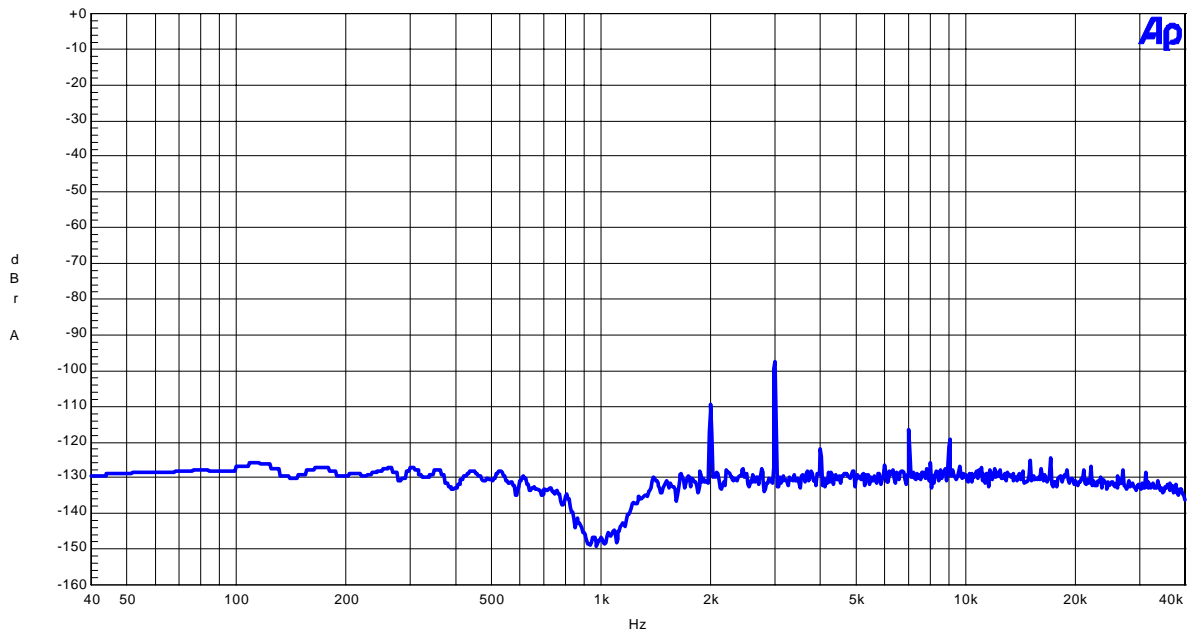

Figure 16. FFT (1kHz, 0dBFS input, Notch=ON)

(fs=96kHz)

AKM

AK4382 FFT (fs=96kHz; Input=1kHz, -60dBFS)
FFT points=16384, Avg=8, Window=Equiripple

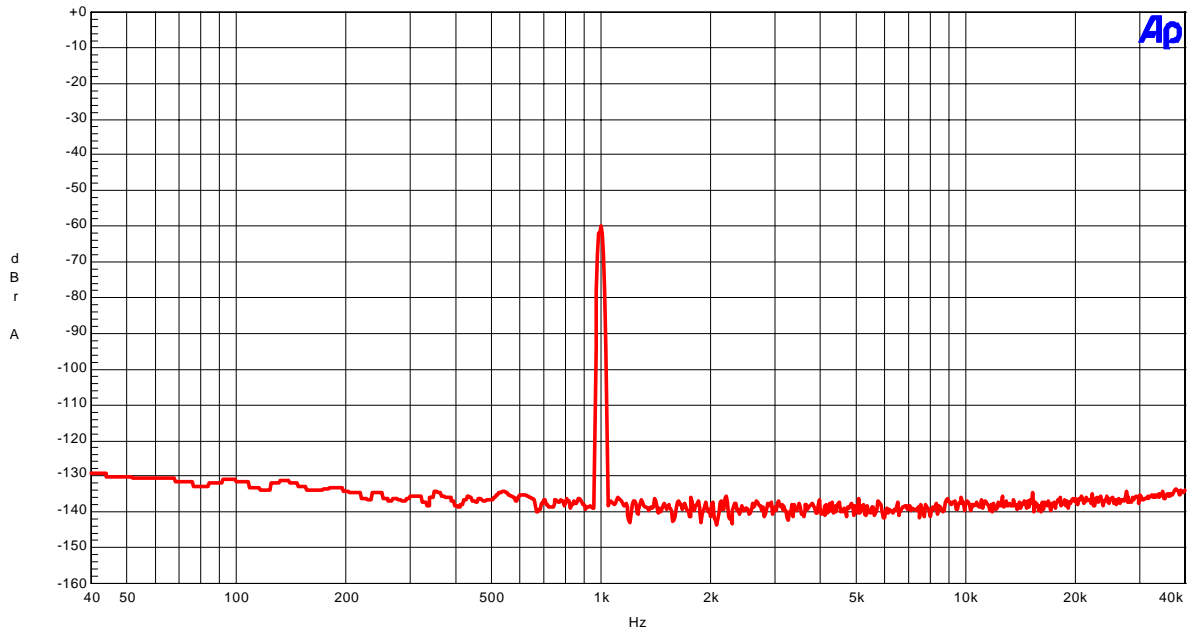

Figure 17. FFT (1kHz, -60dBFS input)

AKM

AK4382 FFT (fs=96kHz; Noise floor)
FFT points=16384, Avg=8, Window=Equiripple

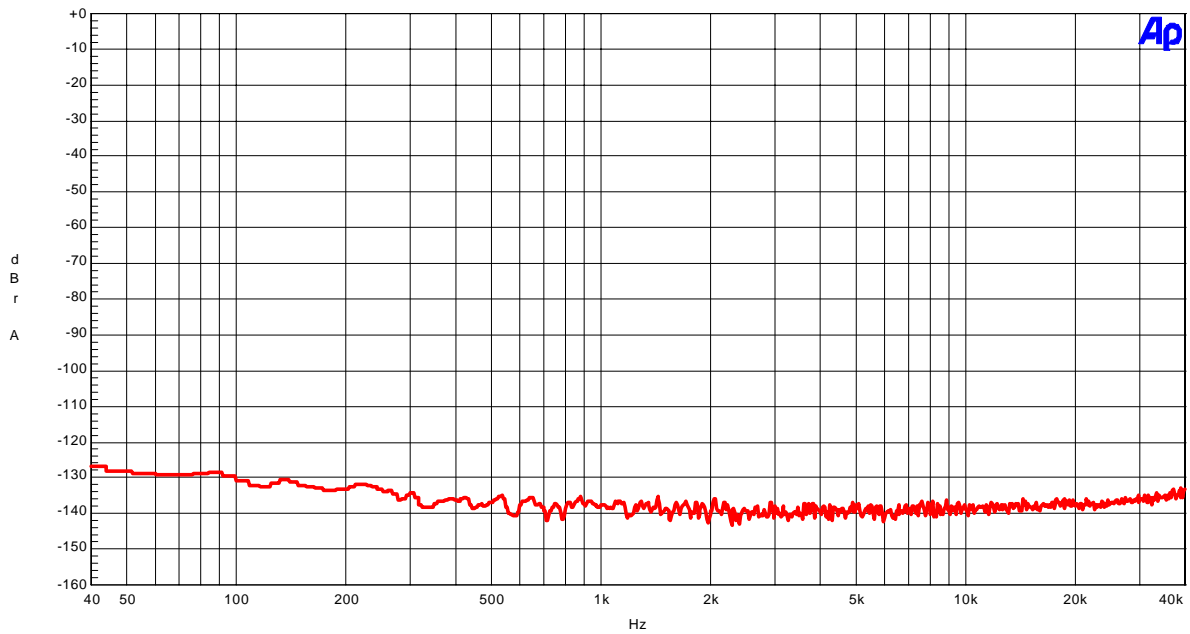

Figure 18. FFT (noise floor)

(fs=96kHz)

AKM

AK4382 FFT (fs=96kHz; Out-of-band noise)
FFT points=16384, Avg=8, Window=Equiripple

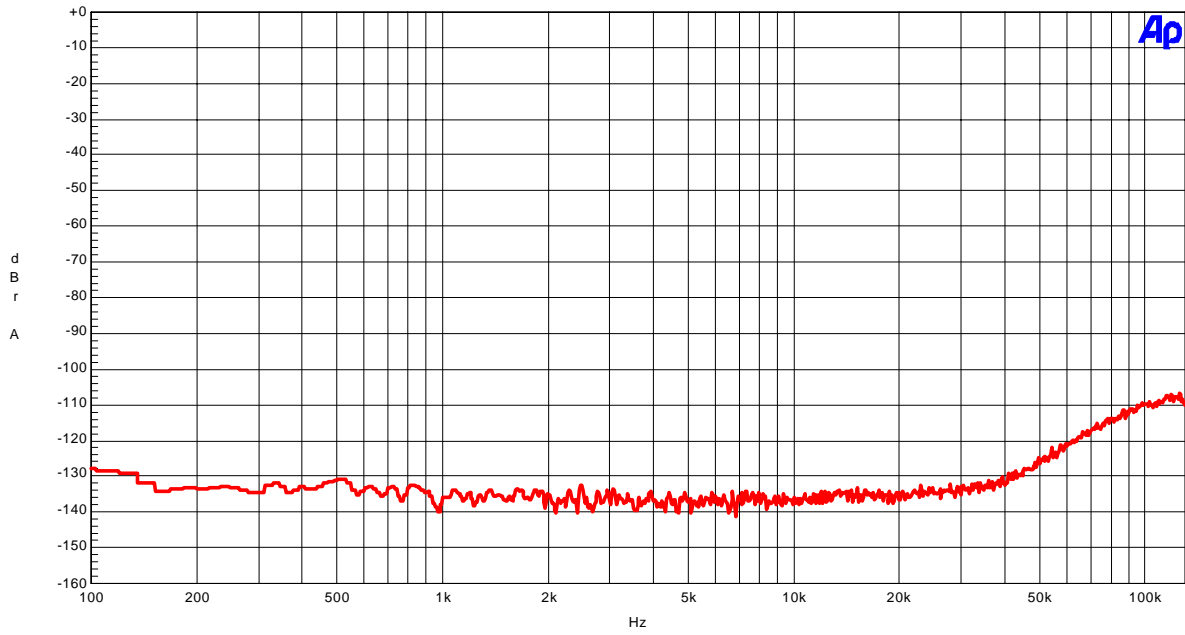

Figure 19. FFT (out-of-band noise)

(fs=96kHz)

AKM

AK4382 THD+N vs Input level (fs=96kHz; fin=1kHz)

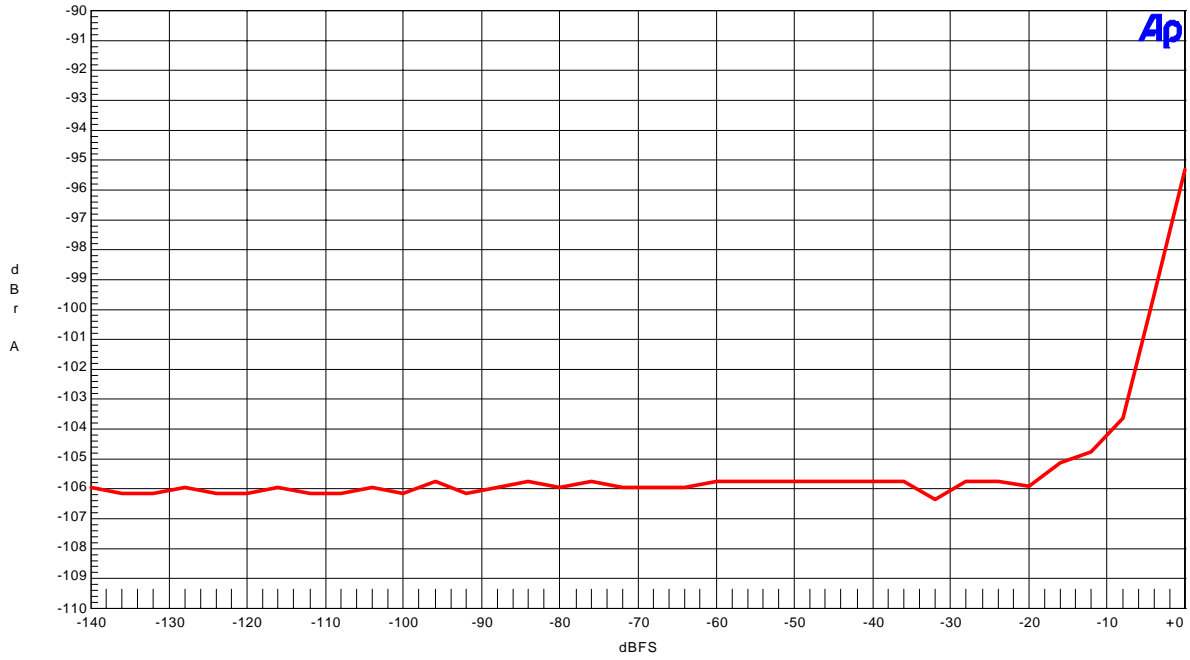

Figure 20. THD+N vs Input Level (fin=1kHz)

AKM

AK4382 THD+N vs fin (fs=96kHz; Input level=0dBFS)

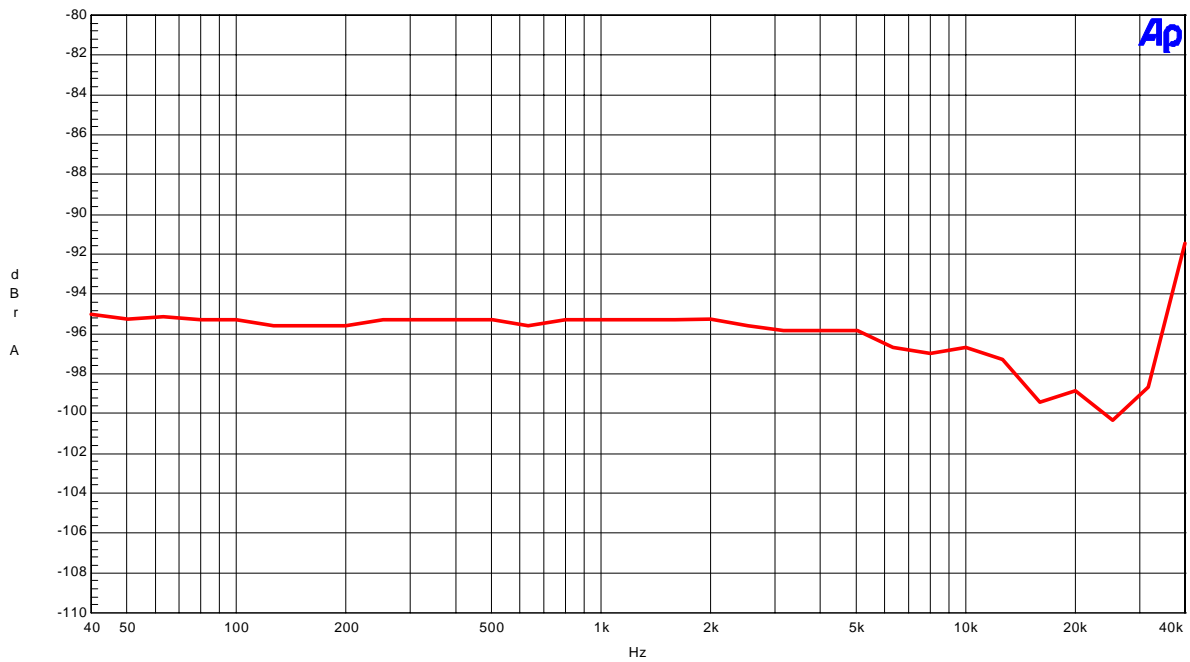

Figure 21. THD+N vs fin (Input level=0dBFS)

(fs=96kHz)

AKM

AK4382 Linearity (fs=96kHz; fin=1kHz)

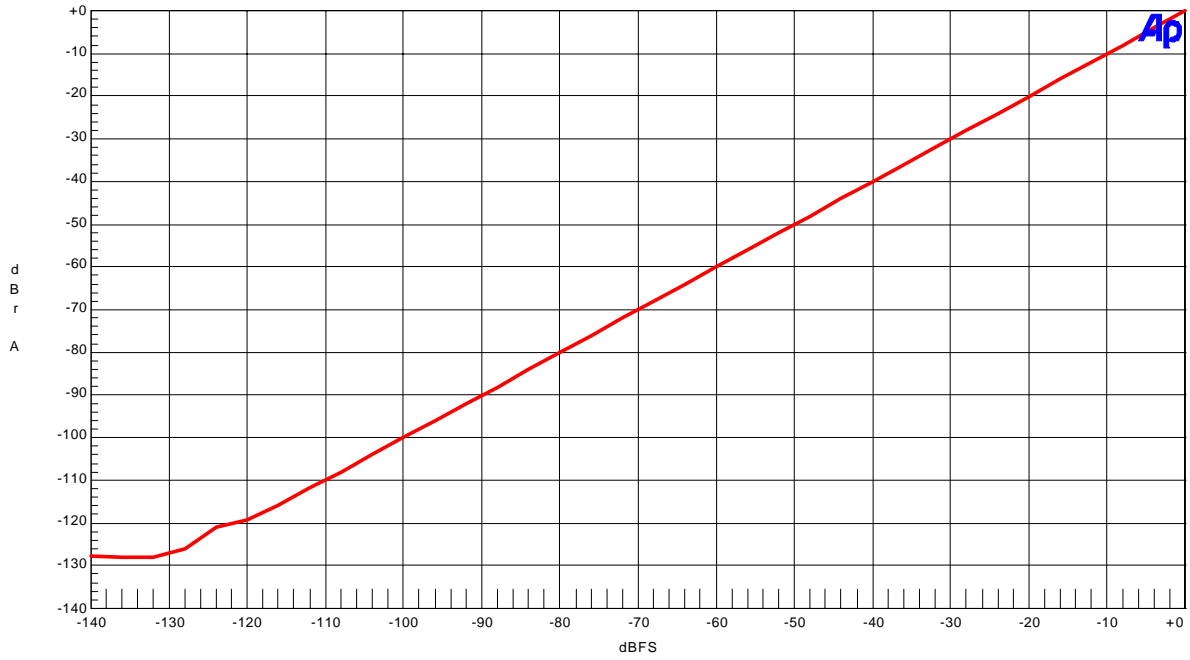

Figure 22. Linearity (fin=1kHz)

AKM

AK4382 Frequency Response (fs=96kHz; Input level=0dBFS)

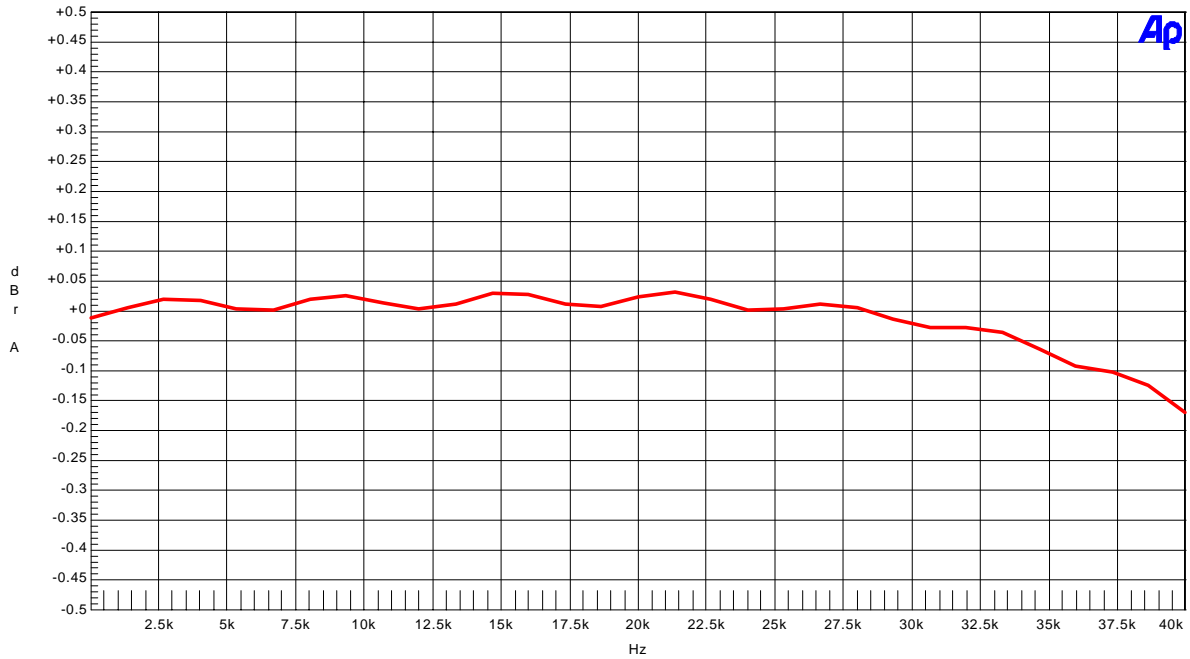

Figure 23. Frequency Response (Input level=0dBFS)
(Including external LPF)

(fs=96kHz)

AKM

AK4382 Cross-talk (fs=96kHz; Input level=0dBFS)
upper: Rch --> Lch; lower: Lch --> Rch

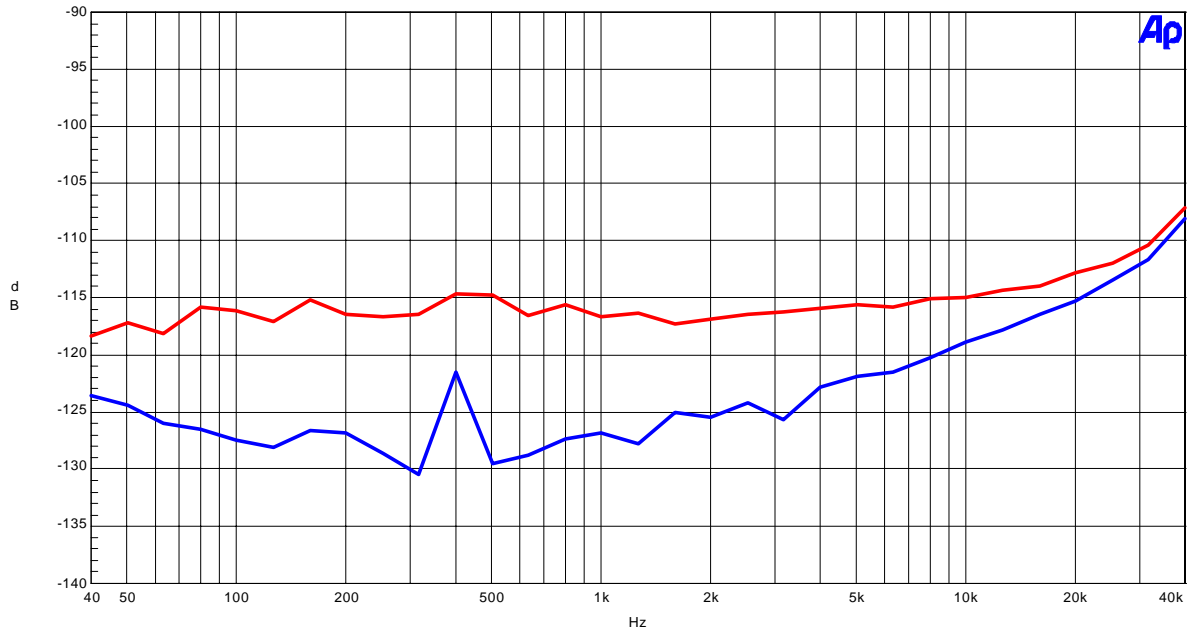

Figure 24. Cross-talk (Input level=0dBFS)

AKD4382 Control Program ver 1.0 operation manual

■ Set-up of evaluation board and control software

1. Set up the AKD4382 according to previous term.
2. Connect IBM-AT compatible PC with AKD4382 by 10-line type flat cable (packed with AKD4382). Take care of the direction of 10pin header. (This control software does not operate on Windows NT, therefore please operate it on Windows95/98.)
3. Insert the floppy-disk labeled “AKD4382 Control Program ver 1.0” into the floppy-disk drive.
4. Access the floppy-disk drive and double-click the icon of “akd4382.exe” to set up the control program.
5. Then please evaluate according to the follows.

■ Explanation of each buttons

1. [Port Setup] : set up the printer port.
2. [Write default] : initialize the register of AK4382.
3. [Function1] : set up the dialog which can be written by keyboard operation.
4. [Function2] : set up the dialog which can be written by keyboard operation.
5. [Write] : set up the dialog corresponding to each register which can be written by mouse operation.

■ Explanation of each dialog

1. [Function1 Dialog] : Dialog to write data by keyboard operation

Address Box: Input register address in 2 figures of hexadecimal.

Data Box: Input register data in 2 figures of hexadecimal.

If you want to write the input data to AK4382, click “OK” button. If not, click “Cancel” button.

2. [Function2 Dialog] : Dialog to evaluate DATT

This dialog corresponds to only addr=03H and 04H

Address Box: Input register address in 2 figures of hexadecimal.

Start Data Box: Input start data in 2 figures of hexadecimal.

End Data Box: Input end data in 2 figures of hexadecimal.

Interval Box: Data is written to AK4382 by this interval.

Step Box: Data changes by this step.

Mode Select Box:

If you check this check box, data reaches end data, and returns to start data.

[Example] Start Data = 00, End Data = 09

Data flow: 00 01 02 03 04 05 06 07 08 09 09 08 07 06 05 04 03 02 01 00

If you do not check this check box, data reaches end data, but does not return to start data.

[Example] Start Data = 00, End Data = 09

Data flow: 00 01 02 03 04 05 06 07 08 09

If you want to write the input data to AK4382, click “OK” button. If not, click “Cancel” button.

3. [Write Dialog] : Dialog to write data by mouse operation

There are dialogs corresponding to each register.

Click the “Write” button corresponding to each register to set up the dialog. If you check the check box, data becomes “H” or “1”. If not, “L” or “0”.

If you want to write the input data to AK4382, click “OK” button. If not, click “Cancel” button.

■ Operation flow

Keep the following flow surely.

1. Set up the control program according to explanation above.
2. Click “Port Setup” button.
3. Click “Write default” button.
4. Then set up the dialog and input data.

■ Indication of data

Input data is indicated on the register map. Red letter indicates “H” or “1” and blue one indicates “L” or “0”. Blank is the part that is not defined in the datasheet.

■ Attention on the operation

If you set up Function1 or Function2 dialog, input data to all boxes. Attention dialog is indicated if you input data or address that is not specified in the datasheet or you click “OK” button before you input data. In that case set up the dialog and input data once more again. These operation does not need if you click “Cancel” button or check the check box.

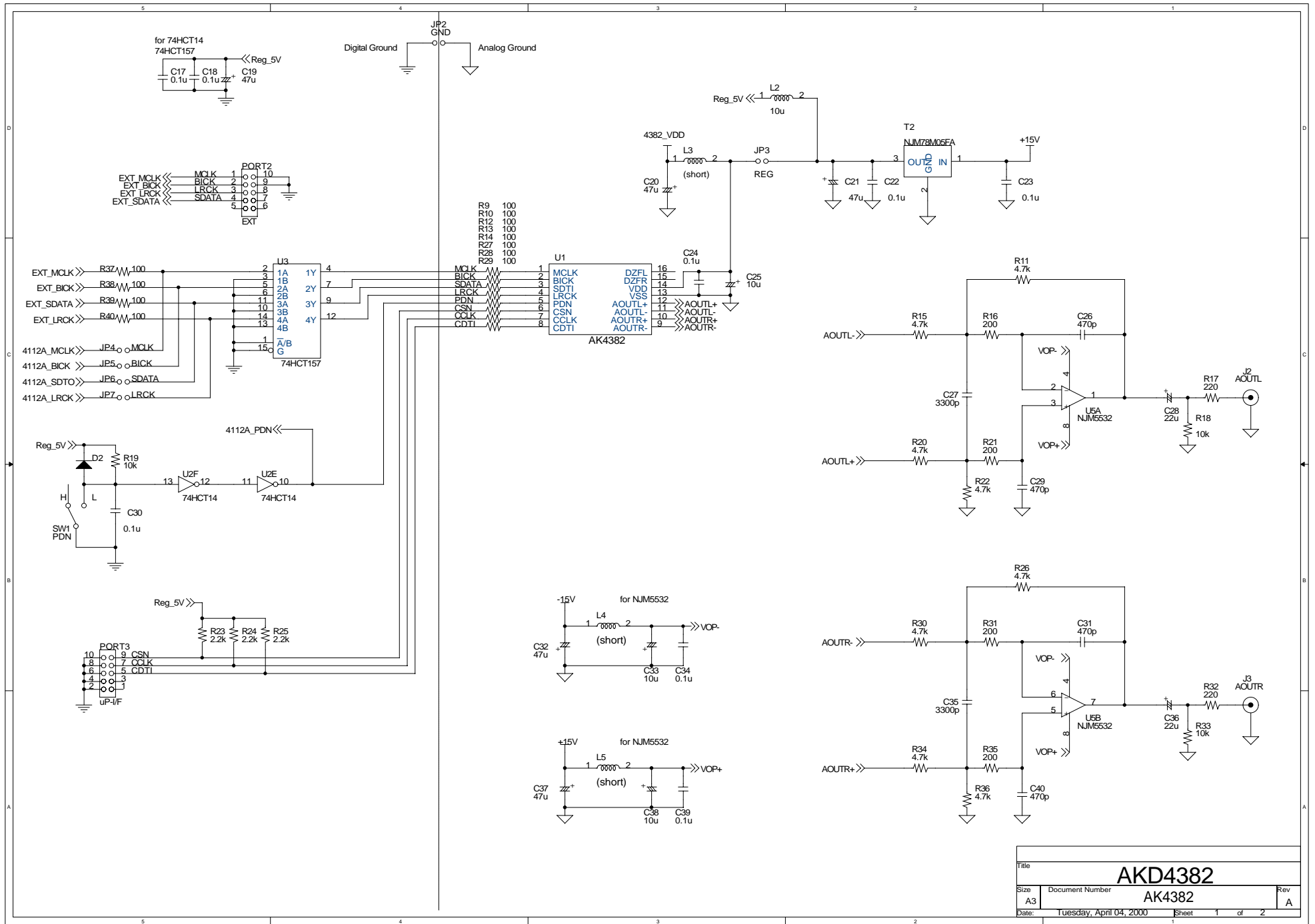

Title			AKD4382		
Size	Document Number	AK4382			Rev
A3					A
Date:	Tuesday, April 04, 2000	Sheet	1	of	2

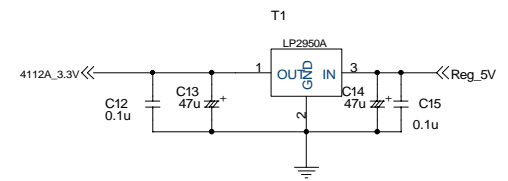
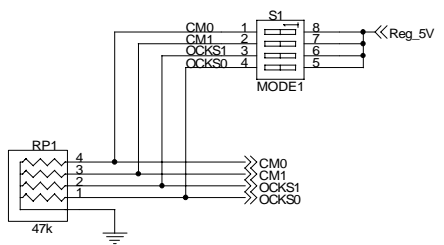
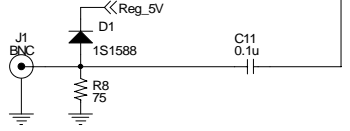
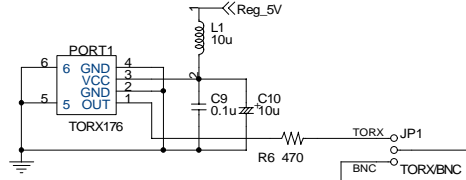
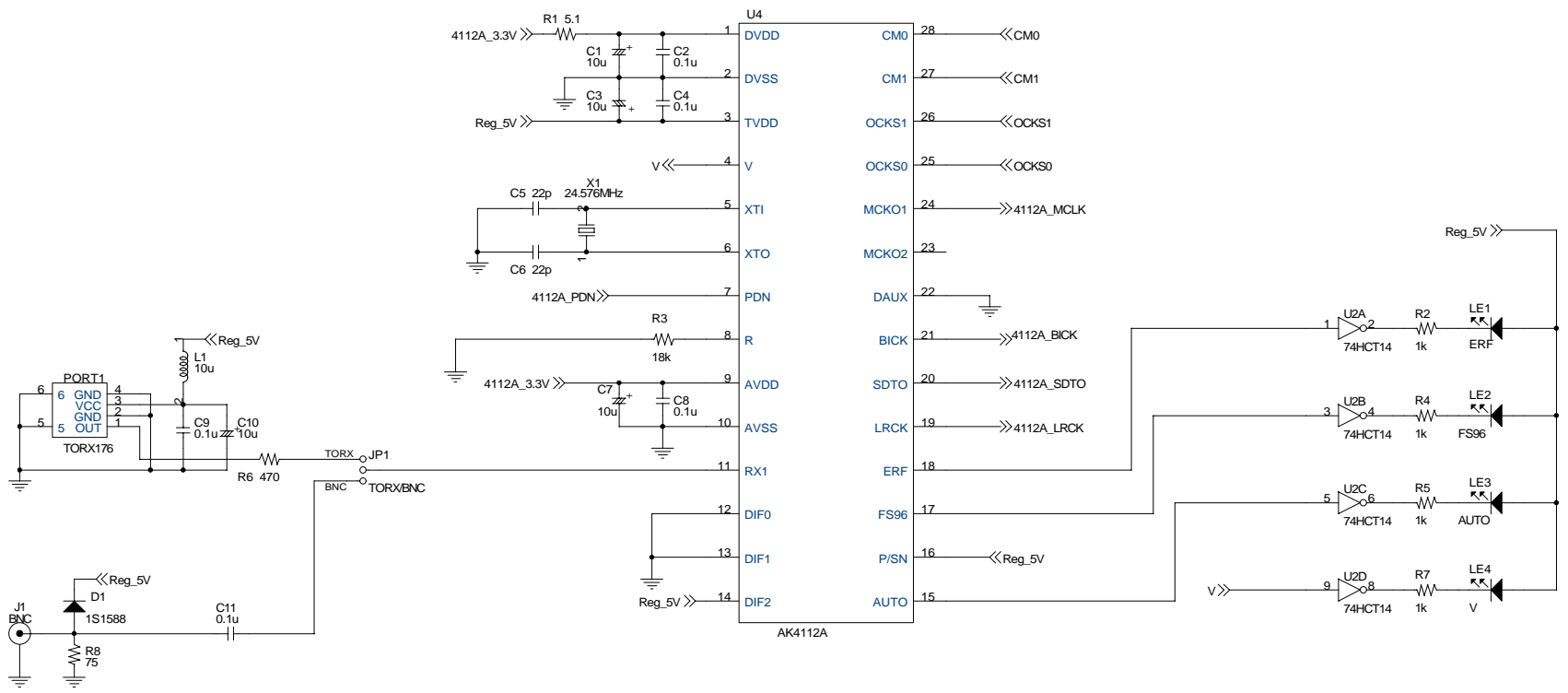

Title			AKD4382	Rev
Size	Document Number			
A3	AK4112A		A	
Date:	Tuesday, April 04, 2000	Sheet	2 of 2	

**AKD4382 Rev. A
Evaluation Board**

SILK

ROG0 JUL DAY
O X 2000. 4. 5

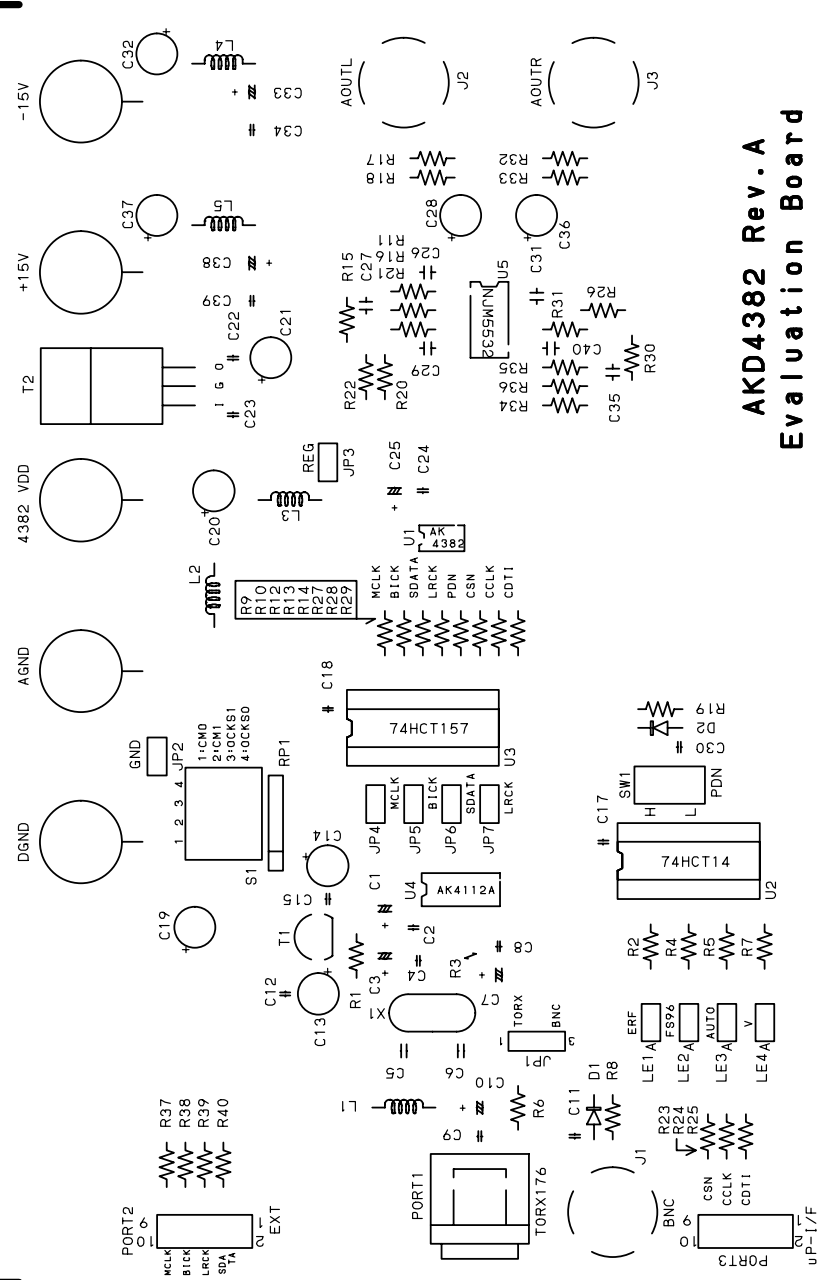

**AKD4382 Rev. A
Evaluation Board**



AKD4382 Rev. A
Evaluation Board

R R

ROG0 JUL DAY
O X 2000. 4. 5

部品面図

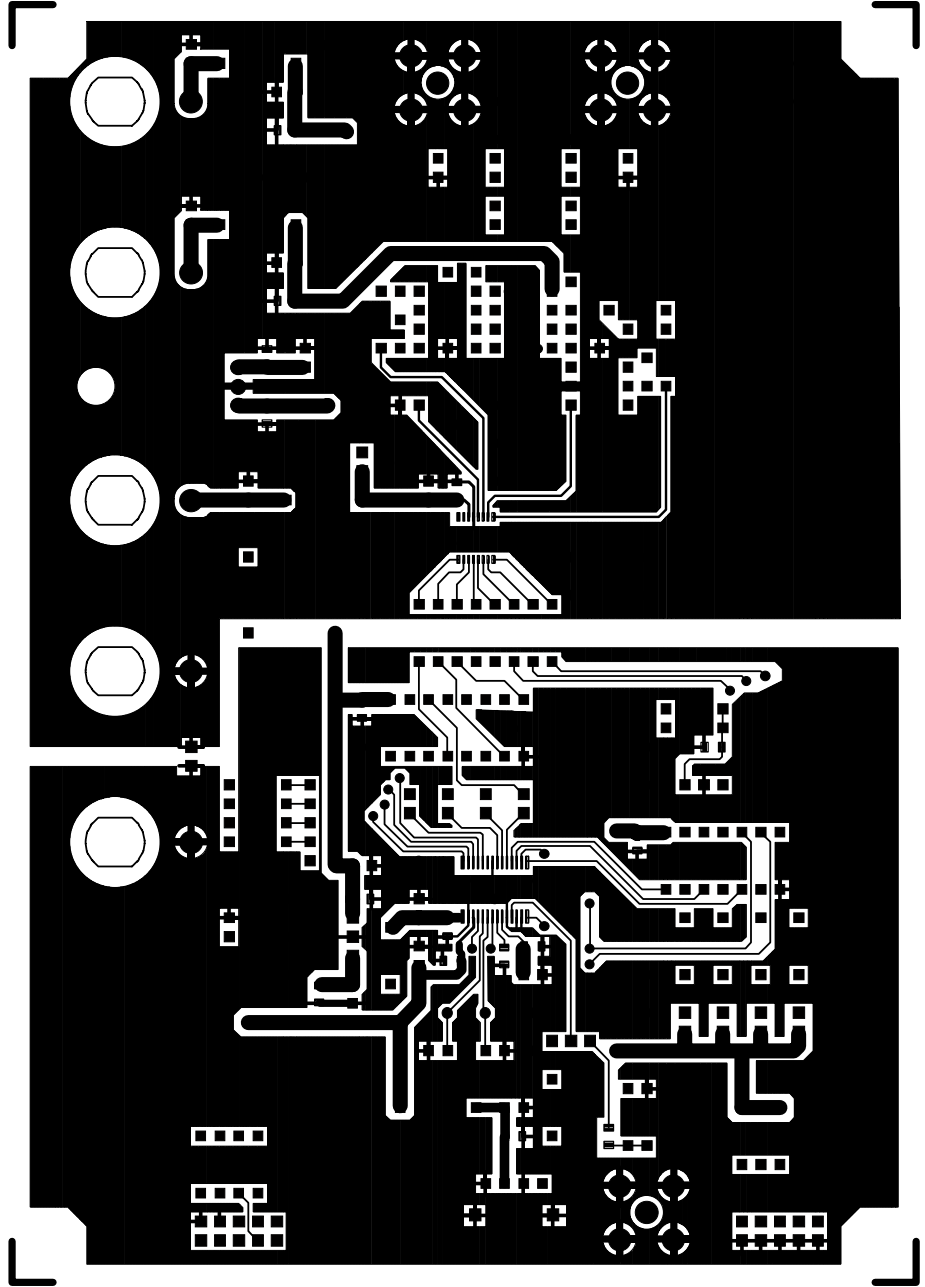

IMPORTANT NOTICE

- These products and their specifications are subject to change without notice. Before considering any use or application, consult the Asahi Kasei Microsystems Co., Ltd. (AKM) sales office or authorized distributor concerning their current status.
- AKM assumes no liability for infringement of any patent, intellectual property, or other right in the application or use of any information contained herein.
- Any export of these products, or devices or systems containing them, may require an export license or other official approval under the law and regulations of the country of export pertaining to customs and tariffs, currency exchange, or strategic materials.
- AKM products are neither intended nor authorized for use as critical components in any safety, life support, or other hazard related device or system, and AKM assumes no responsibility relating to any such use, except with the express written consent of the Representative Director of AKM. As used here:
 - (a) A hazard related device or system is one designed or intended for life support or maintenance of safety or for applications in medicine, aerospace, nuclear energy, or other fields, in which its failure to function or perform may reasonably be expected to result in loss of life or in significant injury or damage to person or property.
 - (b) A critical component is one whose failure to function or perform may reasonably be expected to result, whether directly or indirectly, in the loss of the safety or effectiveness of the device or system containing it, and which must therefore meet very high standards of performance and reliability.
- It is the responsibility of the buyer or distributor of an AKM product who distributes, disposes of, or otherwise places the product with a third party to notify that party in advance of the above content and conditions, and the buyer or distributor agrees to assume any and all responsibility and liability for and hold AKM harmless from any and all claims arising from the use of said product in the absence of such notification.