

ULN-3330, ULN-3360, AND ULN-3363 OPTOELECTRONIC SWITCHES

FEATURES

- Photodiode with:
On-Chip Amplifier
On-Chip Comparator with Hysteresis
On-Chip Power Driver
On-Chip Voltage Regulator
- Sensitive Switch Points
- Operation to 30 kHz
- Plastic or Hermetic Package

SPRAGUE SERIES ULN-3330, ULN-3360, and ULN-3363 optoelectronic switches provide light detection and low-level signal processing in single three-lead packages. The monolithic integrated circuits, requiring no external components, meet the need for cost-effective light-sensing devices in consumer and industrial applications. Their high sensitivity makes them ideal for low-level light detection in optically noise-free environments.

Each optoelectronic IC includes a 30-mil by 30-mil photodiode, a high-gain current amplifier, a comparator with 12% hysteresis, output driver stage, and voltage regulator.

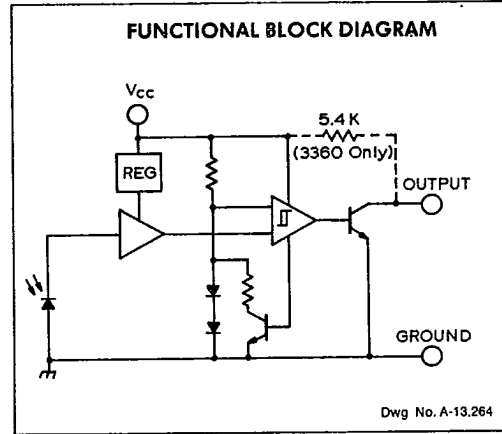

Series ULN-3330 and Series ULN-3360 switches turn ON as illumination of the photodiode falls below $55 \mu\text{W}/\text{cm}^2$ at 880 nm. An internal latch provides hysteresis: The output turns OFF when illumination surpasses the turn-on threshold by approximately 12%.

(Continued next page)

5

Device Type	Output	Package*	Pinout (1-2-3)
ULN-3330D	Open Collector	D	OUT—GND— V_{cc}
ULN-3330T	Open Collector	T	OUT—GND— V_{cc}
ULN-3360D	5.4 k Ω Pull-Up	D	OUT—GND— V_{cc}
ULN-3360T	5.4 k Ω Pull-Up	T	OUT—GND— V_{cc}
ULN-3363D	Inv. Open Collector	D	OUT—GND— V_{cc}
ULN-3363T	Inv. Open Collector	T	OUT—GND— V_{cc}

*Also available in chip form as ULN-3330C, ULN-3360C, or ULN-3363C.

**ULN-3330D THROUGH ULN-3363T
OPTOELECTRONIC SWITCHES**

Series ULN-3363 switches have inverted output characteristics. They turn OFF as illumination falls below $55 \mu\text{W}/\text{cm}^2$ at 880 nm; they remain OFF until increasing illumination at the photodiode typically reaches $62 \mu\text{W}/\text{cm}^2$.

Devices in Series ULN-3330 and ULN-3363 have buffered open-collector outputs for current-sink applications. Typical loads include incandescent lamps, LEDs, sensitive relays, or dc motors.

Output circuitry for switches in Series ULN-3360 includes an internal 5.4 k Ω pull-up resistor that enables their direct use with microprocessors and TTL logic.

Series ULN-3330, ULN-3360, and ULN-3363 ICs are each offered in two packages with two pinout

options. Package options are specified by a suffix added to the basic part number (e.g., ULN-3330D). The hermetically sealed, three-pin metal "D" package with a glass end-cap conforms to JEDEC outline TO-52 (TO-206AC). The miniature, clear plastic three-lead "T" package is only 0.080" (2.03 mm) thick.

ABSOLUTE MAXIMUM RATINGS

Supply Voltage, V_{CC}	15 V
Output Voltage, V_{OUT}	15 V
Output Current, I_{OUT}	25 mA
Operating Temperature Range, T_A	-40°C to +70°C
Storage Temperature Range, T_S	
Suffix 'D'.....	-55°C to +150°C
Suffix 'T'.....	-55°C to +110°C

TYPICAL TRANSFER CHARACTERISTICS

SERIES ULN-3330 AND ULN-3360

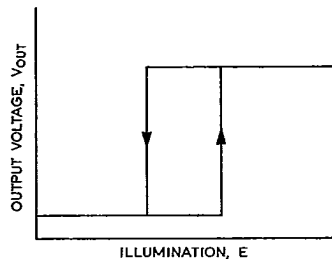

Dwg. No. A-11.128

SERIES ULN-3363

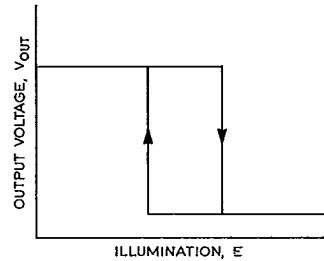

Dwg No A-13 265

ELECTRICAL CHARACTERISTICS at $T_A = +25^\circ\text{C}$, $V_{CC} = 6.0\text{ V}$, $\lambda = 880\text{ nm}$

Characteristic	Symbol	Test Conditions	Limits			Units
			Min.	Typ.	Max.	
Supply Voltage Range	V_{CC}		4.0	6.0	15	V
Supply Current	I_{CC}		—	4.0	8.0	mA
Light Threshold Level	E_{ON}	Output ON	45	55	65	$\mu\text{W}/\text{cm}^2$
	E_{OFF}	Output OFF	—	62	—	$\mu\text{W}/\text{cm}^2$
Hysteresis	ΔE	$(E_{OFF} - E_{ON})/E_{OFF}$	10	13	16	%
Output ON Voltage	V_{OUT}	$I_{OUT} = 15\text{ mA}$	—	300	500	mV
		$I_{OUT} = 25\text{ mA}$	—	500	800	mV
Output OFF Current	I_{OUT}	$V_{OUT} = 15\text{ V}$	—	—	1.0	μA
Output Fall Time	t_f	90% to 10%	—	200	500	ns
Output Rise Time	t_r	10% to 90%	—	200	500	ns

ULN-3330D THROUGH ULN-3363T
OPTOELECTRONIC SWITCHES

RELATIVE SPECTRAL RESPONSE AT $T_A = +25^\circ\text{C}$
AS A FUNCTION OF WAVELENGTH OF LIGHT

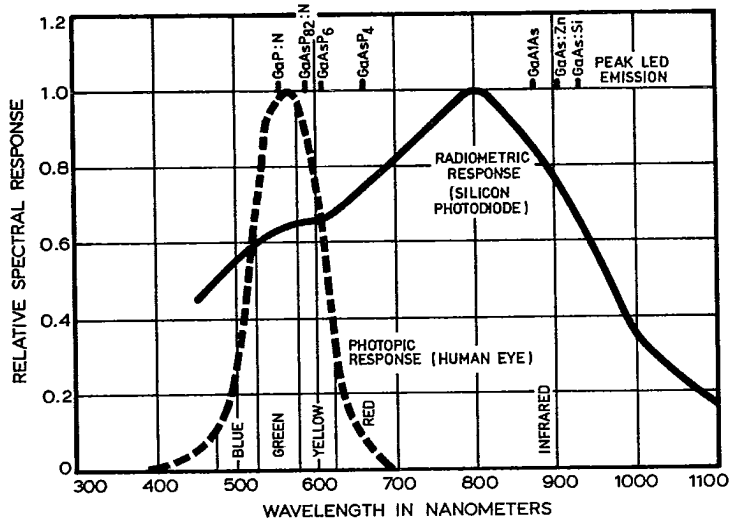

Dwg No A-12,135A

OUTPUT SATURATION VOLTAGE
AS A FUNCTION OF OPERATING TEMPERATURE

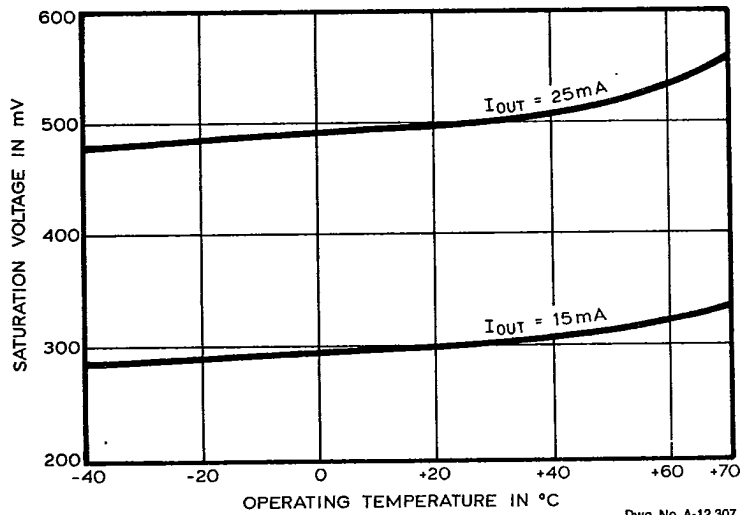

Dwg. No. A-12,307

5

PROPAGATION DELAY
 AS A FUNCTION OF LIGHT LEVEL

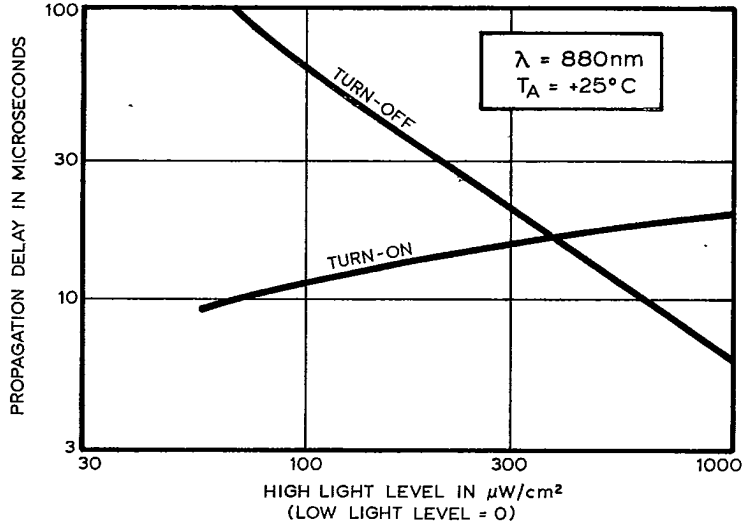

Dwg No. A-12,308

LIGHT-THRESHOLD CHANGE
 AS A FUNCTION OF OPERATING TEMPERATURE

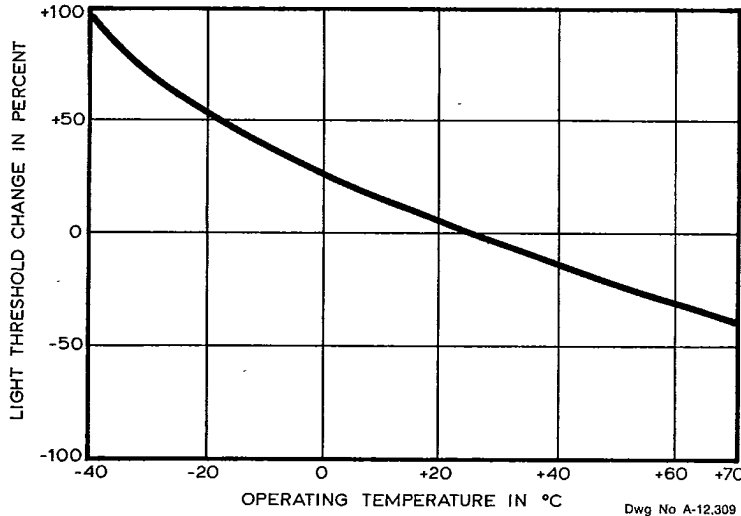

Dwg No A-12,309

TYPICAL APPLICATIONS*

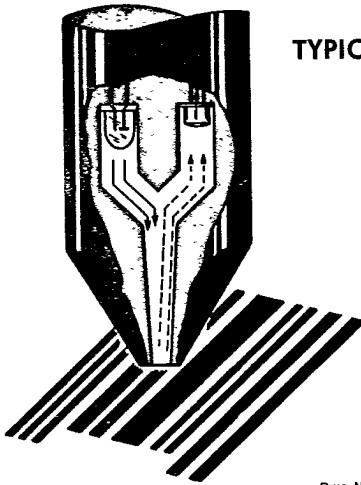

BAR CODE READER

Dwg. No. A-13,266

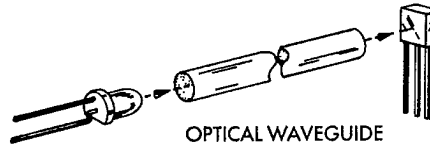

OPTICAL WAVEGUIDE

Dwg. No. A-13,267

OPTICAL ISOLATOR

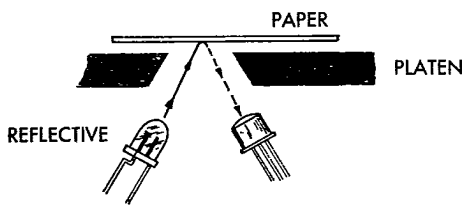

REFLECTIVE

Dwg No A-13,268

SHEET DETECTOR

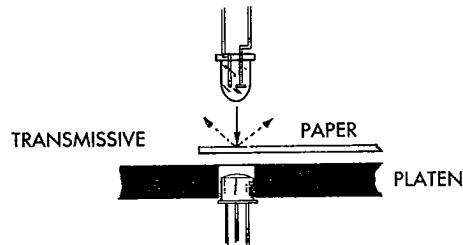

TRANSMISSIVE

Dwg No A-13,269

5

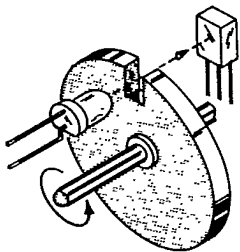

ENCODING WHEEL

Dwg. No. A-13,270

OPTICAL ENCODER

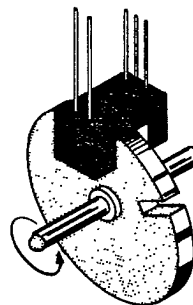

EMITTER-DETECTOR ASSEMBLY

Dwg No A-13,271

*Optics and ambient light shields omitted for clarity.

8514019 SPRAGUE/ SEMICONDS/ICS
 ULN-3330D THROUGH ULN-3363T
 OPTOELECTRONIC SWITCHES

03E 04700

D T-41-67

'D' PACKAGE

SENSOR-CENTER LOCATION

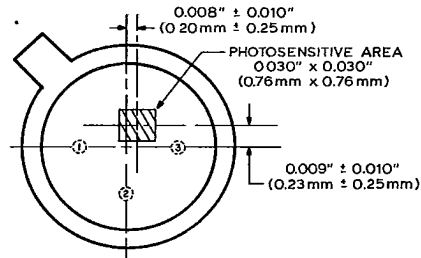

Dwg No. A-13.302

'T' PACKAGE

SENSOR-CENTER LOCATION

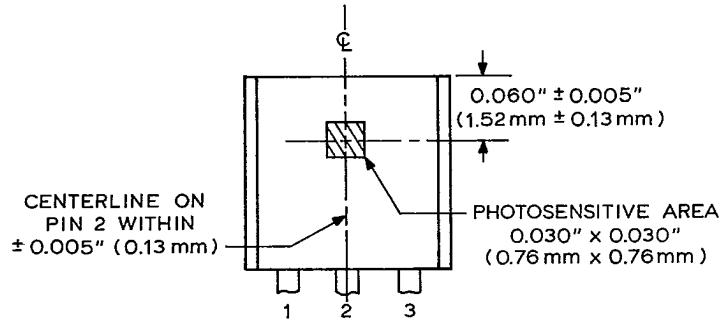

Dwg No A-13.301 A