

Chip resistor networks

MNR35 (3216 × 5 size)

●Features

- 1) Common terminals yield area 40% smaller than that of the MNR38.
- 2) 8-element construction makes the MNR35 ideal for bus line pull-up / pull-down.
- 3) Convex electrodes
Easy to check the fillet after soldering is finished.
- 4) Compatible with a wide range of mounting equipment.
- 5) Squared corners make it excellent for mounting using image recognition devices.
- ROHM resistors have approved ISO-9001 certification.
Design and specifications are subject to change without notice. Carefully check the specification sheet supplied with the product before using or ordering it.

●Ratings

Item	Conditions	Specifications	
Rated power	Power must be derated according to the power derating curve in Figure 1 when ambient temperature exceeds 70°C.	0.063W (1 / 16W) at 70°C	
	 <p style="text-align: center;">Fig.1</p>		
Rated voltage	The voltage rating is calculated by the following equation. If the value obtained exceeds the maximum operating voltage, the voltage rating is equal to the maximum operating voltage. $E = \sqrt{P \times R}$ E: Rated voltage (V) P: Rated power (W) R: Nominal resistance (Ω)	Max. operating voltage	50V
		Max. overload voltage	100V
		Max. intermittent overload voltage	100V
Nominal resistance	See Table 1.		
Operating temperature		-55°C to +125°C	

Table 1

Resistance tolerance	Resistance range (Ω)	Resistance temperature coefficient (ppm / $^{\circ}\text{C}$)
J ($\pm 5\%$)	$15 \leq R \leq 100\text{k}$ (E12)	± 200

Before using components in circuits where they will be exposed to transients such as pulse loads (short-duration, high-level loads), be certain to evaluate the component in the mounted state. In addition, the reliability and performance of this component cannot be guaranteed if it is used with a steady state voltage that is greater than its rated voltage.

● Characteristics

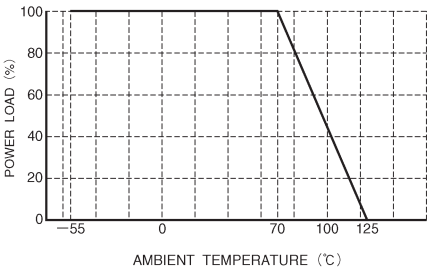
Characteristics	Specifications	Test method (JIS C5202)
DC resistance	J: $\pm 5\%$	JIS C 5202 5.1 Applied voltage: A
Resistance temperature characteristics	See Table 1.	JIS C 5202 5.2 Test conditions: $+25 / -55 / +25 / +125^{\circ}\text{C}$
Short time overload	$\pm (5.0\% + 0.1 \Omega)$	JIS C 5202 5.5 Rated voltage (current) : $\times 2.5$, 5s. Maximum overload voltage: 100V
Resistance to soldering heat	$\pm (2.5\% + 0.1 \Omega)$ Outside must not be noticeably damaged.	JIS C 5202 6.4 Soldering conditions: $260 \pm 5^{\circ}\text{C}$ Soldering time: $10 \pm 1\text{s}$.
Solderability	95% of terminal surface must be covered by new soldering, and there must be no soldering corrosion.	JIS C 5202 6.5 Rosin methanol: (25%WT) Soldering conditions: $235 \pm 5^{\circ}\text{C}$ Soldering time: $2 \pm 0.5\text{s}$.
Resistance to dry heat	$\pm (5.0\% + 0.1 \Omega)$	JIS C 5202 7.2 125°C Test time: 1,000 to 1,048 hrs.
Endurance (rated load)	$\pm (5.0\% + 0.1 \Omega)$	JIS C 5202 7.10 Rated voltage, 70°C 1.5h: ON — 0.5h: OFF Test time: 1,000 to 1,048 hrs.
Endurance (under load in damp environment)	$\pm (5.0\% + 0.1 \Omega)$	JIS C 5202 7.9 Rated voltage, 60°C , 95%RH 1.5h: ON — 0.5h: OFF Test time: 1,000 to 1,048 hrs.
Resistance to humidity (steady state)	$\pm (5.0\% + 0.1 \Omega)$	JIS C 5202 7.5 85°C , 85%RH Test time: 1,000 to 1,048 hrs.
Temperature cycling	$\pm (2.5\% + 0.1 \Omega)$	JIS C 5202 7.4 Test temperature: -55°C to $+125^{\circ}\text{C}$ 100cyc.
Resistance to solvents	$\pm (1.0\% + 0.05 \Omega)$ Markings must not be dissolved away.	JIS C 5202 6.9 Room temperature, static immersion, 1 min. Solvent: Isopropyl alcohol

● External dimensions (Units: mm)

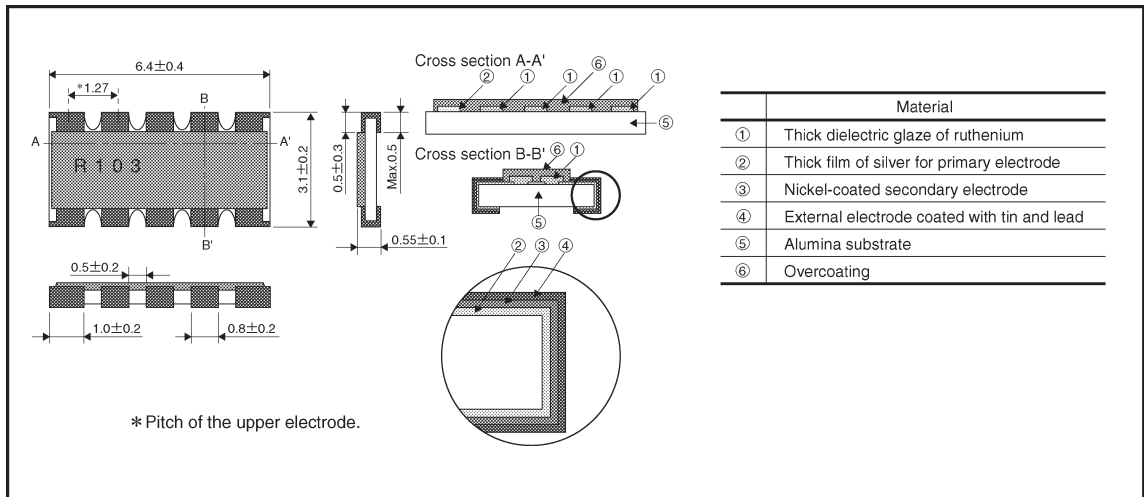

● Equivalent circuit

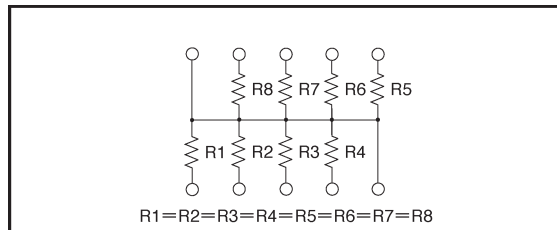

●Packaging

Reel

Label

EIAJ ET-7001 compliant

(Units : mm)

A	B	C	D
$\phi 180 \begin{smallmatrix} 0 \\ -3 \end{smallmatrix}$	$\phi 60 \begin{smallmatrix} +1 \\ 0 \end{smallmatrix}$	13±0.3	$\phi 13 \pm 0.2$

Taping

(Units : mm)

W	F	E	A ₀	B ₀
12.0±0.3	5.5±0.05	1.75±0.1	3.4±0.1	6.6±0.1
D ₀	P ₀	P ₁	P ₂	K
$\phi 1.5 \begin{smallmatrix} +0.1 \\ 0 \end{smallmatrix}$	4.0±0.1	4.0±0.1	2.0±0.05	1.0±0.15

●Product designation

Part No.

M

N

R

3

5

J

5

R

B

J

Packaging / Processing specifications

Code	Part No.	Packaging	Package style
J5	MNR35	Taping	Embossed reel

Circuit configuration code

R	MNR35
---	-------

Resistance tolerance

J	±5%
---	-----

Nominal resistance

3-digit IEC coding system

●Electrical characteristics

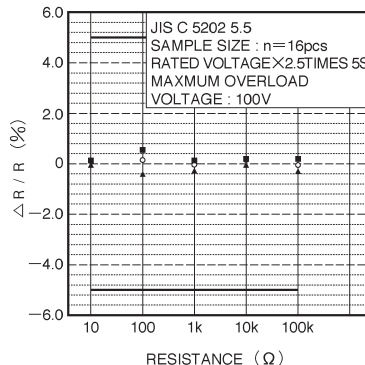
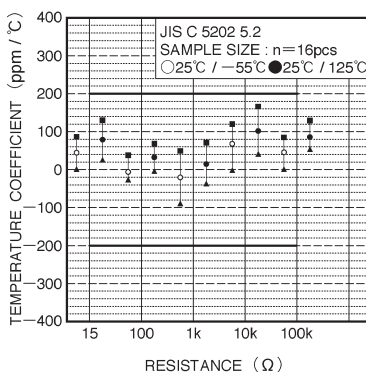
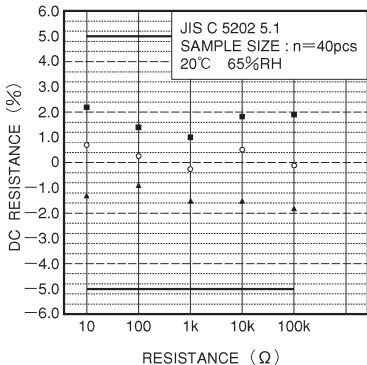

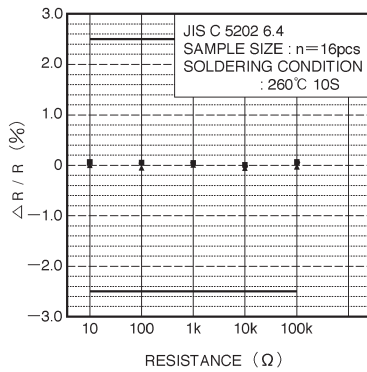

Fig.5 Resistance to soldering heat

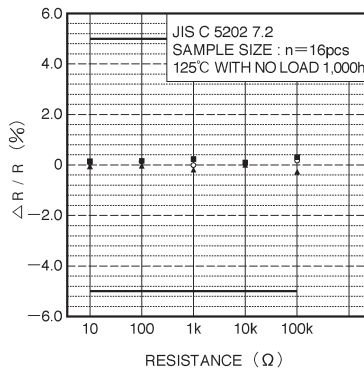

Fig.6 Resistance to dry heat

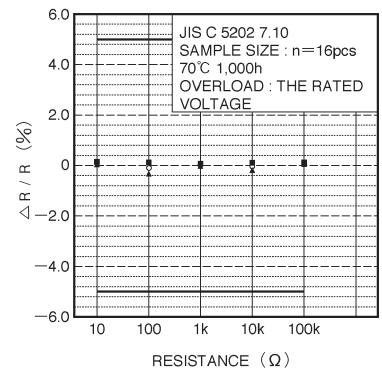

Fig.7 Endurance (rated load)

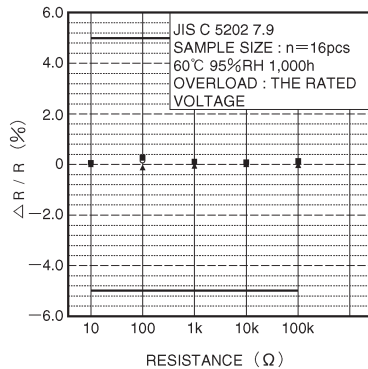

Fig.8 Endurance (under load in damp environment)

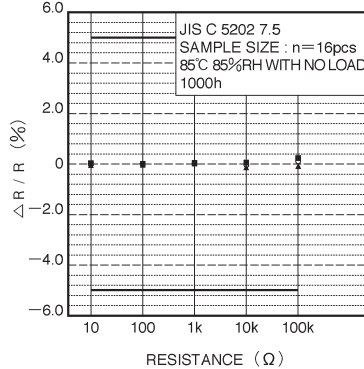

Fig.9 Resistance to humidity (steady state)

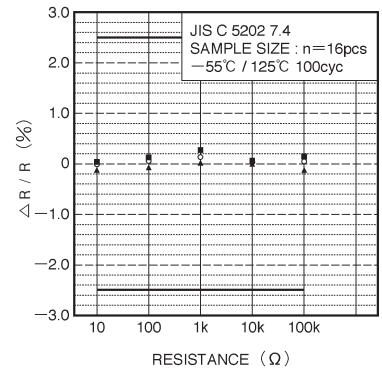

Fig.10 Temperature cycling

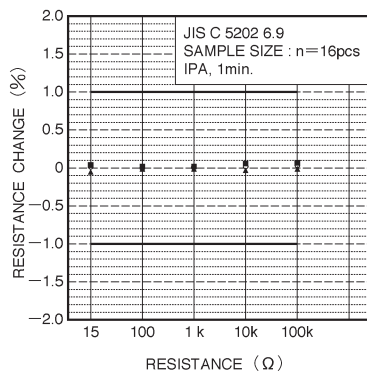

Fig.11 Resistance to solvents