

# MAXIM

## MAX3905 Evaluation Kit

### General Description

The MAX3905 evaluation kit (EV Kit) is an assembled demonstration board that provides electrical and optical evaluation of the MAX3905 150Mbps Automotive VCSEL Driver. All output current settings are adjustable by jumpers.

### Component List

DESIGNATION	QTY	DESCRIPTION
C1, C2	2	0.047 $\mu$ F $\pm$ 10% ceramic capacitors (0402)
C3-C5, C9	4	0.1 $\mu$ F $\pm$ 10% ceramic capacitors (0402)
C6	1	0.1 $\mu$ F $\pm$ 10% ceramic capacitor (0603)
C8	1	0.47 $\mu$ F $\pm$ 10% ceramic capacitor (0603)
C10, C11	2	Not Installed
C22	1	10 $\mu$ F tantalum capacitor
C23	1	0.01 $\mu$ F $\pm$ 10% ceramic capacitor (0603)
J1-J4	4	SMA connectors, tab contact, edge mount
J18, J19, TP1-TP3, TP5, TP7	7	Test points Digi-Key 5000K-ND
JP1, JP3, JP5-JP13, JP16, JP17	13	2-pin headers, 0.1in centers
JP2	1	3-pin + 1-pin header, 0.1in centers
JP18	1	VCSEL (Not Installed)
L1	1	1 $\mu$ H inductor Coilcraft 1008CS-102XKB
R1, R11-R13	4	49.9 $\Omega$ $\pm$ 1% resistors (1206)
R2, R5, R9	3	49.9 $\Omega$ $\pm$ 1% resistors (0603)
R3	1	16.2k $\Omega$ $\pm$ 1% resistor (0603)
R4	1	29.4k $\Omega$ $\pm$ 1% resistor (0603)
R6	1	10k $\Omega$ $\pm$ 1% resistor (0603)
R7	1	4.99 $\Omega$ $\pm$ 1% resistor (0603)
R10	1	Not Installed
U1	1	MAX3905* (packaged in 32 QFN for EV Kit only)
None		MAX3905 evaluation circuit board, rev A
None		MAX3905 data sheet

### Features

- ◆ Fully Assembled and Tested
- ◆ Easy Selection of Operating Modes
- ◆ Includes 3-Pin Socket for VCSEL Insertion

*\*Note: U1 has an exposed pad, which requires it to be solder attached to the circuit board to ensure proper functionality of the part.*

### Ordering Information

PART	TEMP. RANGE	IC PACKAGE
MAX3905EVKIT	-40°C to +140°C**	32 QFN

*\*\*Junction Temperature for die; EV Kit materials should not be heated beyond 85°C.*

### Component Suppliers

SUPPLIER	PHONE	FAX
AVX	843-448-9411	843-448-1943
Digi-Key	218-681-6674	218-681-3380
Murata	770-436-1300	770-436-3030

*Note: Please indicate that you are using the MAX3905 when ordering from these suppliers.*

### Quick Start

#### Electrical Evaluation





- 1) Connect a +3.3V or +5V supply to J19 and ground to J18.
- 2) Apply 10Mbps to 50Mbps data to IN\_TTL (J1) or 50Mbps to 150Mbps data to IN+ and IN- (J2 and J3).
- 3) If TTL data is applied, leave jumper JP1 (DIFF) open. If differential data is applied, shunt jumper JP1.
- 4) Shunt jumper JP3 to provide bias to the OUT pad.
- 5) Shunt jumper JP2 (3DB) in the "Normal Power" position.
- 6) Adjust jumpers JP5 – JP13 to change the output current as desired.

# MAX3905 Evaluation Kit

## Optical Evaluation

- 1) Connect a +3.3V or +5V supply to J19 and ground to J18.
- 2) Apply 10Mbps to 50Mbps data to IN\_TTL (J1) or 50Mbps to 150Mbps data to IN+ and IN- (J2 and J3).
- 3) If TTL data is applied, leave jumper JP1 (DIFF) open. If differential data is applied, shunt jumper JP1.
- 4) Replace resistor R6 with a 0Ω resistor and remove resistor R5 and capacitor C4.
- 5) Solder a VCSEL at JP18, with the cathode of the VCSEL in the hole connected to R6 and the anode in either of the two other holes. Components R10 and C10 may be installed if necessary to compensate the VCSEL lead inductance.
- 6) Shunt jumper JP2 (3DB) in the “Normal Power” position.
- 7) Adjust jumpers JP5 – JP13 to change the output current as desired.

## Jumper and Test Point Descriptions

NAME	TYPE	SHUNT POSITION	DESCRIPTION
DIFF (JP1)	2-pin header	OPEN	Enables TTL data input IN_TTL
		SHUNT (GND)	Enables differential data inputs IN+ and IN-
3DB (JP2)	3-pin + 1-pin header	OPEN 	Enables low power mode
		NORMAL POWER 	Enables normal power mode
		LOW POWER 	Connects 3DB pad to VCC with a 29.4kΩ resistor. Enables low power mode when $4.75V \leq VCC \leq 5.25V$ .
		NORMAL POWER 5V 	Connects 3DB pad to VCC with a 16.2kΩ resistor. Enables normal power mode when $4.75V \leq VCC \leq 5.25V$ .
JP3	2-pin header	OPEN	For electrical evaluation, a bias voltage $0.9V \leq V_{BIAS} \leq VCC$ should be applied at this jumper to turn on the output stage
		SHUNT (VCC)	Applies an output stage bias voltage of VCC
DT01 and DT02 (JP5 and JP6)	2-pin headers	OPEN	Sets the DT0 bit low
		SHUNT (VCC)	Sets the DT0 bit high
MOD1 and MOD2 (JP8 and JP7)	2-pin headers	OPEN	Sets the MOD bit low
		SHUNT (VCC)	Sets the MOD bit high
TC1, TC2 and TC3 (JP9, JP10, and JP11)	2-pin headers	OPEN	Sets the TC bit low
		SHUNT (GND)	Sets the TC bit high
LOW1 and LOW2 (JP12 and JP13)	2-pin headers	OPEN	Sets the LOW bit low
		SHUNT (GND)	Sets the LOW bit high
SQEN (JP16)	2-pin header	OPEN	Enables squelch
		SHUNT (GND)	Disables squelch
TEMPSENS (TP1)	Test Point	-	Monitors voltage on the TEMPSSENS pad, corresponding to the junction temperature of the die.

# MAX3905 Evaluation Kit

Evaluates: MAX3905

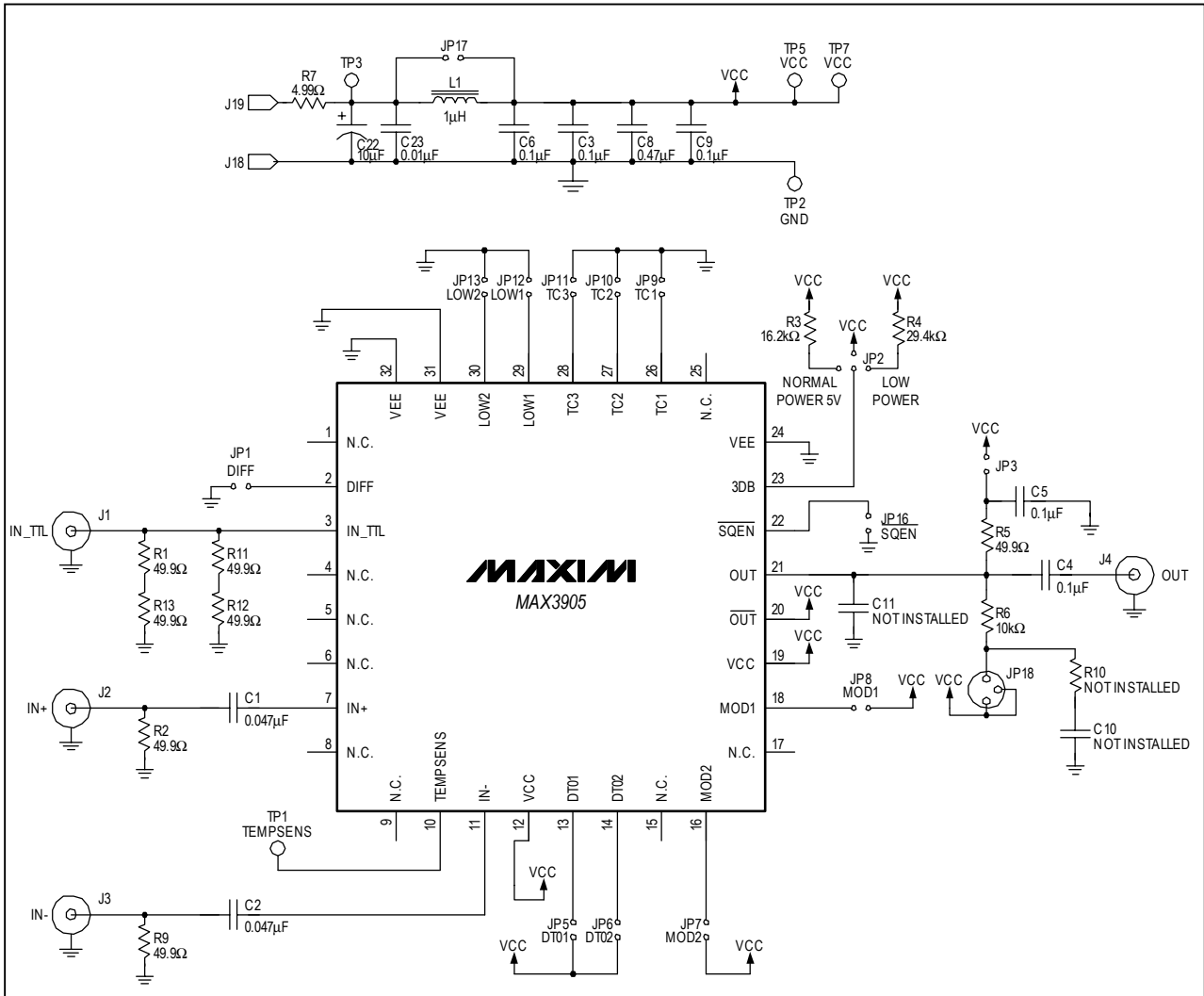

Figure 1. MAX3905 EV Kit Schematic

# MAX3905 Evaluation Kit

Evaluates: MAX3905

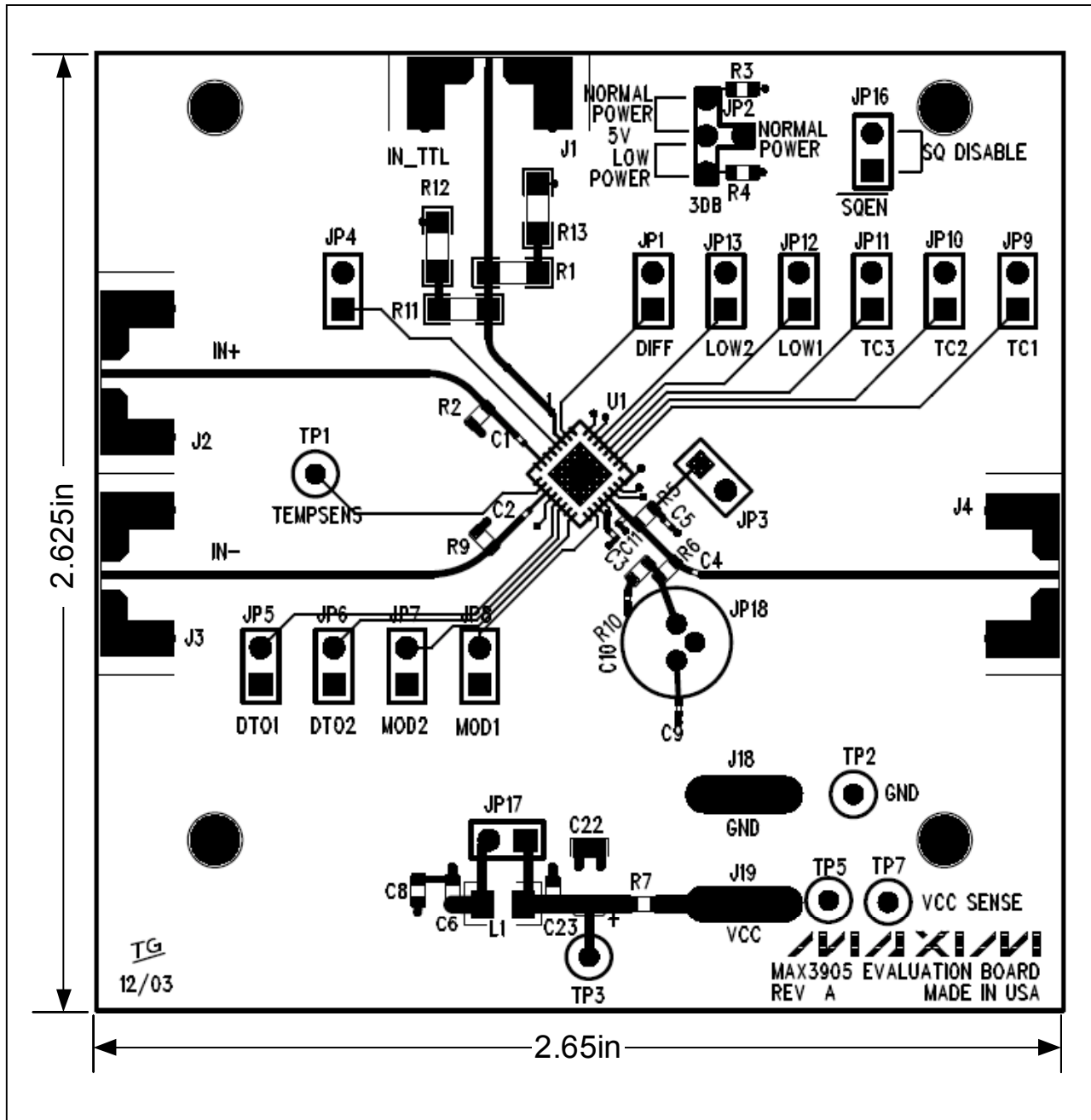

Figure 2. MAX3905 EV Kit Component Placement Guide – Component Side

# MAX3905 Evaluation Kit

Evaluates: MAX3905

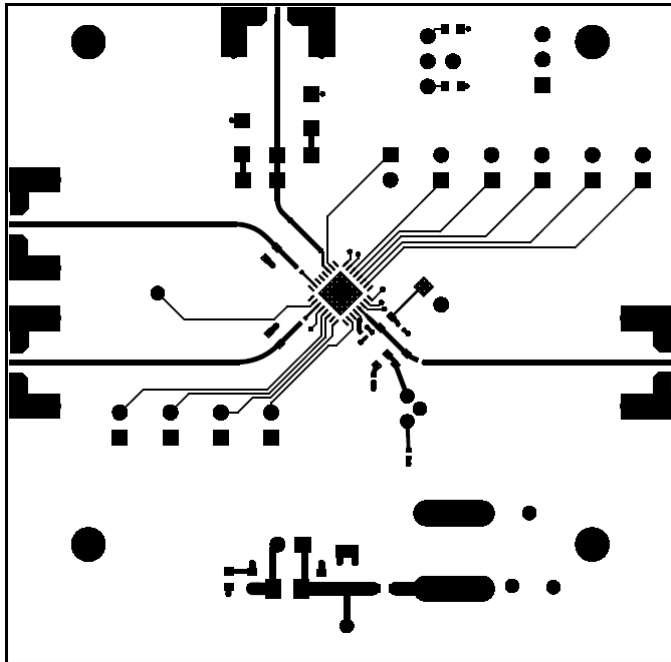

Figure 3. MAX3905 EV Kit PC Board Layout – Component Side

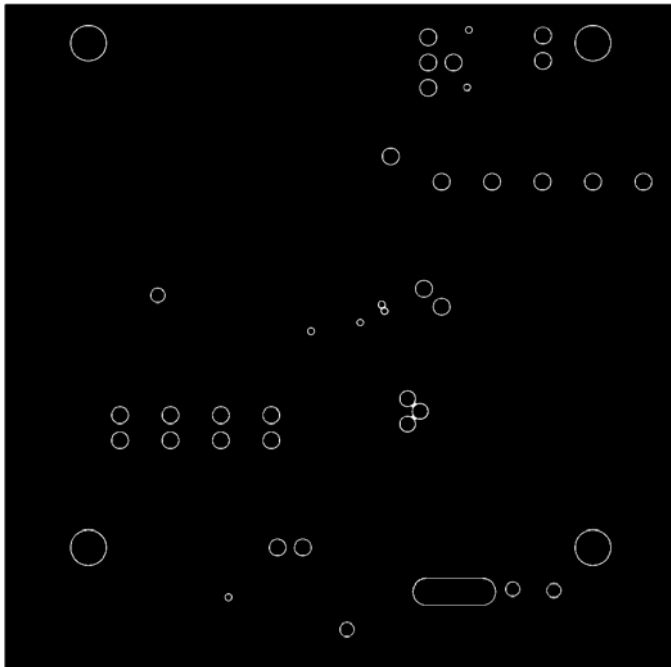

Figure 4. MAX3905 EV Kit PC Board Layout – Ground Plane

# MAX3905 Evaluation Kit

Evaluates: MAX3905

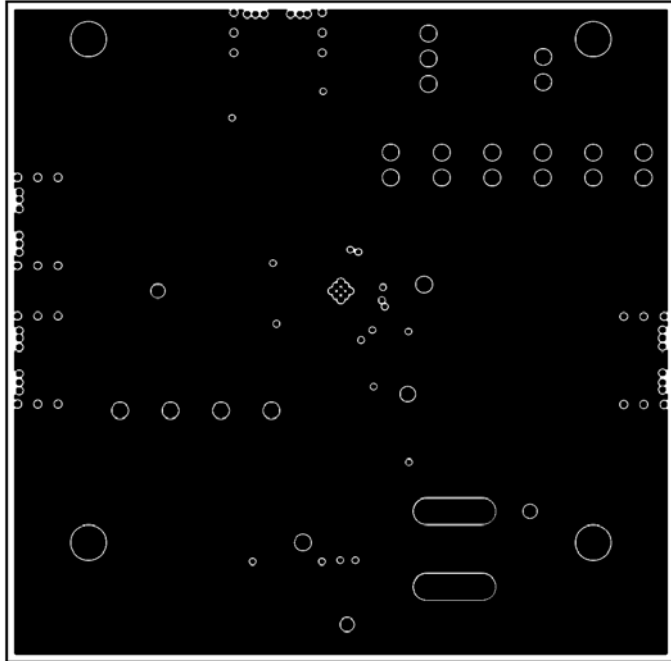

Figure 5. MAX3905 EV Kit PC Board Layout – Power Plane

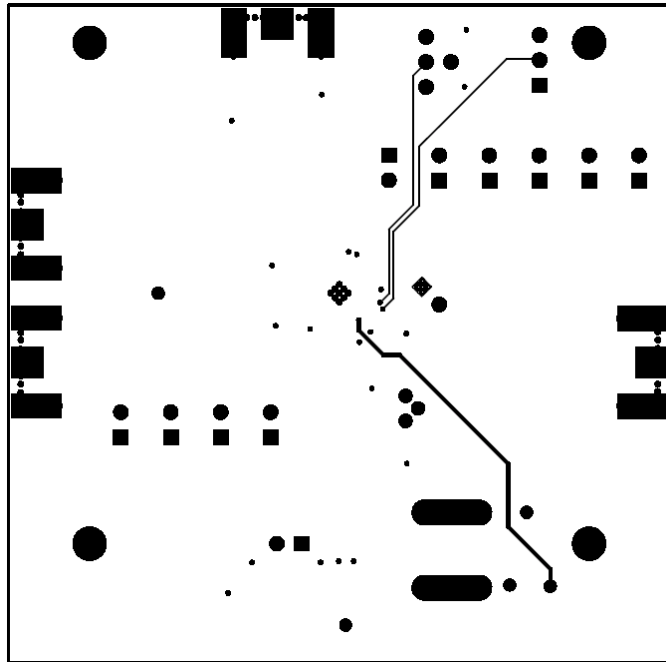

Figure 6. MAX3905 EV Kit PC Board Layout – Solder Side

Maxim cannot assume responsibility for use of any circuitry other than circuitry entirely embodied in a Maxim product. No circuit patent licenses are implied. Maxim reserves the right to change the circuitry and specifications without notice at any time.

6 \_\_\_\_\_ Maxim Integrated Products, 120 San Gabriel Drive, Sunnyvale, CA 94086 408-737-7600