

APT6030BNR 600V 23.0A 0.30Ω
APT6033BNR 600V 22.0A 0.33Ω

POWER MOS IV®

AVALANCHE RATED

N-CHANNEL ENHANCEMENT MODE HIGH VOLTAGE POWER MOSFETS

MAXIMUM RATINGS

All Ratings: $T_C = 25^\circ\text{C}$ unless otherwise specified.

Symbol	Parameter	APT6030BNR	APT6033BNR	UNIT
V_{DSS}	Drain-Source Voltage	600	600	Volts
I_D	Continuous Drain Current @ $T_C = 25^\circ\text{C}$	23	22	Amps
I_{DM}	Pulsed Drain Current ①	92	88	
V_{GS}	Gate-Source Voltage Continuous	±20		Volts
V_{GSM}	Gate-Source Voltage Transient	±30		
P_D	Total Power Dissipation @ $T_C = 25^\circ\text{C}$	360		Watts
	Linear Derating Factor	2.9		W/°C
T_J, T_{STG}	Operating and Storage Junction Temperature Range	-55 to 150		°C
T_L	Lead Temperature: 0.063" from Case for 10 Sec.	300		
I_{AR}	Avalanche Current ① (Repetitive and Non-Repetitive)	23		Amps
E_{AR}	Repetitive Avalanche Energy ①	30		mJ
E_{AS}	Single Pulse Avalanche Energy ④	1300		

STATIC ELECTRICAL CHARACTERISTICS

Symbol	Characteristic / Test Conditions / Part Number	MIN	TYP	MAX	UNIT
BV_{DSS}	Drain-Source Breakdown Voltage ($V_{GS} = 0V, I_D = 250 \mu\text{A}$)	600			Volts
$I_D(\text{ON})$	On State Drain Current ② ($V_{DS} > I_D(\text{ON}) \times R_{DS}(\text{ON})$ Max, $V_{GS} = 10V$)	APT6030BNR	23		Amps
		APT6033BNR	22		
$R_{DS}(\text{ON})$	Drain-Source On-State Resistance ② ($V_{GS} = 10V, 0.5 I_D[\text{Cont.}]$)	APT6030BNR		0.30	Ohms
		APT6033BNR		0.33	
I_{DSS}	Zero Gate Voltage Drain Current ($V_{DS} = V_{DSS}, V_{GS} = 0V$)			250	μA
	Zero Gate Voltage Drain Current ($V_{DS} = 0.8 V_{DSS}, V_{GS} = 0V, T_C = 125^\circ\text{C}$)			1000	
I_{GSS}	Gate-Source Leakage Current ($V_{GS} = \pm 20V, V_{DS} = 0V$)			±100	nA
$V_{GS}(\text{TH})$	Gate Threshold Voltage ($V_{DS} = V_{GS}, I_D = 1.0\text{mA}$)	2		4	Volts

THERMAL CHARACTERISTICS

Symbol	Characteristic	MIN	TYP	MAX	UNIT
$R_{\theta JC}$	Junction to Case			0.34	°C/W
$R_{\theta JA}$	Junction to Ambient			40	

CAUTION: These Devices are Sensitive to Electrostatic Discharge. Proper Handling Procedures Should Be Followed.

USA
405 S.W. Columbia Street

Bend, Oregon 97702-1035 Phone: (503) 382-8028 FAX: (503) 388-0364

EUROPE

Avenue J.F. Kennedy Bât B4 Parc Cadéra Nord F-33700 Merignac - France

Phone: (33) 56 34 34 71 FAX: (33) 56 47 97 61

Page 108

050-6052 Rev B

DYNAMIC CHARACTERISTICS

APT6030/6033BNR

Symbol	Characteristic	Test Conditions	MIN	TYP	MAX	UNIT
C_{iss}	Input Capacitance	$V_{GS} = 0V$ $V_{DS} = 25V$ $f = 1\text{ MHz}$		4270	5120	pF
C_{oss}	Output Capacitance			527	740	
C_{rss}	Reverse Transfer Capacitance			190	285	
Q_g	Total Gate Charge ^③	$V_{GS} = 10V$ $V_{DD} = 0.5 V_{DSS}$ $I_D = I_D [\text{Cont.}] @ 25^\circ\text{C}$		180	270	nC
Q_{gs}	Gate-Source Charge			18	27	
Q_{gd}	Gate-Drain ("Miller") Charge			81	120	
$t_{d(on)}$	Turn-on Delay Time	$V_{GS} = 15V$ $V_{DD} = 0.5 V_{DSS}$ $I_D = I_D [\text{Cont.}] @ 25^\circ\text{C}$ $R_G = 1.8\Omega$		15	30	ns
t_r	Rise Time			35	70	
$t_{d(off)}$	Turn-off Delay Time			122	180	
t_f	Fall Time			60	120	

SOURCE-DRAIN DIODE RATINGS AND CHARACTERISTICS

Symbol	Characteristic / Test Conditions / Part Number	MIN	TYP	MAX	UNIT
I_S	Continuous Source Current (Body Diode)	APT6030BNR		23	Amps
		APT6033BNR		22	
I_{SM}	Pulsed Source Current ^① (Body Diode)	APT6030BNR		92	Amps
		APT6033BNR		88	
V_{SD}	Diode Forward Voltage ^② ($V_{GS} = 0V, I_S = -I_D [\text{Cont.}]$)			1.3	Volts
t_{rr}	Reverse Recovery Time ($I_S = -I_D [\text{Cont.}], di_S/dt = 100A/\mu s$)		584	1168	ns
Q_{rr}	Reverse Recovery Charge ($I_S = -I_D [\text{Cont.}], di_S/dt = 100A/\mu s$)		13	20	μC

SAFE OPERATING AREA CHARACTERISTICS

Symbol	Characteristic	Test Conditions / Part Number	MIN	TYP	MAX	UNIT
SOA1	Safe Operating Area	$V_{DS} = 0.4 V_{DSS}, I_{DS} = P_D / 0.4 V_{DSS}, t = 1\text{ Sec.}$	360			Watts
SOA2	Safe Operating Area	$I_{DS} = I_D [\text{Cont.}], V_{DS} = P_D / I_D [\text{Cont.}], t = 1\text{ Sec.}$	360			
I_{LM}	Inductive Current Clamped	APT6030BNR	92			Amps
		APT6033BNR	88			

① Repetitive Rating: Pulse width limited by maximum junction temperature.

② Pulse Test: Pulse width < 380 μs , Duty Cycle < 2%

③ See MIL-STD-750 Method 3471

④ Starting $T_J = +25^\circ\text{C}$, $L = 4.9\text{mH}$, $R_G = 25\Omega$, Peak $I_L = 23\text{A}$

APT Reserves the right to change, without notice, the specifications and information contained herein.

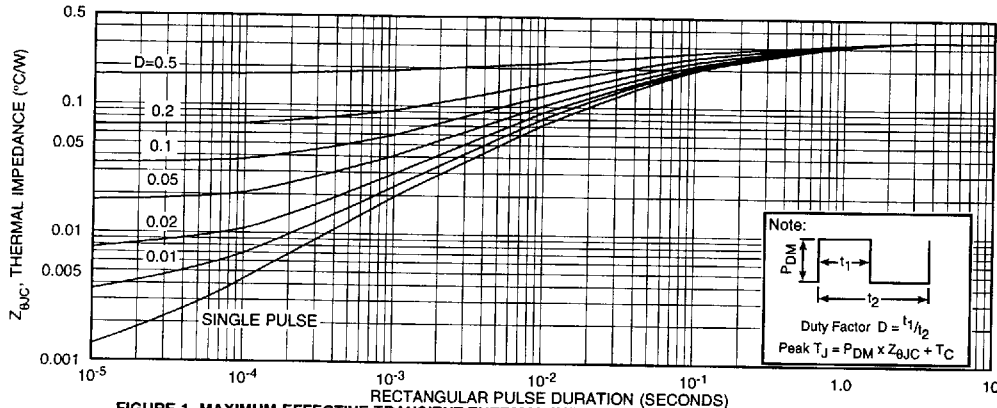

FIGURE 1, MAXIMUM EFFECTIVE TRANSIENT THERMAL IMPEDANCE, JUNCTION-TO-CASE vs PULSE DURATION

APT6030/6033BNR

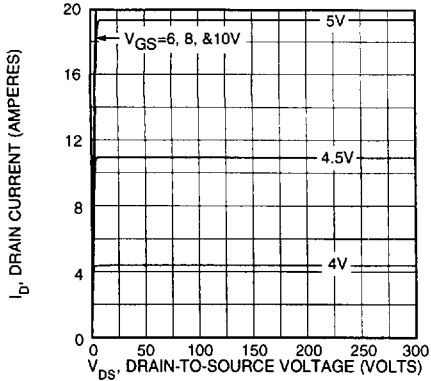

FIGURE 2, TYPICAL OUTPUT CHARACTERISTICS

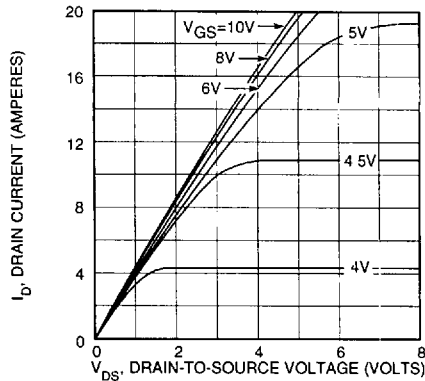

FIGURE 3, TYPICAL OUTPUT CHARACTERISTICS

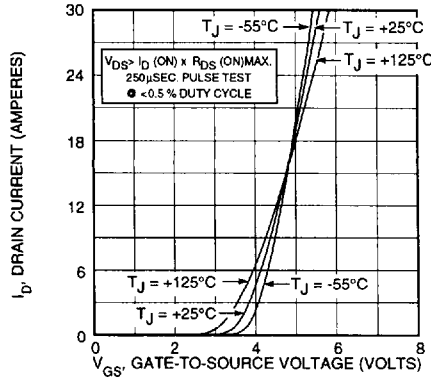

FIGURE 4, TYPICAL TRANSFER CHARACTERISTICS

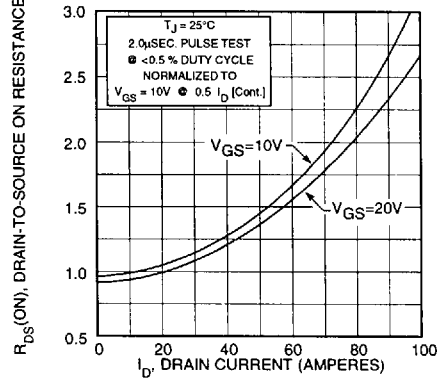

FIGURE 5, R_DS(ON) vs DRAIN CURRENT

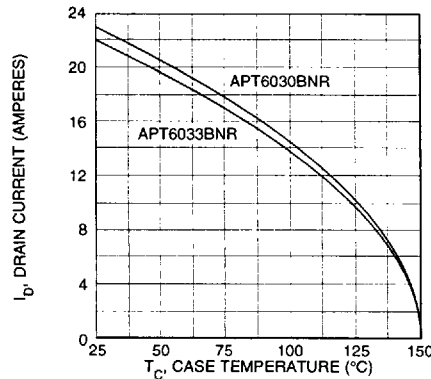

FIGURE 6, MAXIMUM DRAIN CURRENT vs CASE TEMPERATURE

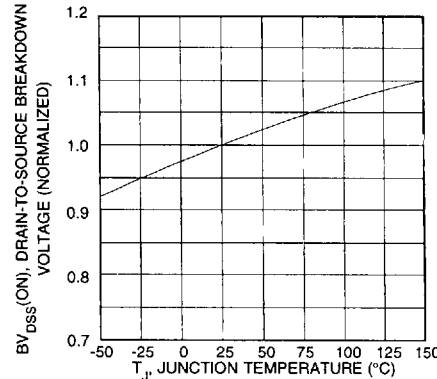

FIGURE 7, BREAKDOWN VOLTAGE vs TEMPERATURE

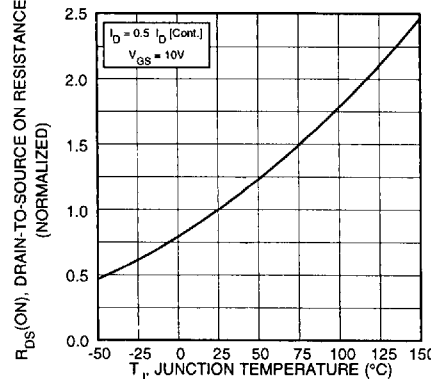

FIGURE 8, ON-RESISTANCE vs. TEMPERATURE

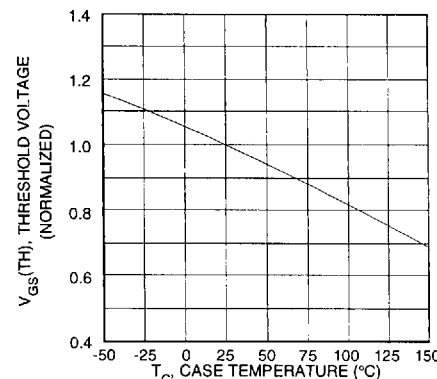

FIGURE 9, THRESHOLD VOLTAGE vs TEMPERATURE

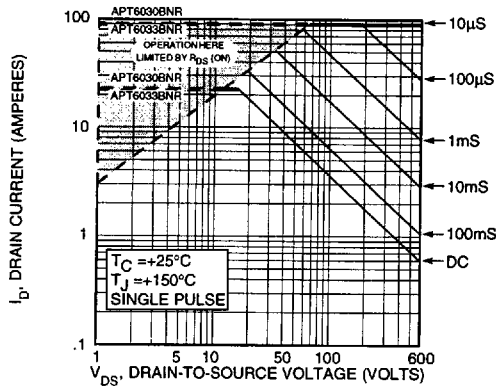

FIGURE 10, MAXIMUM SAFE OPERATING AREA

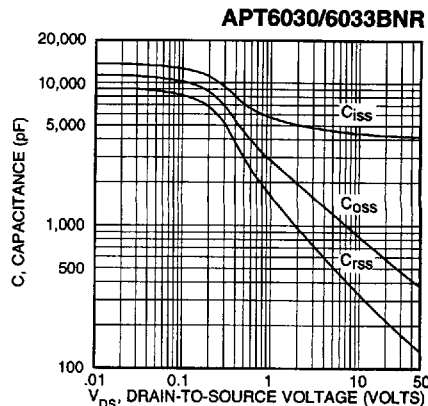

FIGURE 11, TYPICAL CAPACITANCE vs DRAIN-TO-SOURCE VOLTAGE

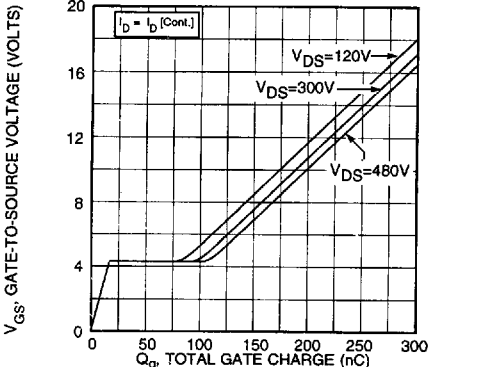

FIGURE 12, GATE CHARGES vs GATE-TO-SOURCE VOLTAGE

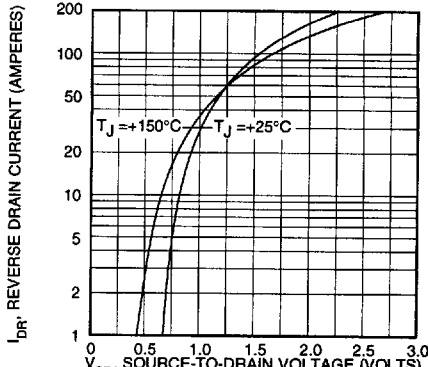
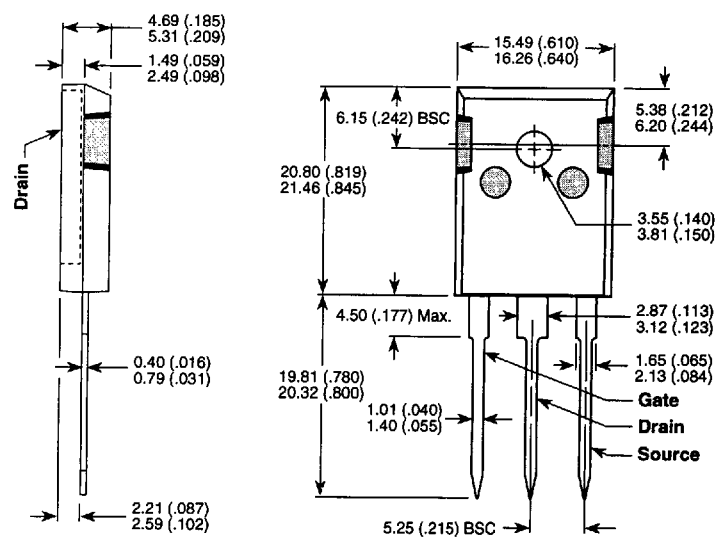

FIGURE 13, TYPICAL SOURCE-DRAIN DIODE FORWARD VOLTAGE

TO-247AD Package Outline



Dimensions in Millimeters and (Inches)
Page 111

050-6052 Rev B