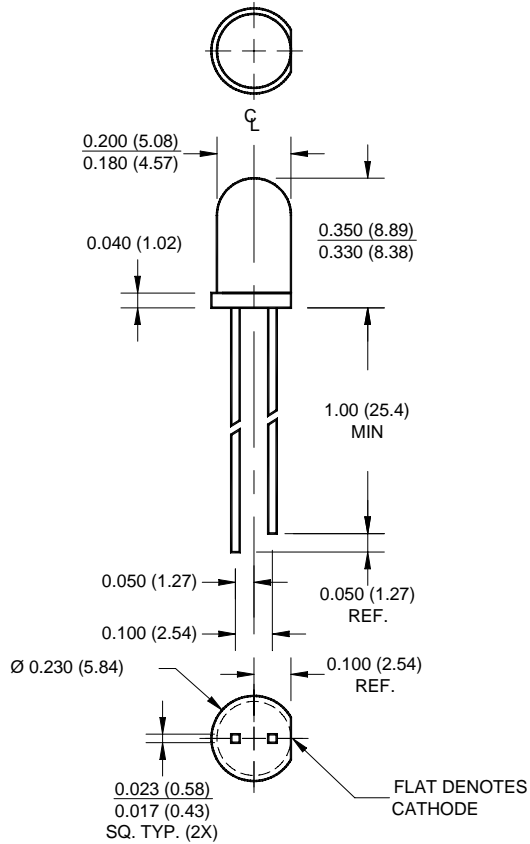


# SUPER BRIGHT T-1 3/4 (5 mm) LED LAMP - Water Clear

## PACKAGE DIMENSIONS



### NOTES:

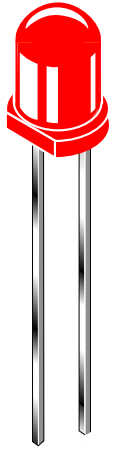
1. Dimensions for all drawings are in inches (mm).
2. Lead spacing is measured where the leads emerge from the package.
3. Protruded resin under the flange is 1.5 mm (0.059") max.

**SUPER RED**  
**MV8031 MV8032**  
**MV8033**

**MV803X**

## FEATURES

- Popular T-1 3/4 package
- Super high brightness suitable for outdoor applications
- Solid state reliability
- Water clear optics
- Standard 100 mil. lead spacing



## DESCRIPTION

This T-1 3/4 super bright LED has a moderate viewing angle of 30° for concentrated light output. The MV803X series is made with an AlInGaP LED that emits red light at 640 nm. It is encapsulated in a water clear epoxy lens package.

## ABSOLUTE MAXIMUM RATINGS (T<sub>A</sub> = 25°C unless otherwise specified)

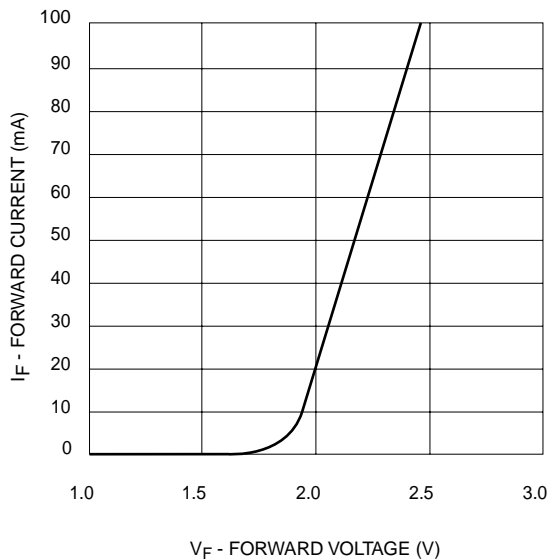
Parameter	Symbol	Rating	Unit
Operating Temperature	T <sub>OPR</sub>	-40 to +100	°C
Storage Temperature	T <sub>STG</sub>	-40 to +100	°C
Lead Soldering Time	T <sub>SOL</sub>	260 for 5 sec	°C
Continuous Forward Current	I <sub>F</sub>	30	mA
Peak Forward Current (f = 1.0 KHz, Duty Factor = 1/10)	I <sub>F</sub>	160	mA
Reverse Voltage	V <sub>R</sub>	5	V
Power Dissipation	P <sub>D</sub>	85	mW

<b>SUPER RED</b>	<b>MV803X</b>
<b>MV8031 MV8032</b>	
<b>MV8033</b>	

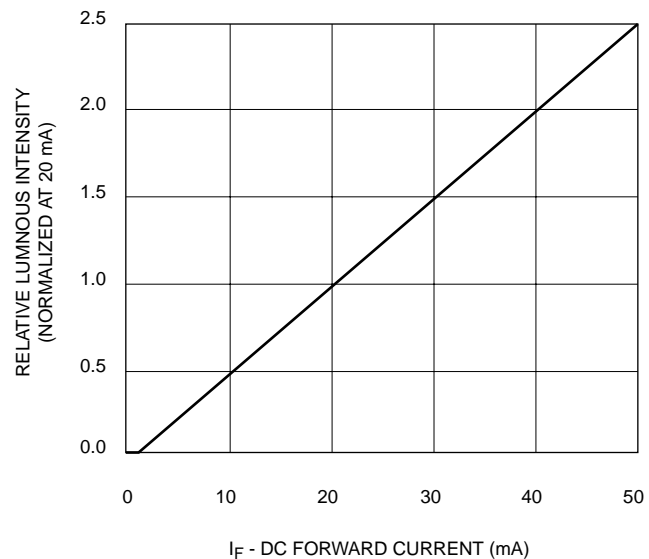
## ELECTRICAL / OPTICAL CHARACTERISTICS (T<sub>A</sub> =25°C)

Part Number	MV8031	MV8032	MV8033	Condition
Luminous Intensity (mcd)				I <sub>F</sub> = 20mA
Minimum	400	630	1000	
Typical	600	940	1500	
Forward Voltage (V)				I <sub>F</sub> = 20mA
Maximum	2.8	2.8	2.8	
Typical	2.1	2.1	2.1	
Peak Wavelength (nm)	640	640	640	I <sub>F</sub> = 20mA
Spectral Line Half Width (nm)	20	20	20	I <sub>F</sub> = 20mA
Viewing Angle (°)	30	30	30	I <sub>F</sub> = 20mA

## TYPICAL PERFORMANCE CURVES



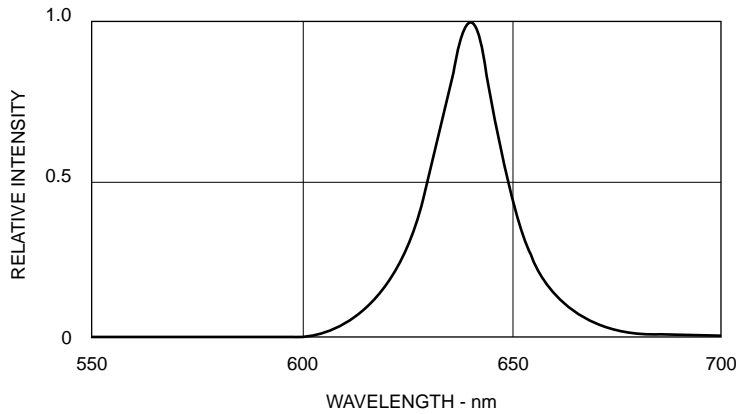
**Fig. 1 Forward Current vs. Forward Voltage**



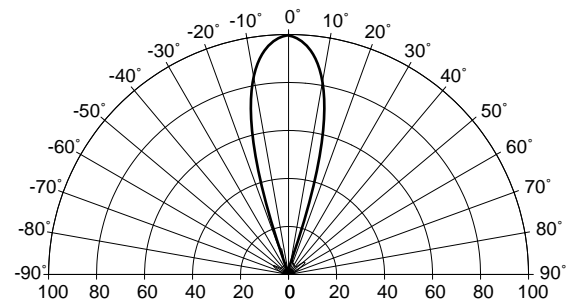
**Fig. 2 Relative Luminous Intensity vs. DC Forward Current**

# SUPER BRIGHT T-1 3/4 (5 mm) LED LAMP - Water Clear

<b>SUPER RED</b>	<b>MV803X</b>
<b>MV8031 MV8032</b>	
<b>MV8033</b>	

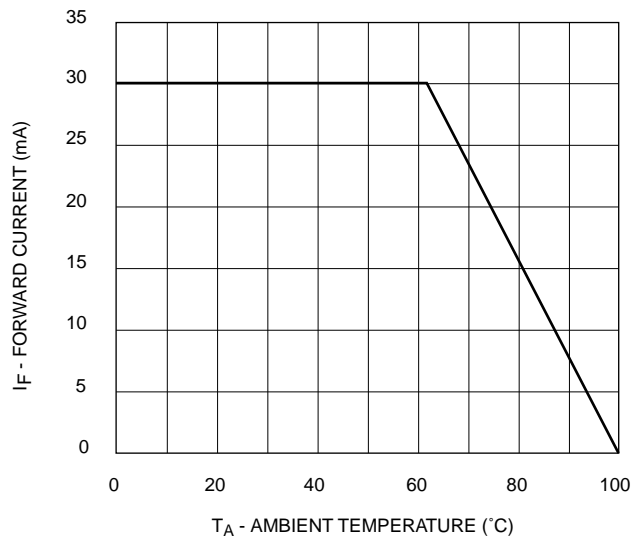


**Fig. 3 Relative Intensity vs Peak Wavelength**



REL. LUMINOUS INTENSITY (%)

**Fig. 4 Radiation Diagram**



**Fig. 5 Current Derating Curve**

## DISCLAIMER

FAIRCHILD SEMICONDUCTOR RESERVES THE RIGHT TO MAKE CHANGES WITHOUT FURTHER NOTICE TO ANY PRODUCTS HEREIN TO IMPROVE RELIABILITY, FUNCTION OR DESIGN. FAIRCHILD DOES NOT ASSUME ANY LIABILITY ARISING OUT OF THE APPLICATION OR USE OF ANY PRODUCT OR CIRCUIT DESCRIBED HEREIN; NEITHER DOES IT CONVEY ANY LICENSE UNDER ITS PATENT RIGHTS, NOR THE RIGHTS OF OTHERS.

## LIFE SUPPORT POLICY

FAIRCHILD'S PRODUCTS ARE NOT AUTHORIZED FOR USE AS CRITICAL COMPONENTS IN LIFE SUPPORT DEVICES OR SYSTEMS WITHOUT THE EXPRESS WRITTEN APPROVAL OF THE PRESIDENT OF FAIRCHILD SEMICONDUCTOR CORPORATION. As used herein:

1. Life support devices or systems are devices or systems which, (a) are intended for surgical implant into the body, or (b) support or sustain life, and (c) whose failure to perform when properly used in accordance with instructions for use provided in the labeling, can be reasonably expected to result in a significant injury of the user.
2. A critical component in any component of a life support device or system whose failure to perform can be reasonably expected to cause the failure of the life support device or system, or to affect its safety or effectiveness.