

JFETs Switching

N-Channel — Depletion

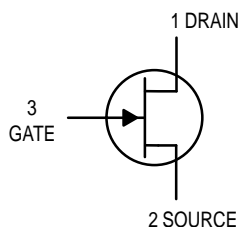

MPF4392
MPF4393

Motorola Preferred Devices

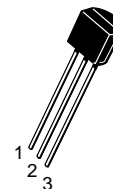

CASE 29-04, STYLE 5
TO-92 (TO-226AA)

MAXIMUM RATINGS

Rating	Symbol	Value	Unit
Drain-Source Voltage	V_{DS}	30	Vdc
Drain-Gate Voltage	V_{DG}	30	Vdc
Gate-Source Voltage	V_{GS}	30	Vdc
Forward Gate Current	$I_{G(f)}$	50	mAdc
Total Device Dissipation @ $T_A = 25^\circ\text{C}$ Derate above 25°C	P_D	350 2.8	mW mW/ $^\circ\text{C}$
Operating and Storage Channel Temperature Range	T_{channel} , T_{stg}	-65 to +150	$^\circ\text{C}$

ELECTRICAL CHARACTERISTICS ($T_A = 25^\circ\text{C}$ unless otherwise noted)

Characteristic	Symbol	Min	Typ	Max	Unit
----------------	--------	-----	-----	-----	------

OFF CHARACTERISTICS

Gate-Source Breakdown Voltage ($I_G = 1.0 \mu\text{Adc}$, $V_{DS} = 0$)	$V_{(BR)GSS}$	30	—	—	Vdc
Gate Reverse Current ($V_{GS} = 15 \text{ Vdc}$, $V_{DS} = 0$) ($V_{GS} = 15 \text{ Vdc}$, $V_{DS} = 0$, $T_A = 100^\circ\text{C}$)	I_{GSS}	— —	— —	1.0 0.2	nAdc μAdc
Drain-Cutoff Current ($V_{DS} = 15 \text{ Vdc}$, $V_{GS} = 12 \text{ Vdc}$) ($V_{DS} = 15 \text{ Vdc}$, $V_{GS} = 12 \text{ Vdc}$, $T_A = 100^\circ\text{C}$)	$I_{D(off)}$	— —	— —	1.0 0.1	nAdc μAdc
Gate-Source Voltage ($V_{DS} = 15 \text{ Vdc}$, $I_D = 10 \text{ nAdc}$)	V_{GS}	-2.0 -0.5	— —	-5.0 -3.0	Vdc

ON CHARACTERISTICS

Zero-Gate-Voltage Drain Current ⁽¹⁾ ($V_{DS} = 15 \text{ Vdc}$, $V_{GS} = 0$)	I_{DSS}	MPF4392 MPF4393	25 5.0	— —	75 30	mAdc
Drain-Source On-Voltage ($I_D = 6.0 \text{ mAdc}$, $V_{GS} = 0$) ($I_D = 3.0 \text{ mAdc}$, $V_{GS} = 0$)	$V_{DS(on)}$	MPF4392 MPF4393	— —	— —	0.4 0.4	Vdc
Static Drain-Source On Resistance ($I_D = 1.0 \text{ mAdc}$, $V_{GS} = 0$)	$r_{DS(on)}$	MPF4392 MPF4393	— —	— —	60 100	Ω

SMALL-SIGNAL CHARACTERISTICS

Forward Transfer Admittance ($V_{DS} = 15 \text{ Vdc}$, $I_D = 25 \text{ mAdc}$, $f = 1.0 \text{ kHz}$) ($V_{DS} = 15 \text{ Vdc}$, $I_D = 5.0 \text{ mAdc}$, $f = 1.0 \text{ kHz}$)	$ y_{fs} $	MPF4392 MPF4393	— —	17 12	— —	mmhos
--	------------	--------------------	--------	----------	--------	-------

1. Pulse Test: Pulse Width $\leq 300 \mu\text{s}$, Duty Cycle $\leq 3.0\%$.

Preferred devices are Motorola recommended choices for future use and best overall value.

REV 1

MPF4392 MPF4393

ELECTRICAL CHARACTERISTICS (T_A = 25°C unless otherwise noted) (Continued)

Characteristic	Symbol	Min	Typ	Max	Unit
SMALL-SIGNAL CHARACTERISTICS (continued)					
Drain-Source "ON" Resistance (V _{GS} = 0, I _D = 0, f = 1.0 kHz)	r _{ds(on)}	—	—	60	Ω
	MPF4392	—	—	100	
	MPF4393	—	—	—	
Input Capacitance (V _{GS} = 15 Vdc, V _{DS} = 0, f = 1.0 MHz)	C _{iss}	—	6.0	10	pF
Reverse Transfer Capacitance (V _{GS} = 12 Vdc, V _{DS} = 0, f = 1.0 MHz) (V _{DS} = 15 Vdc, I _D = 10 mAdc, f = 1.0 MHz)	C _{rss}	—	2.5 3.2	3.5	pF

SWITCHING CHARACTERISTICS

Rise Time (See Figure 2) (I _{D(on)} = 6.0 mAdc) (I _{D(on)} = 3.0 mAdc)	t _r	—	2.0 2.5	5.0 5.0	ns
	MPF4392	—	—	—	
	MPF4393	—	—	—	
Fall Time (See Figure 4) (V _{GS(off)} = 7.0 Vdc) (V _{GS(off)} = 5.0 Vdc)	t _f	—	15 29	20 35	ns
	MPF4392	—	—	—	
	MPF4393	—	—	—	
Turn-On Time (See Figures 1 and 2) (I _{D(on)} = 6.0 mAdc) (I _{D(on)} = 3.0 mAdc)	t _{on}	—	4.0 6.5	15 15	ns
	MPF4392	—	—	—	
	MPF4393	—	—	—	
Turn-Off Time (See Figures 3 and 4) (V _{GS(off)} = 7.0 Vdc) (V _{GS(off)} = 5.0 Vdc)	t _{off}	—	20 37	35 55	ns
	MPF4392	—	—	—	
	MPF4393	—	—	—	

TYPICAL SWITCHING CHARACTERISTICS

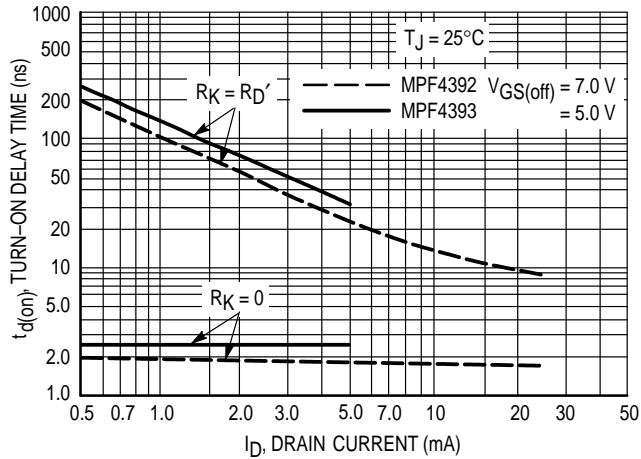

Figure 1. Turn-On Delay Time

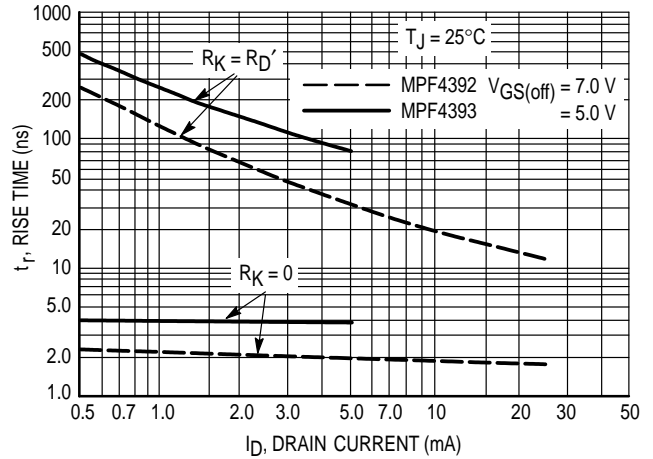

Figure 2. Rise Time

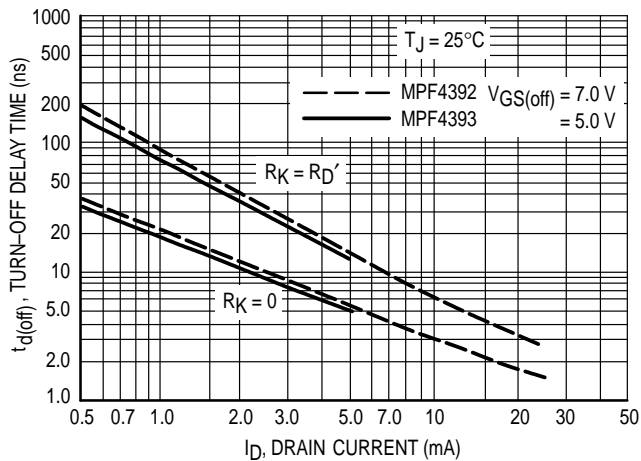

Figure 3. Turn-Off Delay Time

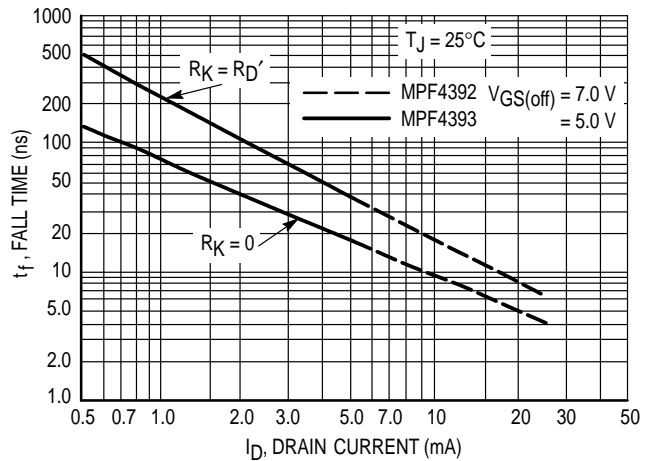

Figure 4. Fall Time

NOTE 1

The switching characteristics shown above were measured using a test circuit similar to Figure 5. At the beginning of the switching interval, the gate voltage is at Gate Supply Voltage ($-V_{GG}$). The Drain-Source Voltage (V_{DS}) is slightly lower than Drain Supply Voltage (V_{DD}) due to the voltage divider. Thus Reverse Transfer Capacitance (C_{RSS}) or Gate-Drain Capacitance (C_{gd}) is charged to $V_{GG} + V_{DS}$.

During the turn-on interval, Gate-Source Capacitance (C_{gs}) discharges through the series combination of R_{GEN} and R_K . C_{gd} must discharge to $V_{DS(on)}$ through R_G and R_K in series with the parallel combination of effective load impedance (R'_D) and Drain-Source Resistance (r_{ds}). During the turn-off, this charge flow is reversed.

Predicting turn-on time is somewhat difficult as the channel resistance r_{ds} is a function of the gate-source voltage. While C_{gs} discharges, V_{GS} approaches zero and r_{ds} decreases. Since C_{gd} discharges through r_{ds} , turn-on time is non-linear. During turn-off, the situation is reversed with r_{ds} increasing as C_{gd} charges.

The above switching curves show two impedance conditions: 1) R_K is equal to R'_D which simulates the switching behavior of cascaded stages where the driving source impedance is normally the load impedance of the previous stage, and 2) $R_K = 0$ (low impedance) the driving source impedance is that of the generator.

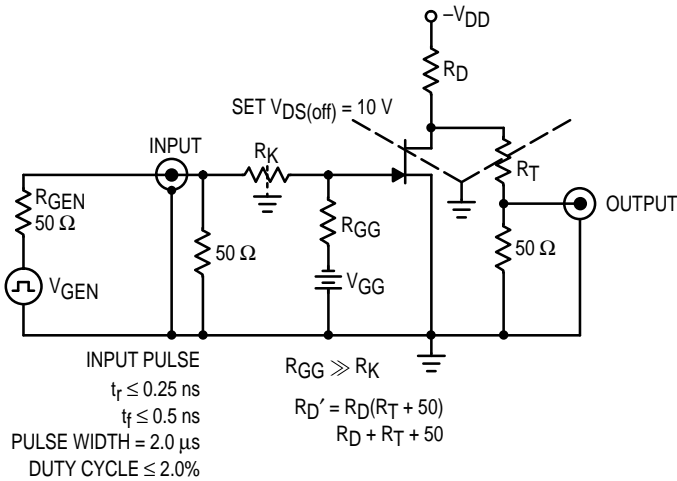

Figure 5. Switching Time Test Circuit

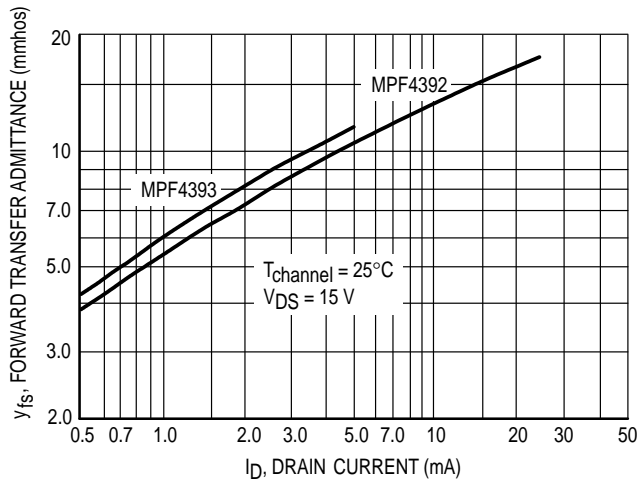

Figure 6. Typical Forward Transfer Admittance

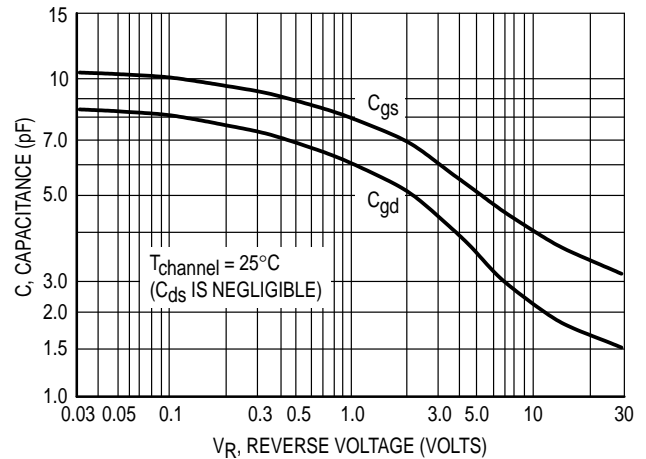

Figure 7. Typical Capacitance

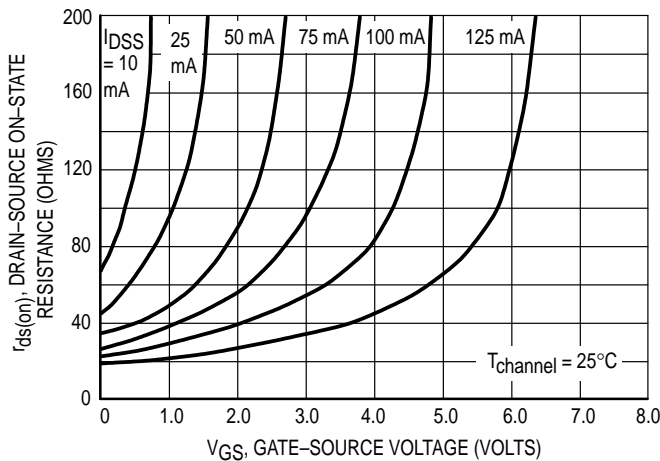

Figure 8. Effect of Gate-Source Voltage On Drain-Source Resistance

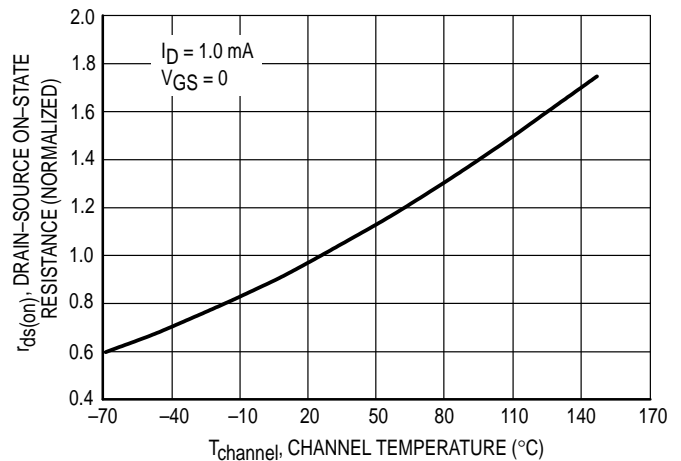

Figure 9. Effect of Temperature On Drain-Source On-State Resistance

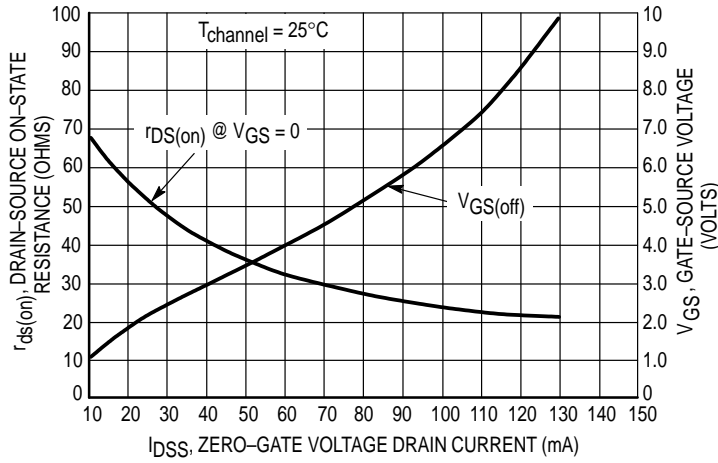

Figure 10. Effect of I_{DSS} On Drain-Source Resistance and Gate-Source Voltage

NOTE 2

The Zero-Gate-Voltage Drain Current (I_{DSS}), is the principle determinant of other J-FET characteristics. Figure 10 shows the relationship of Gate-Source Off Voltage ($V_{GS(off)}$) and Drain-Source On Resistance ($r_{ds(on)}$) to I_{DSS} . Most of the devices will be within $\pm 10\%$ of the values shown in Figure 10. This data will be useful in predicting the characteristic variations for a given part number.

For example:

Unknown

$r_{ds(on)}$ and V_{GS} range for an MPF4392

The electrical characteristics table indicates that an MPF4392 has an I_{DSS} range of 25 to 75 mA. Figure 10 shows $r_{ds(on)} = 52$ Ohms for $I_{DSS} = 25$ mA and 30 Ohms for $I_{DSS} = 75$ mA. The corresponding V_{GS} values are 2.2 volts and 4.8 volts.

PACKAGE DIMENSIONS

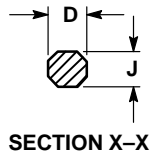
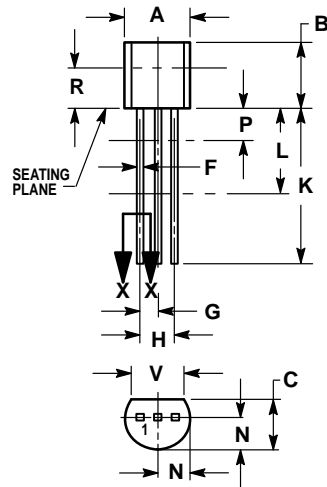

SECTION X-X

**CASE 029-04
(TO-226AA)
ISSUE AD**

NOTES:

1. DIMENSIONING AND TOLERANCING PER ANSI Y14.5M, 1982.
2. CONTROLLING DIMENSION: INCH.
3. CONTOUR OF PACKAGE BEYOND DIMENSION R IS UNCONTROLLED.
4. DIMENSION F APPLIES BETWEEN P AND L. DIMENSION D AND J APPLY BETWEEN L AND K. MINIMUM. LEAD DIMENSION IS UNCONTROLLED IN P AND BEYOND DIMENSION K MINIMUM.

DIM	INCHES		MILLIMETERS	
	MIN	MAX	MIN	MAX
A	0.175	0.205	4.45	5.20
B	0.170	0.210	4.32	5.33
C	0.125	0.165	3.18	4.19
D	0.016	0.022	0.41	0.55
F	0.016	0.019	0.41	0.48
G	0.045	0.055	1.15	1.39
H	0.095	0.105	2.42	2.66
J	0.015	0.020	0.39	0.50
K	0.500	—	12.70	—
L	0.250	—	6.35	—
N	0.080	0.105	2.04	2.66
P	—	0.100	—	2.54
R	0.115	—	2.93	—
V	0.135	—	3.43	—

STYLE 5:

1. DRAIN
2. SOURCE
3. GATE

Motorola reserves the right to make changes without further notice to any products herein. Motorola makes no warranty, representation or guarantee regarding the suitability of its products for any particular purpose, nor does Motorola assume any liability arising out of the application or use of any product or circuit, and specifically disclaims any and all liability, including without limitation consequential or incidental damages. "Typical" parameters which may be provided in Motorola data sheets and/or specifications can and do vary in different applications and actual performance may vary over time. All operating parameters, including "Typicals" must be validated for each customer application by customer's technical experts. Motorola does not convey any license under its patent rights nor the rights of others. Motorola products are not designed, intended, or authorized for use as components in systems intended for surgical implant into the body, or other applications intended to support or sustain life, or for any other application in which the failure of the Motorola product could create a situation where personal injury or death may occur. Should Buyer purchase or use Motorola products for any such unintended or unauthorized application, Buyer shall indemnify and hold Motorola and its officers, employees, subsidiaries, affiliates, and distributors harmless against all claims, costs, damages, and expenses, and reasonable attorney fees arising out of, directly or indirectly, any claim of personal injury or death associated with such unintended or unauthorized use, even if such claim alleges that Motorola was negligent regarding the design or manufacture of the part. Motorola and  are registered trademarks of Motorola, Inc. Motorola, Inc. is an Equal Opportunity/Affirmative Action Employer.

Mfax is a trademark of Motorola, Inc.

How to reach us:

USA/EUROPE/Locations Not Listed: Motorola Literature Distribution;
P.O. Box 5405, Denver, Colorado 80217. 303-675-2140 or 1-800-441-2447

JAPAN: Nippon Motorola Ltd.: SPD, Strategic Planning Office, 4-32-1,
Nishi-Gotanda, Shinagawa-ku, Tokyo 141, Japan. 81-3-5487-8488

Mfax™: RMFAX0@email.sps.mot.com – TOUCHTONE 602-244-6609
– US & Canada ONLY 1-800-774-1848

ASIA/PACIFIC: Motorola Semiconductors H.K. Ltd.; 8B Tai Ping Industrial Park,
51 Ting Kok Road, Tai Po, N.T., Hong Kong. 852-26629298

INTERNET: <http://motorola.com/sps>

