

SINGLE CHANNEL IL250/251/252 DUAL CHANNEL ILD250/251/252 BIDIRECTIONAL INPUT OPTOCOUPLER

FEATURES

- Selected Current Transfer Ratios
20%, 50%, 100% Minimum
- AC or Polarity Insensitive Input
- Built-in Reverse Polarity Input Protection
- Improved CTR Symmetry
- Industry Standard DIP Package
- Underwriters Lab File #E52744
-  VDE 0884 Available with Option 1

Maximum Ratings (Per Channel)

Emitter

Continuous Forward Current 60 mA
Power Dissipation at 25°C 100 mW
Derate Linearly from 25°C 1.33 mW/°C

Detector

Collector-Emitter Breakdown Voltage 30 V
Emitter-Base Breakdown Voltage 5 V
Collector-Base Breakdown Voltage 70 V
Power Dissipation at 25°C

Single Channel 200 mW

Dual Channel 150 mW

Derate Linearly from 25°C

Single Channel 2.6 mW/°C

Dual Channel 2.0 mW/°C

Package

Isolation Test Voltage (between emitter and detector referred to standard climate 23°C/50%RH, DIN 50014) 5300 VAC_{RMS}

Creepage 7 mm min.

Clearance 7 mm min.

Isolation Resistance

$V_{IO}=500V, T_A=25^\circ C$ $10^{12} \Omega$

$V_{IO}=500V, T_A=100^\circ C$ $10^{11} \Omega$

Total Dissipation at 25°C

Single Channel 250 mW

Dual Channel 400 mW

Derate Linearly from 25°C

Single Channel 3.3 mW/°C

Dual Channel 5.3 mW/°C

Storage Temperature -55°C to +150°C

Operating Temperature -55°C to +100°C

Lead Soldering Time at 260°C 10 sec.

Dimensions in inches (mm)

Single Channel

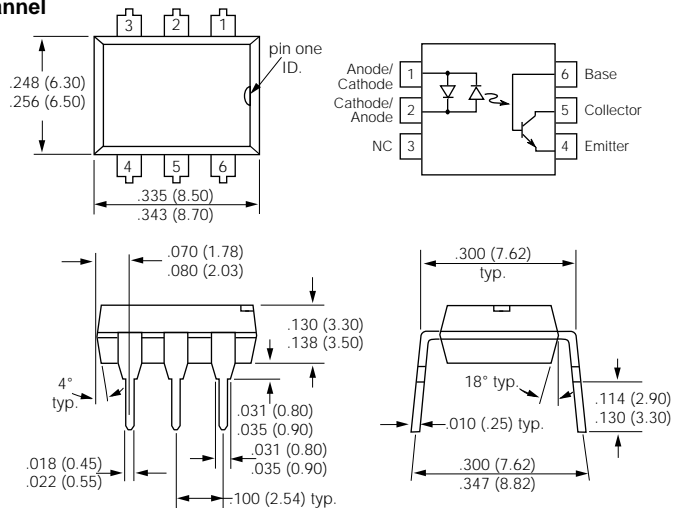

Dual Channel

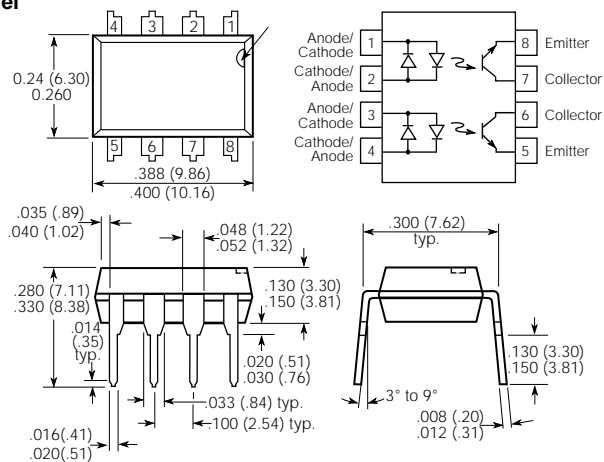

DESCRIPTION

The IL/ILD250/251/252 are bidirectional input optically coupled isolators consisting of two Gallium Arsenide infrared LEDs coupled to a silicon NPN phototransistor per channel.

The IL/ILD250 has a minimum CTR of 50%, the IL/ILD251 has a minimum CTR of 20%, and the IL/ILD252 has a minimum CTR of 100%.

The IL/IL250/1/2 are single channel optocouplers. The ILD250/1/2 has two isolated channels in a single DIP package.

These optocouplers are ideal for applications requiring AC signal detection and monitoring.

Electrical Characteristics ($T_A=25\text{ C}$)

Parameter	Min.	Typ.	Max	Unit	Condition
Emitter					
Forward Voltage V_F		1/2	1.5	V	$I_F=\pm 10\text{ mA}$
Detector					
BV_{CEO}	30	50		V	$I_C=1\text{ mA}$
BV_{EBO}	7	10		V	$I_E=100\text{ }\mu\text{A}$
BV_{CBO}	70	90		V	$I_C=10\text{ }\mu\text{A}$
I_{CEO}		5	50	nA	$V_{CE}=10\text{ V}$
Package					
V_{CEsat}			0.4	V	$I_F=\pm 16\text{ mA}$, $I_C=2\text{ mA}$
DC Current Transfer Ratio				%	$I_F=\pm 10\text{ mA}$, $V_{CE}=10\text{ V}$
IL/D250	50				
IL/D251	20				
IL/D252	100				
Symmetry CTR @ +10 mA CTR @ -10 mA	0.50	1.0	2.0		

Figure 1. LED forward current versus forward voltage

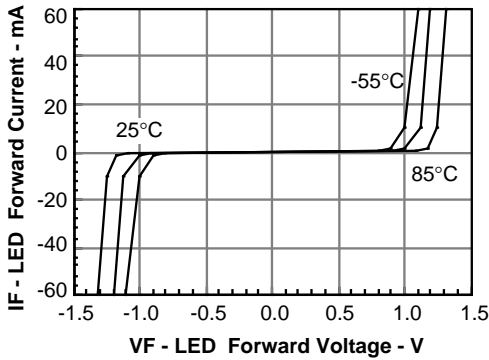

Figure 2. Normalized non-saturated and saturated CTR at $T_A = 25\text{ }^\circ\text{C}$ versus LED current

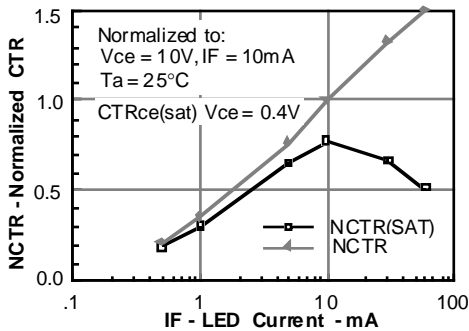

Figure 3. Normalized non-saturated and saturated CTR at $T_A = 50\text{ }^\circ\text{C}$ versus LED current

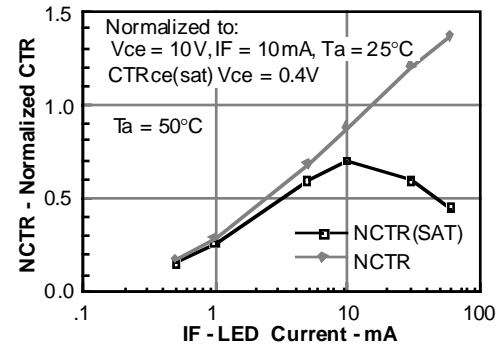

Figure 4. Normalized non-saturated and saturated CTR at $T_A = 70\text{ }^\circ\text{C}$ versus LED current

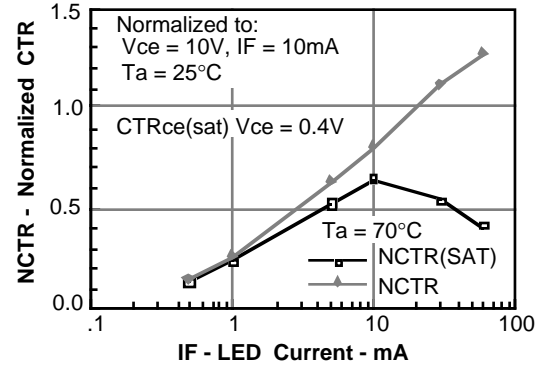

Figure 5. Normalized non-saturated and saturated CTR at $T_A = 85\text{ }^\circ\text{C}$ versus LED current

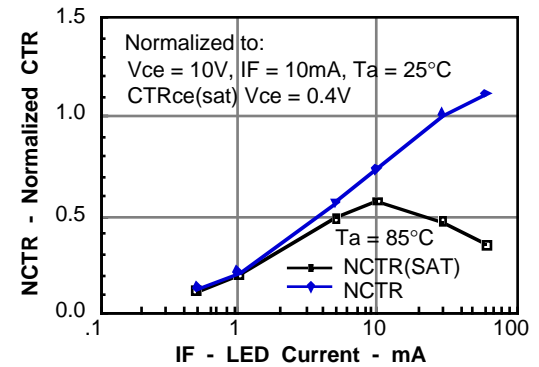

Figure 6. Collector-emitter current versus temperature and LED current

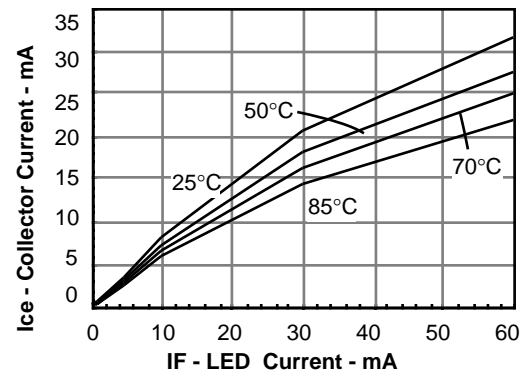

Figure 7. Collector-emitter leakage current versus temperature

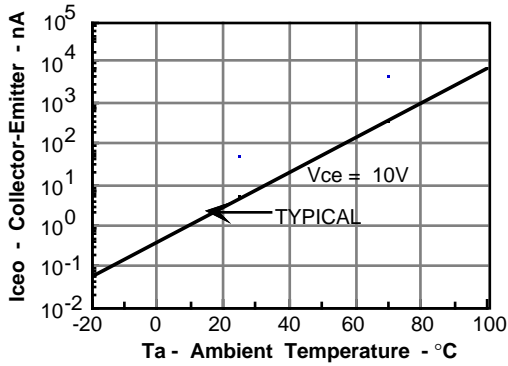

Figure 8. Normalized CTRcb versus LED current and temperature

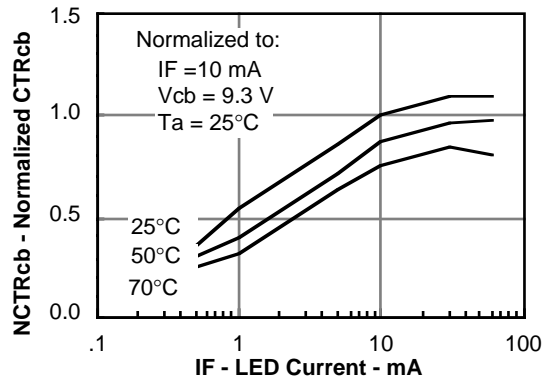

Figure 9. Collector base photocurrent versus LED current

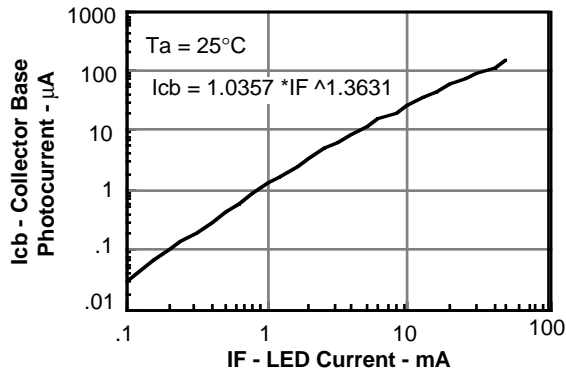

Figure 10. Normalized photocurrent versus If and temperature

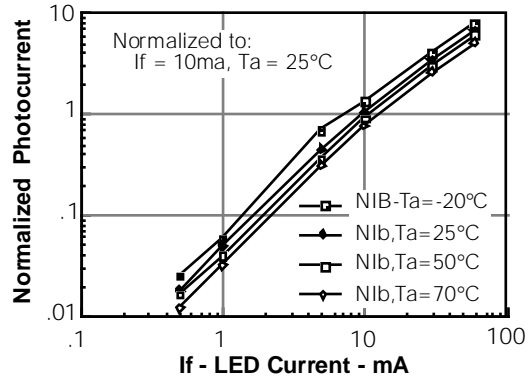

Figure 11. Normalized non-saturated HFE versus base current and temperature

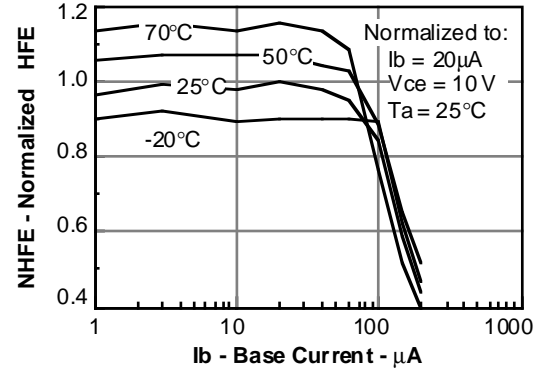

Figure 12. Normalized saturated HFE versus base current and temperature

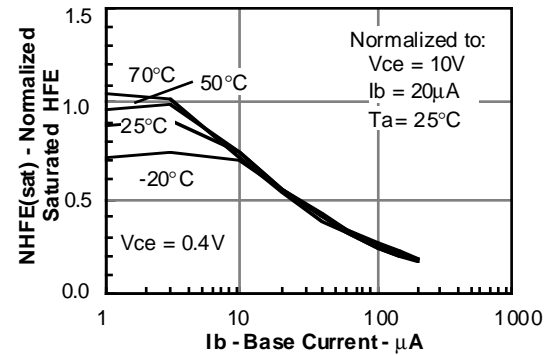

Figure 13. Propagation delay versus collector load resistor

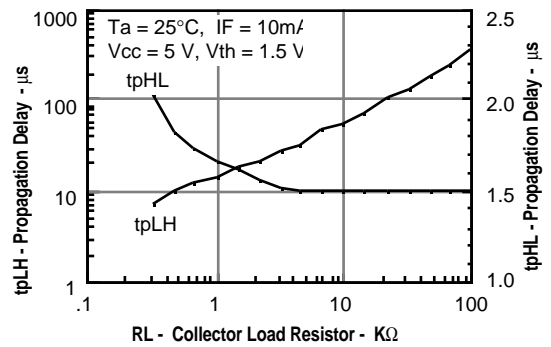

Figure 14. Switching timing and schematic

