

Compact, Intelligent Temperature Controllers

- 1/32 DIN sized controller saves panel space, measures just 100 mm deep
- Accepts thermocouple, platinum RTD, non-contact temperature sensor, and analog temperature inputs
- Auto-tuning and self-tuning available; functions can be used simultaneously
- Heating or heating/cooling control
- Water-resistant construction (NEMA 4X, equivalent to IP66)
- Conforms to UL, CSA, and IEC safety standards as well as CE marking
- 3-year warranty



Ordering Information

Optional communications and event input boards are shown on the following page.

■ STANDARD TEMPERATURE CONTROLLERS

Size	Power supply voltage	Alarm points	Output	Part number	
				Thermocouple input	Platinum RTD input
1/32 DIN 48(W) x 24 (H) x 100(D) mm	100 to 240 VAC	—	Relay	E5GN-RTC AC100-240	E5GN-RP AC100-240
			Voltage (for driving SSR)	E5GN-QTC AC100-240	E5GN-QP AC100-240
		1 (See Note 1)	Relay	E5GN-R1TC AC100-240	E5GN-R1P AC100-240
			Voltage (for driving SSR)	E5GN-Q1TC AC100-240	E5GN-Q1P AC100-240
	24 V AC/DC	—	Relay	E5GN-RTC AC/DC24	E5GN-RP AC/DC24
			Voltage (for driving SSR)	E5GN-QTC AC/DC24	E5GN-QP AC/DC24
		1 (See Note 1)	Relay	E5GN-R1TC AC/DC24	E5GN-R1P AC/DC24
			Voltage (for driving SSR)	E5GN-Q1TC AC/DC24	E5GN-Q1P AC/DC24

Note: 1. If the heating/cooling function is used, ALM1 will be used for control output; the alarm output will not be available.
 2. Control output 2 for heating/cooling control is a relay output

■ TEMPERATURE CONTROLLERS WITH COMMUNICATIONS

Size	Power supply voltage	Communication type	Output	Part number	
				Thermocouple input	Platinum RTD input
1/32 DIN 48(W) x 24 (H) x 100(D) mm	100 to 240 VAC	RS-485	Relay	E5GN-R03TC-FLK AC100-240	E5GN-R03P-FLK AC100-240
			Voltage (for driving SSR)	E5GN-Q03TC-FLK AC100-240	E5GN-Q03P-FLK AC100-240
	24 V AC/DC		Relay	E5GN-R03TC-FLK AC/DC24	E5GN-R03P-FLK AC/DC24
			Voltage (for driving SSR)	E5GN-Q03TC-FLK AC/DC24	E5GN-Q03P-FLK AC/DC24

INPUT RANGES

Input type	Platinum resistance thermometer				
Name	Pt100		JPt100		
Temperature range °C	1800	-	-	-	-
	1700	-	-	-	-
	1600	-	-	-	-
	1500	-	-	-	-
	1400	-	-	-	-
1300	-	-	-	-	-
1200	-	-	-	-	-
1100	-	-	-	-	-
1000	-	-	-	-	-
900	-	-	-	-	-
800	850	-	-	-	-
700	-	-	-	-	-
600	-	-	-	-	-
500	-	-	-	-	-
400	-	500.0	-	500.0	-
300	-	-	-	-	-
200	-	-	-	-	-
100	-	-	-	-	-
0	-	-	-	-	-
-100	-	-	100.0	-	100.0
-200	-200	-199.9	0.0	-199.9	0.0
Set value	0	1	2	3	4

Note: Lightly shaded ranges indicate default settings.

Input type	Thermocouple											ES1A Non-contact Temperature Sensor				Analog input			
Name	K	J		T	E	L	U	N	R	S	B	K10 to 70°C	K60 to 120°C	K115 to 165°C	K160 to 260°C	0 to 50 mV			
Temperature range °C	1800	-	-	-	-	-	-	-	-	-	1800	-	-	-	-	-			
	1700	-	-	-	-	-	-	-	-	-	-	-	-	-	-	-			
	1600	-	-	-	-	-	-	-	-	-	-	-	-	-	-	-			
	1500	-	-	-	-	-	-	-	-	-	-	-	-	-	-	-			
	1400	-	-	-	-	-	-	-	-	-	-	-	-	-	-	-			
	1300	1300	-	-	-	-	-	-	-	-	-	-	-	-	-	-			
	1200	-	-	-	-	-	-	-	-	-	-	-	-	-	-	-			
	1100	-	-	-	-	-	-	-	-	-	-	-	-	-	-	-			
	1000	-	-	-	-	-	-	-	-	-	-	-	-	-	-	-			
	900	-	-	-	-	-	-	-	-	-	-	-	-	-	-	-			
	800	-	-	850	-	-	-	-	-	-	-	-	-	-	-	-			
	700	-	-	-	-	-	600	-	-	-	-	-	-	-	-	-			
	600	-	-	-	-	-	-	-	850	-	-	-	-	-	-	-			
	500	-	-	-	-	-	-	-	-	-	-	-	-	-	-	-			
	400	-	500.0	-	-	-	-	-	-	-	-	-	-	-	-	-			
300	-	-	-	-	-	-	-	-	-	-	-	-	-	-	-				
200	-	-	-	-	-	-	-	-	-	-	-	-	-	-	-				
100	-	-	-	-	-	-	-	-	-	-	-	-	-	-	-				
0	-	-	-	-	-	-	-	-	-	-	-	-	-	-	-				
-100	-	-20.0	-	-	-	-	-	-	-	-	-	-	-	-	-				
-200	-200	-100	-20.0	-200	-199.9	0	-100	-200	0	0	100	0	0	0	0				
Set value	0	1	2	3	4	17	5	6	7	18	8	9	10	11	12	13	14	15	16

Applicable standards by input type are as follows:

- K, J, T, E, N, R, S, B: JIS C1602-1995
- L: Fe-CuNi, DIN 43710-1985
- U: Cu-CuNi, DIN 43710-1985
- JPt100: JIS C1604-1989, JIS C1606-1989
- Pt100: JIS C1604-1997, IEC751

Specifications

■ RATINGS

Supply voltage	100 to 240 VAC, 50/60 Hz	24 VAC, 50/60 Hz/24 VDC
Operating voltage range	85% to 110% of rated supply voltage	
Power consumption	7 VA	4 VA/2.5 W
Sensor input	Thermocouple: K, J, T, E, L, U, N, R, S, B Platinum resistance thermometer: Pt100, JPt100 Non-contact temperature sensor: 10 to 70°C, 60 to 120°C, 115 to 165°C, 160 to 260°C Voltage input: 0 to 50 mV	
Control output	Relay output	SPST-NO, 250 VAC, 2 A (resistive load), electrical life: 100,000 operations
	Voltage output	12 VDC ^{+15%} / _{-20%} (PNP), max. load current: 21 mA, with short-circuit protection circuit
Alarm output	SPST-NO, 250 VAC, 1 A (resistive load), electrical life: 100,000 operations	
Control method	PID or ON/OFF control	
Setting method	Digital setting using front panel keys	
Indication method	7-segment digital display and single-lighting indicator Character height: PV: 7.0 mm; SV: 3.5 mm	
Ambient operating temperature	-10°C to 55°C (14°F to 131°F) with no condensation or icing	
Storage temperature	-25°C to 65°C (-13°F to 149°F) with no condensation or icing	
Ambient humidity	25% to 85% RH	

■ CHARACTERISTICS

Indication accuracy	Thermocouple: $\pm 0.5\%$ of indicated value or $\pm 1^\circ\text{C}$, whichever greater, ± 1 digit max. (See Note) Platinum resistance thermometer: $\pm 0.5\%$ of indicated value or $\pm 1^\circ\text{C}$, whichever greater, ± 1 digit max. Analog input: $\pm 0.5\%$ FS ± 1 digit max. CT input: $\pm 5\%$ FS ± 1 digit max.
Hysteresis	0.1 to 999.9 EU (in units of 0.1 EU)
Proportional band (P)	0.1 to 999.9 EU (in units of 0.1 EU)
Integral time (I)	0 to 3999 s (in units of 1 s)
Derivative time (D)	0 to 3999 s (in units of 1 s)
Control period	1 to 99 s (in units of 1 s)
Manual reset value	0.0% to 100.0% (in units of 0.1%)
Alarm setting range	-1999 to 9999 (decimal point position depends on input type)
Sampling period	500 ms
Insulation resistance	20 M Ω min. at 500 VDC
Dielectric strength	2000 VAC, 50 or 60 Hz for 1 min between different charging terminals
Vibration resistance	10 to 55 Hz, 10 m/s ² for 2 hours each in X, Y and Z directions
Shock resistance	300 m/s ² , 3 times each in 3 axes, 6 directions (relay: 100 m/s ²)
Weight	Approx. 90 g; mounting bracket: Approx. 10 g
Protective structure	Front panel: NEMA4X for indoor use (equivalent to IP66), rear case: IP20, terminals: IP00
Memory protection	EEPROM non-volatile memory (number of writes: 100,000)

Note: The indication of K thermocouples in the -200 to 1300°C range, and T and N thermocouples at a temperature of -100°C or less, and U and L thermocouples at any temperature is $\pm 2^\circ\text{C} \pm 1$ digit maximum. The indication of B thermocouples at a temperature of 400°C or less is unrestricted.
The indication of R and S thermocouples at a temperature of 200°C or less is $\pm 3^\circ\text{C} \pm 1$ digit maximum.

(This table continues on the next page.)

Specifications Table – continued from previous page

EMC	Emission Enclosure:	EN55011 Group 1 class A
	Emission AC Mains:	EN55011 Group 1 class A
	Immunity ESD:	EN61000-4-2: 4 kV contact discharge (level 2) 8 kV air discharge (level 3)
	Immunity RF-interference:	ENV50140: 10 V/m (amplitude modulated, 80 MHz to 1 GHz) (level 3) 10 V/m (pulse modulated, 900 MHz)
	Immunity Conducted Disturbance:	EN50141: 10 V (0.15 to 80 MHz) (level 3)
	Immunity Burst:	EN61000-4-4: 2 kV power-line (level 3) 2 kV I/O signal-line (level 4)
Approved standards	UL3121-1, CSA22.2 No. 14, E.B.1402C Conforms to EN50081-2, EN50082-2, EN61010-1 (IEC61010-1)	

■ COMMUNICATIONS SPECIFICATIONS

Transmission path connection	Multiple points
Communications method (See Note)	RS-485 (two-wire, half duplex)
Synchronization method	Start-stop synchronization
Baud rate	1,200/2,400/4,800/9,600/19,200 bps
Transmission code	ASCII
Data bit length (See Note)	7 or 8 bits
Stop bit length (See Note)	1 or 2 bits
Error detection	Vertical parity (none, even, odd) Frame check sequence (FCS): with SYSMAC WAY Block check character (BCC): with CompoWay/F
Flow control	Not available
Interface (See Note)	RS-485
Retry function	Not available
Communications buffer	40 bytes

Note: The baud rate, data bit length, stop bit length, or vertical parity can be individually set using the communications setting level.

Nomenclature

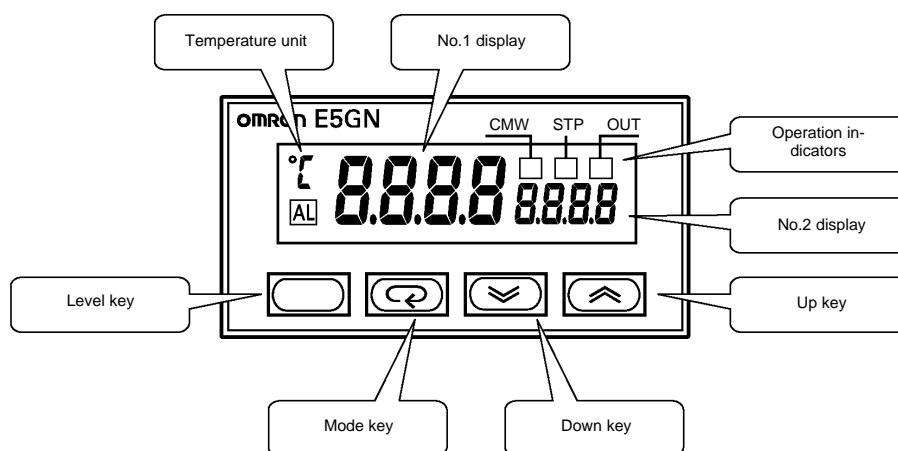

Dimensions

Unit: mm (inch)

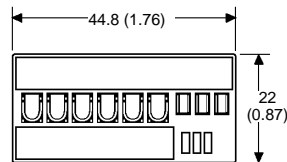
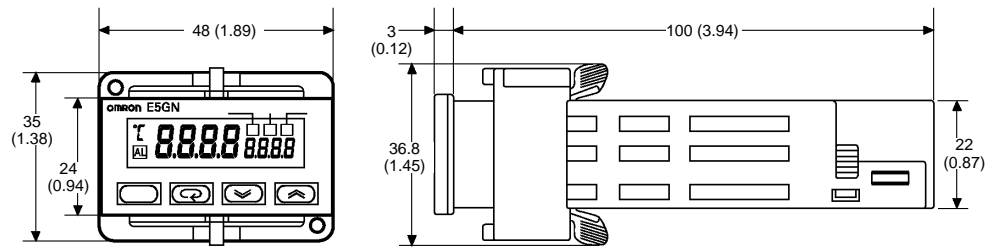
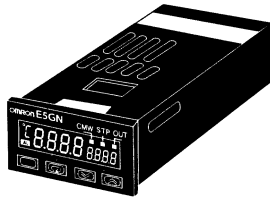

* When carrying out maintenance on the E5GN, only the terminal plate can be drawn out with the terminal leads still attached.

Panel Cutout

Mounted Separately

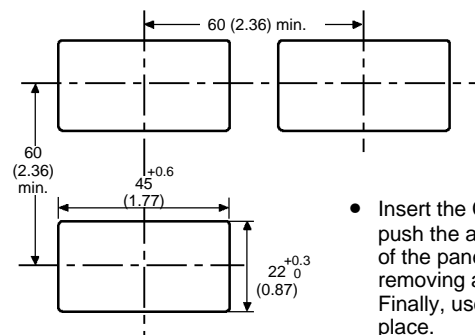

Group Mounted

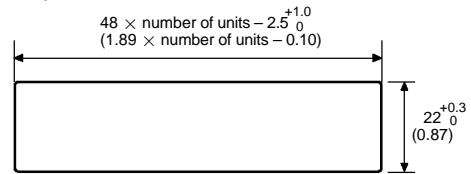

Mounting separately does not allow waterproofing.

- Insert the Controller through the hole in the panel from the front and push the adapter on from the rear. Push the adapter up to the back of the panel ensuring that the controller is pushed all the way in, removing any gap between the Controller, panel, and adapter. Finally, use the two screws on the adapter to secure the unit in place.
- To mount the E5GN so that it is waterproof, insert the waterproof packing onto the E5GN.
- When two or more E5GN Controllers are mounted, make sure that the surrounding temperature does not exceed the allowable operating temperature ranges in the specifications.

Wiring Terminals

- The voltage output (control output) is not electrically insulated from the internal circuits. When using a grounding thermocouple, do not connect the control output terminals to the ground. If the control output terminals are connected to the ground, errors will occur in the measured temperature values as a result of leakage current.
- Standard insulation is applied to the power supply I/O sections. If reinforced insulation is required, connect the input and output terminals to a device without any exposed current-carrying parts or to a device with standard insulation suitable for the maximum operating voltage of the power supply I/O section.

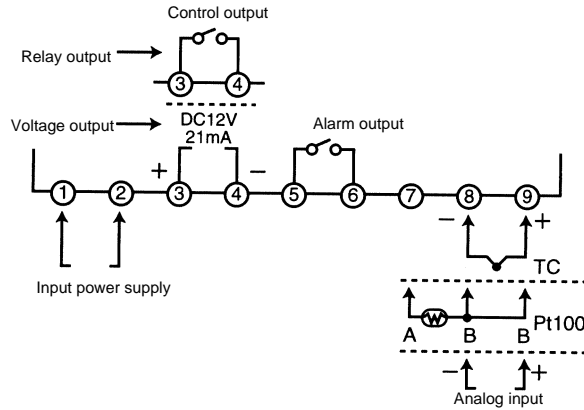

Two input power supplies are available:
100 to 240 VAC or 24 VAC/VDC (no polarity).

OMRON[®]
OMRON ELECTRONICS, INC.
 One East Commerce Drive
 Schaumburg, IL 60173
1-800-55-OMRON

OMRON CANADA, INC.
 885 Milner Avenue
 Scarborough, Ontario M1B 5V8
416-286-6465