

MITSUBISHI SEMICONDUCTOR (TRIAC)
BCR25A, BCR25B

MEDIUM POWER USE
 NON-INSULATED TYPE, GLASS PASSIVATION TYPE

BCR25A, BCR25B



- I_T (RMS) 25A
- V_{DRM} 400V/500V
- IFGT I , IRGT II 50mA
- IRGT I 75mA

APPLICATION

Contactless AC switches, light dimmer,
 on/off control of copier lamps

OUTLINE DRAWING

Dimensions
 in mm

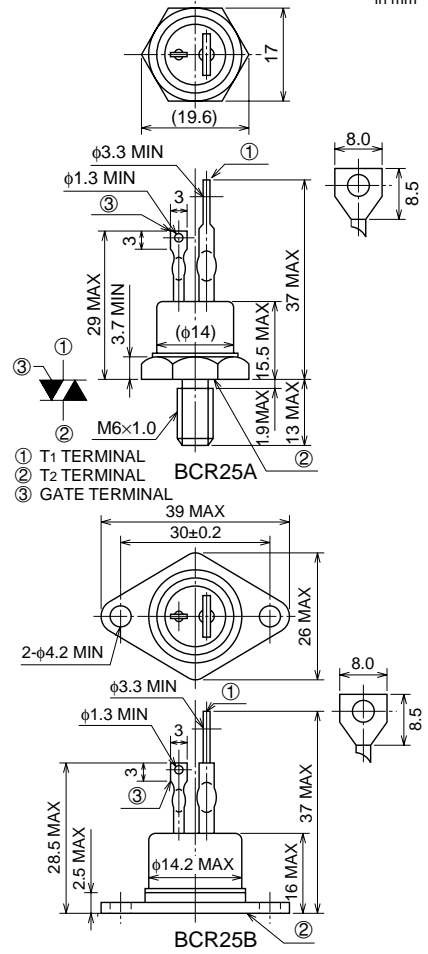

MAXIMUM RATINGS

Symbol	Parameter	Voltage class		Unit
		8	10	
V_{DRM}	Repetitive peak off-state voltage*1	400	500	V
V_{DSM}	Non-repetitive peak off-state voltage*1	600	600	V

Symbol	Parameter	Conditions	Ratings	Unit
I_T (RMS)	RMS on-state current	Commercial frequency, sine full wave, 360° conduction, $T_c=92^\circ\text{C}$	25	A
I_{TSM}	Surge on-state current	60Hz sinewave 1 full cycle, peak value, non-repetitive	250	A
I^2t	I^2t for fusing	Value corresponding to 1 cycle of half wave 60Hz, surge on-state current	262	A ² s
PGM	Peak gate power dissipation		5.0	W
PG (AV)	Average gate power dissipation		0.5	W
VGM	Peak gate voltage		10	V
IGM	Peak gate current		2.0	A
T_j	Junction temperature		-20 ~ +125	°C
T_{stg}	Storage temperature		-20 ~ +125	°C
—	Mounting torque	BCR25A only	30	kg-cm
			2.94	N-m
—	Weight	BCR25A (Typical value)	18	g
		BCR25B (Typical value)	23	

*1. Gate open.

BCR25A, BCR25B

MEDIUM POWER USE
NON-INSULATED TYPE, GLASS PASSIVATION TYPE

ELECTRICAL CHARACTERISTICS

Symbol	Parameter	Test conditions	Limits			Unit	
			Min.	Typ.	Max.		
IDRM	Repetitive peak off-state current	T _j =125°C, V _{DRM} applied	—	—	5.0	mA	
VTM	On-state voltage	T _c =25°C, I _{TM} =40A, Instantaneous measurement	—	—	1.6	V	
VFGT I	Gate trigger voltage *2	T _j =25°C, V _D =6V, R _L =6Ω, R _G =330Ω	I	—	—	3.0	V
VRGT I			II	—	—	3.0	V
VRGT III			III	—	—	3.0	V
IFGT I	Gate trigger current *2	T _j =25°C, V _D =6V, R _L =6Ω, R _G =330Ω	I	—	—	50	mA
IRGT I			II	—	—	75	mA
IRGT III			III	—	—	50	mA
VGD	Gate non-trigger voltage	T _j =125°C, V _D =1/2V _{DRM}	0.2	—	—	V	
R _{th(j-c)}	Thermal resistance	Junction to case	—	—	1.0	°C/W	
(dv/dt) _c	Critical-rate of rise of off-state commutating voltage		*3	—	—	V/μs	

*2. Measurement using the gate trigger characteristics measurement circuit.

*3. The critical-rate of rise of the off-state commutating voltage is shown in the table below.

Voltage class	V _{DRM} (V)	(dv/dt) _c			Test conditions	Commutating voltage and current waveforms (inductive load)
		Symbol	Min.	Unit		
8	400	R	—	V/μs	1. Junction temperature T _j =125°C 2. Rate of decay of on-state commutating current (di/dt) _c =-13.5A/ms 3. Peak off-state voltage V _D =400V	
		L	20			
10	500	R	—			
		L	20			

PERFORMANCE CURVES

MAXIMUM ON-STATE CHARACTERISTICS

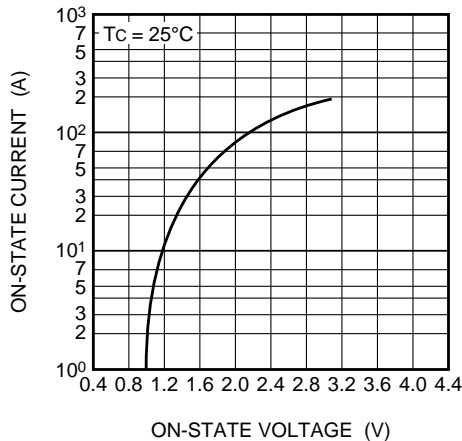

RATED SURGE ON-STATE CURRENT

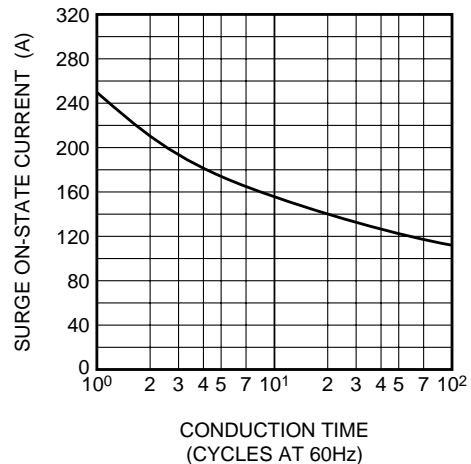

BCR25A, BCR25B

MEDIUM POWER USE

NON-INSULATED TYPE, GLASS PASSIVATION TYPE

GATE CHARACTERISTICS

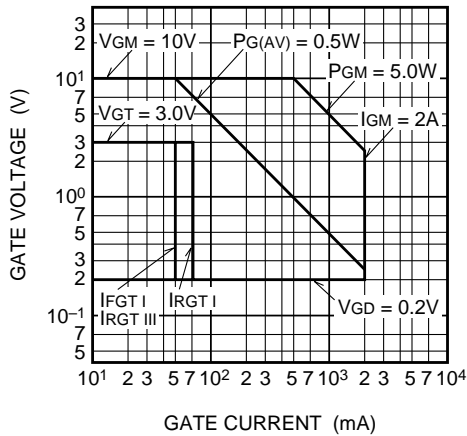

GATE TRIGGER CURRENT-VOLTAGE VS. JUNCTION TEMPERATURE

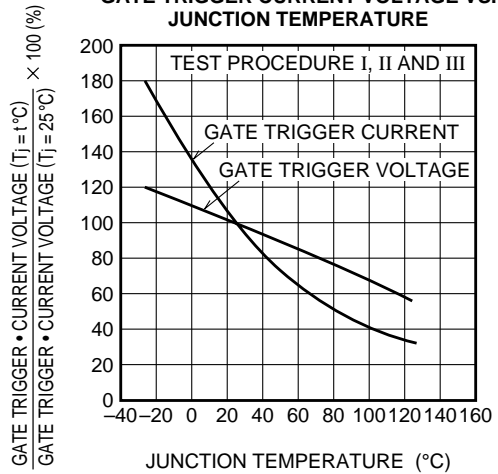

MAXIMUM TRANSIENT THERMAL IMPEDANCE CHARACTERISTICS (JUNCTION TO CASE)

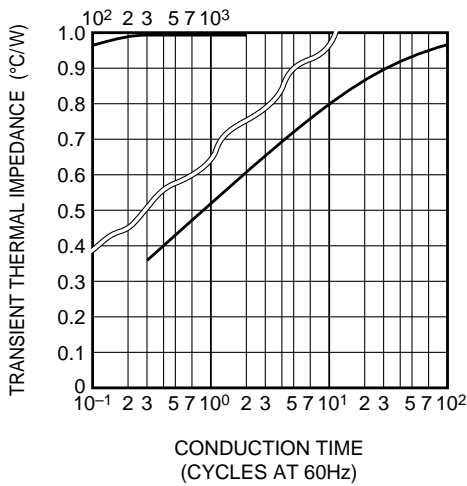

MAXIMUM ON-STATE POWER DISSIPATION

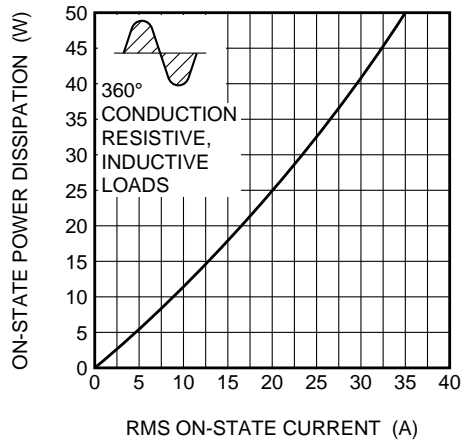

ALLOWABLE CASE TEMPERATURE VS. RMS ON-STATE CURRENT

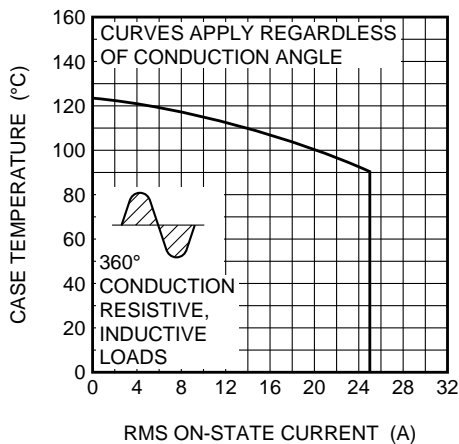

ALLOWABLE AMBIENT TEMPERATURE VS. RMS ON-STATE CURRENT (BCR25A)

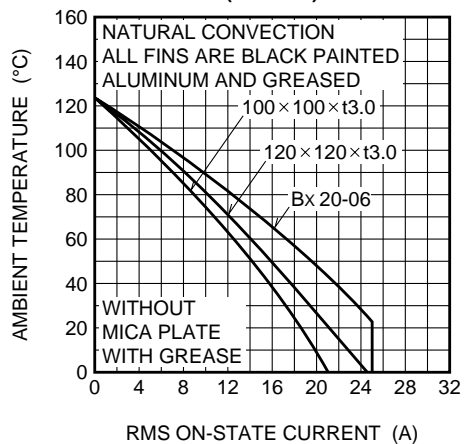

BCR25A, BCR25B

MEDIUM POWER USE
NON-INSULATED TYPE, GLASS PASSIVATION TYPE

**ALLOWABLE AMBIENT TEMPERATURE
VS. RMS ON-STATE CURRENT
(BCR25B)**

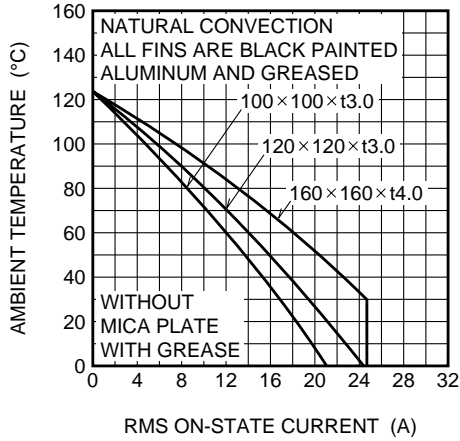

**BREAKOVER VOLTAGE VS.
JUNCTION TEMPERATURE**

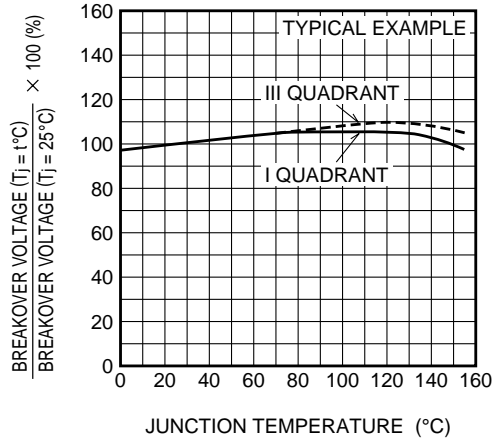

COMMUTATION CHARACTERISTICS

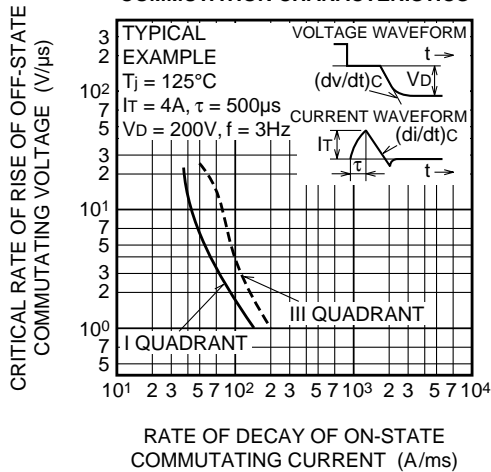

**GATE TRIGGER CURRENT VS.
GATE CURRENT PULSE WIDTH**

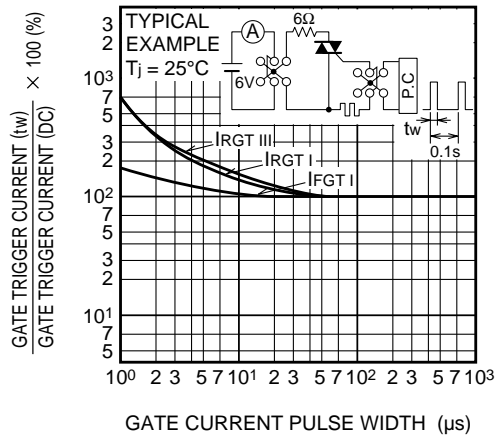

GATE TRIGGER CHARACTERISTICS TEST CIRCUITS

