

Block Diagram

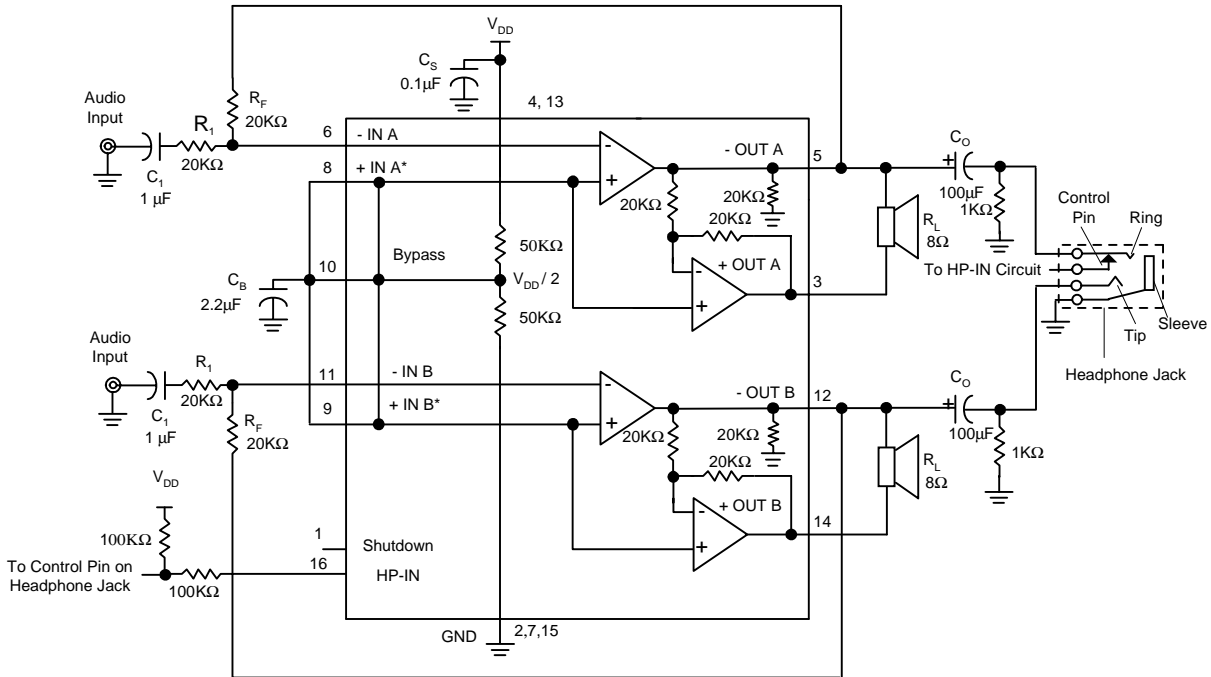

* +INA and +INB pins are connected to Bypass pin inside the IC.

Absolute Maximum Ratings

(Over operating free-air temperature range unless otherwise noted.)

Symbol	Parameter	Rating	Unit
V_{DD}	Supply Voltage	6	V
T_A	Operating Ambient Temperature Range	-40 to 85	°C
T_J	Maximum Junction Temperature	150	°C
T_{STG}	Storage Temperature Range	-65 to +150	°C
T_S	Soldering Temperature, 10 seconds	260	°C
V_{ESD}	Electrostatic Discharge	-2000 to 2000 ^{*1}	V

Note: *1. Human body model : C=100pF, R=1500Ω, 3 positive pulses plus 3 negative pulses

Recommended Operating Conditions

		Min.	Typ.	Max.	Unit
Supply Voltage, V_{DD}		3	5	5.5	V
Operating free-air temperature, T_A	$V_{DD}=5V$, 250mW/Ch average power 4- Ω stereo BTL drive, with proper PCB design	-20		85	$^{\circ}C$
	$V_{DD}=5V$, 1.8 W/Ch average power 4- Ω stereo BTL drive, with proper PCB design and 300 CFM forced-air cooling	-20		85	
Common mode input voltage, V_{ICM}	$V_{DD}=5 V$	1.25		4.5	V
	$V_{DD}=3.3V$	1.25		2.7	

Dissipation Rating Table

Package	Air Flow (CFM)	Thermal Resistance $\theta_{JA}(^{\circ}C/W)$	$T_A \leq 25^{\circ}C$	$T_A = 70^{\circ}C$
SO16 +	0	50	2.5W	1.6W
TSSOP ++	0	73.2	1.7W	1.1W
	200	66.6	1.8W	1.2W
TSSOP-P ++	0	37.6	3.3W	2.1W
	200	32.3	3.8W	2.4W

+ : The parameter is measured with the recommended copper heat sink pattern on an 2-layer PCB, 11.7 in² 3.0x2.4 in² in PCB, 1oz. copper, 3.0x1.5 in² in coverage at Top-layer and Bottom-layer at 100% coverage (7.2in²).
 ++:The parameter is measured with the JEDEC standard test boards (multi-layer PCB).

Electical Characteristics

Electrical Characteristics for Entire IC

The following specifications apply for $V_{DD}=5V$ unless otherwise noted. Limits apply for $T_A=25^{\circ}C$

Symbol	Parameter	Test Conditions	APA4863			Unit
			Min.	Typ.	Max.	
V_{DD}	Supply Voltage		3		5.5	V
I_{DD}	Quiescent Power Supply Current	$V_{IN}=0V, I_O=0A, HP-IN=0V$		9	13.5	mA
		$V_{IN}=0V, I_O=0A, HP-IN=4V$		5	7.5	
I_{SD}	Shutdown Current	$V_{PIN1}=V_{DD}$	5	0.5		μA
V_{IH}	Headphone High Input Voltage		4			V
V_{IL}	Headphone Low Input Voltage				0.8	V

Electical Characteristics Cont.

Electrical Characteristics for BTL Mode Operation

The following specifications apply for $V_{DD}=5V$ unless otherwise noted. Limits apply for $T_A=25^\circ C$

Symbol	Parameter	Test Conditions	APA4863	Unit
			Typ.	
V_{OS}	Output Offset Voltage	$V_{IN}=0V$	5	mV
P_O	Output Power	THD=1%, f=1kHz $R_L=3\Omega$ $R_L=4\Omega$ $R_L=8\Omega$	2.2 1.8 1.2	W
		THD=10%, f=1kHz $R_L=3\Omega$ $R_L=4\Omega$ $R_L=8\Omega$	2.7 2.3 1.5	
THD+N	Total Harmonic Distortion + Noise	$A_{VD}=2$, f=1kHz $R_L=4\Omega$, $P_O=1.8W$ $R_L=8\Omega$, $P_O=1W$	0.3 0.15	%
RSRR	Power Supply Rejection Ratio	$V_{DD}=5V$, $V_{RIPPLE}=200mV_{RMS}$, $R_L=8\Omega$ $C_B=2.2\mu F$	64	dB
X_{TALK}	Channel Separation	f=1kHz, $C_B=2.2\mu F$, $P_O=1W$, $R_L=8\Omega$	90	dB
SNR	Signal-to-Noise Ratio	$V_{DD}=5V$, $P_O=1.1W$, $R_L=8\Omega$	95	dB

Electrical Characteristics for SE Mode Operation

The following specifications apply for $V_{DD}=5V$ unless otherwise noted. Limits apply for $T_A=25^\circ C$

Symbol	Parameter	Test Conditions	APA4863	Unit
			Typ.	
V_{OS}	Output Offset Voltage	$V_{IN}=0V$	5	mV
P_O	Output Power	THD=0.5%, f=1kHz, $R_L=32\Omega$	90	mW
		THD=1%, f=1kHz, $R_L=8\Omega$	320	
		THD=10%, f=1kHz, $R_L=8\Omega$	400	
THD+N	Total Harmonic Distortion plus Noise	$A_V=-1$, $P_O=75mW$, f=1kHz, $R_L=32\Omega$	0.02	%
RSRR	Power Supply Rejection Ratio	$V_{RIPPLE}=200mV_{RMS}$, f=1kHz, $C_B=2.2\mu F$, $R_L=8\Omega$	49	dB
X_{TALK}	Channel Separation	f=1kHz, $C_B=2.2\mu F$, $P_O=32mW$, $R_L=32\Omega$	85	dB
SNR	Signal-to-Noise Ratio	$V_{DD}=5V$, $P_O=340mW$, $R_L=8\Omega$	95	dB

Truth Table for Logic Inputs

Shutdown	HP-IN	APA4863 Mode
Low	Low	Bridge -Tied
Low	High	Single-Ended
High	Low	APA4863 Shutdown
High	High	APA4863 Shutdown

Pin Description

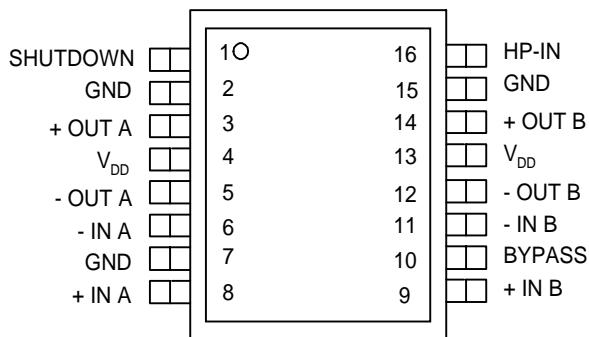

Top View
for SOP

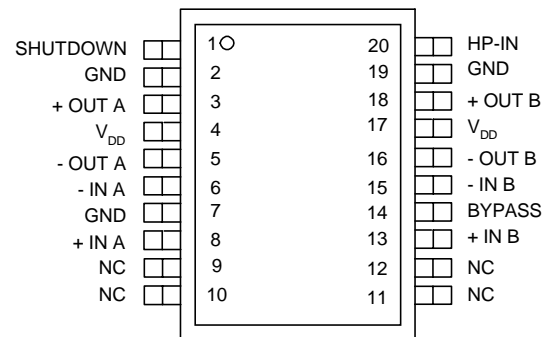

Top View
for TSSOP

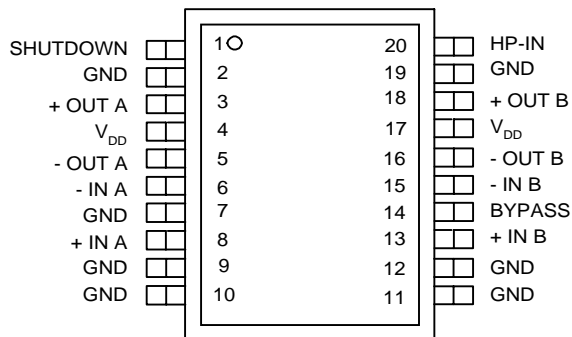

Top View
for TSSOP-P

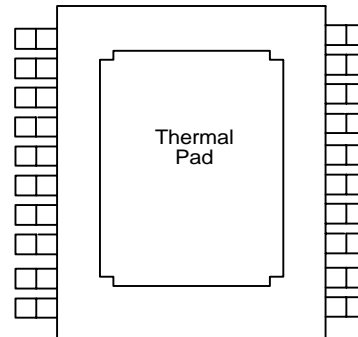

Bottom View
for TSSOP -P

Pin Description

Name	I/O	Description
GND		Ground connection of circuitry
V _{DD}	I	Supply voltage input
+ INA	I	Non-inverting input of channel A, connected to bypass pin inside the IC
- INA	I	Input pin of channel A
+ OUT A	O	A channel + output in BTL mode, high impedance in SE mode
- OUT A	O	A channel - output in BTL mode, + output in SE mode
+ IN B	I	Non-inverting input of channel B, connected to bypass pin inside the IC
- IN B	I	Input pin of channel B
+ OUT B	O	B channel + output in BTL mode, high impedance in SE mode
- OUT B	O	B channel - output in BTL mode, + output in SE mode
BYPASS		Connect to voltage divider for internal mid-supply bias
HP-IN	I	Headphone control pin input, hold high for single-ended mode operation
SHUTDOWN	I	Shutdown mode control pin input, places entire IC in shutdown mode when held high, I _{DD} = 0.5μA

Typical Characteristics

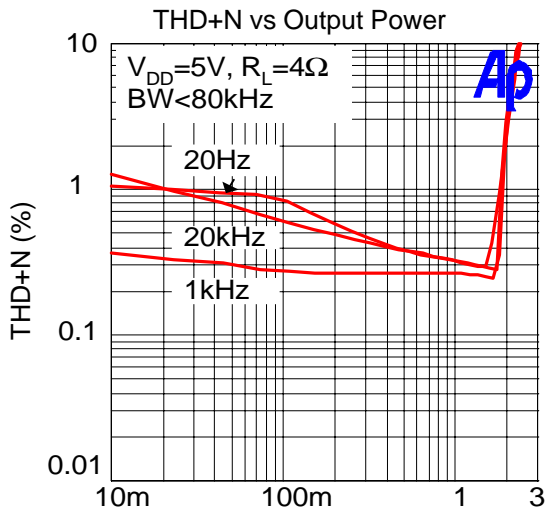

Figure 1 : Output Power (W)

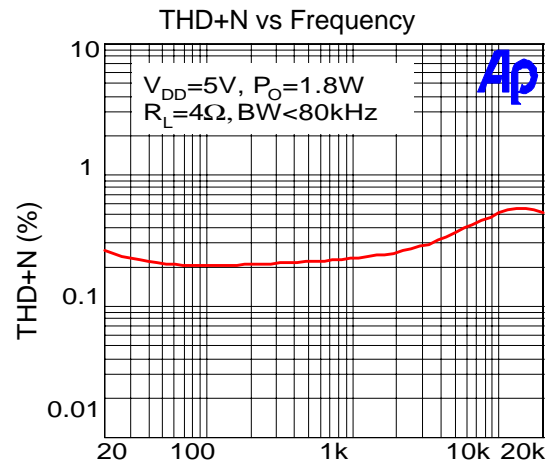

Figure 2 : Frequency (Hz)

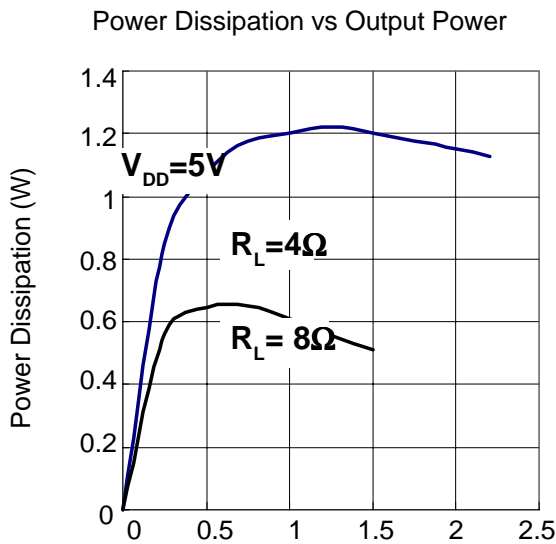

Figure 3 : Output Power (W)

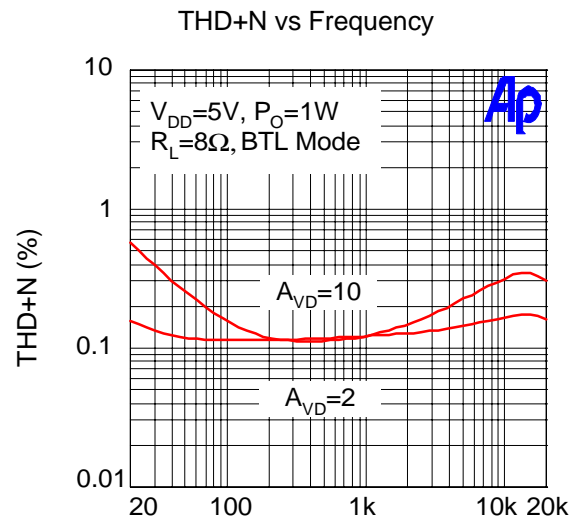

Figure 4 : Frequency (Hz)

Typical Characteristics Cont.

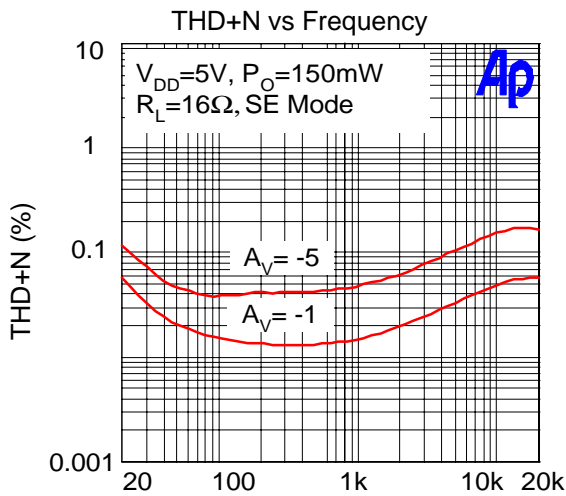

Figure 5 : Frequency (Hz)

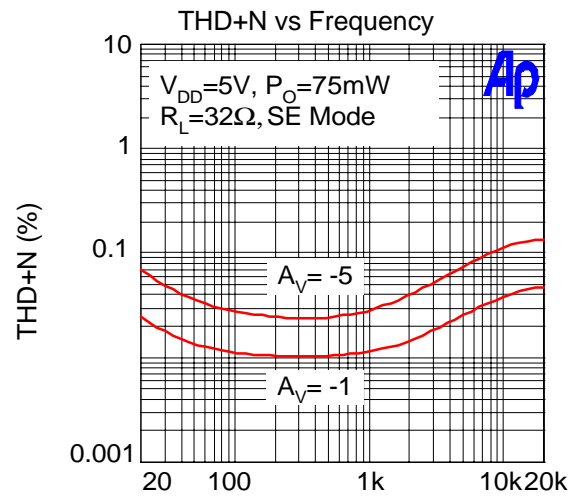

Figure 6 : Frequency (Hz)

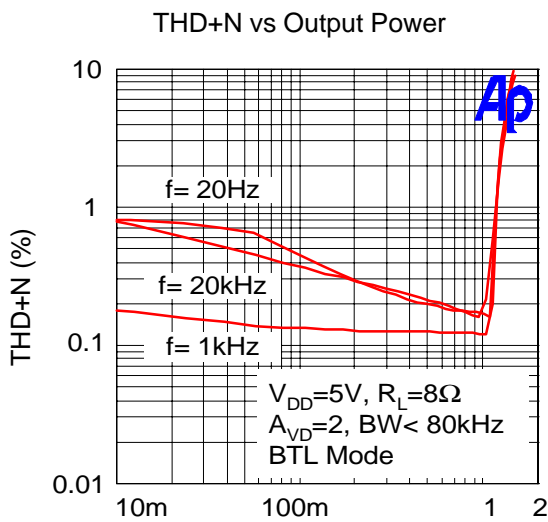

Figure 7 : Output Power (W)

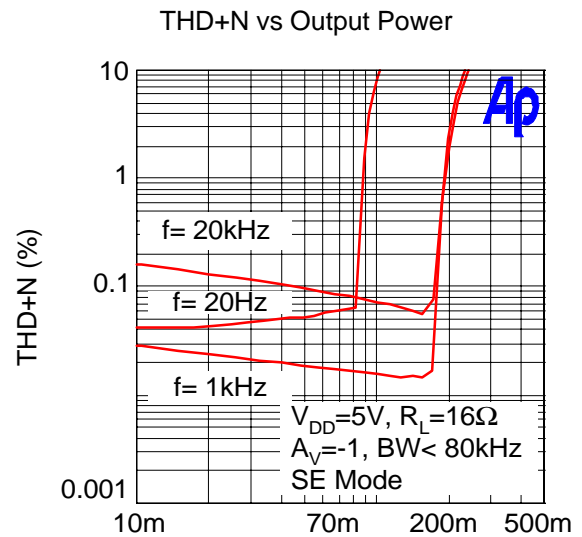

Figure 8 : Output Power (W)

Typical Characteristics Cont.

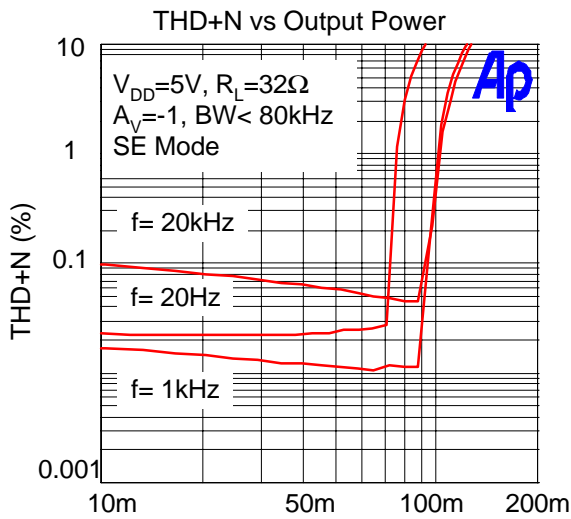

Figure 9 : Output Power (W)

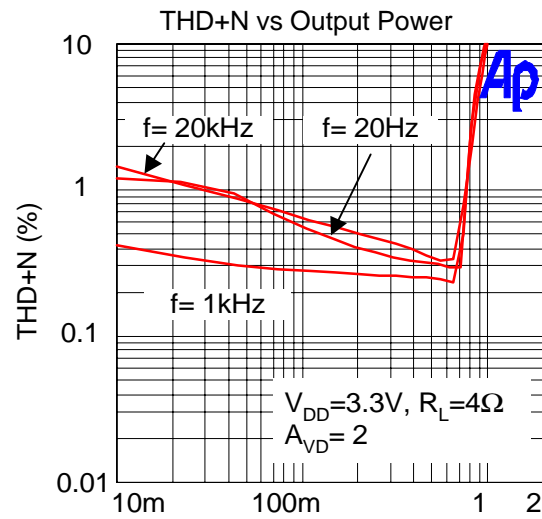

Figure 10 : Output Power (W)

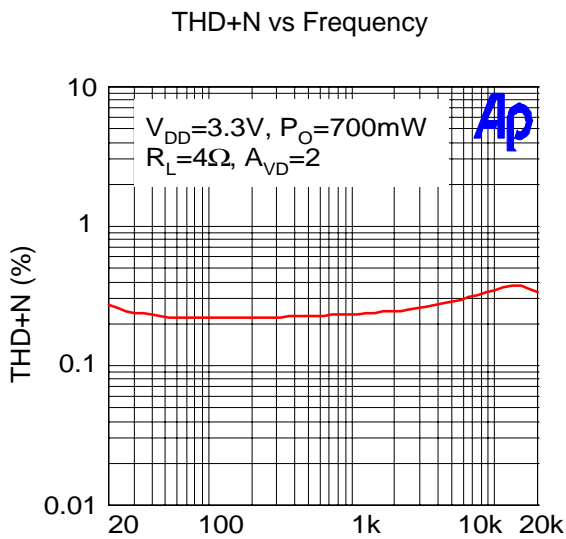

Figure 11 : Frequency (Hz)

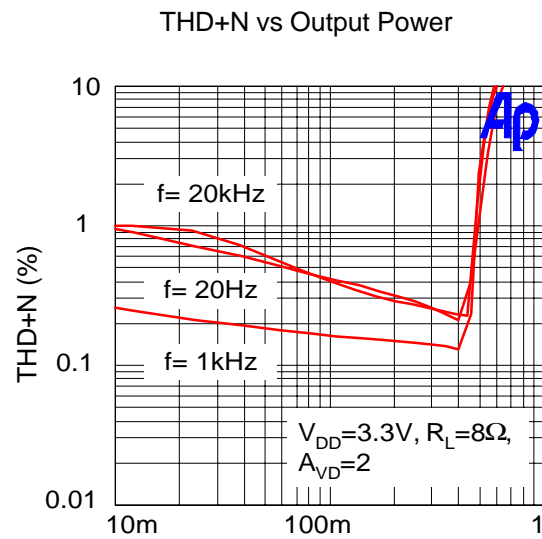

Figure 12 : Output Power (W)

Typical Characteristics Cont.

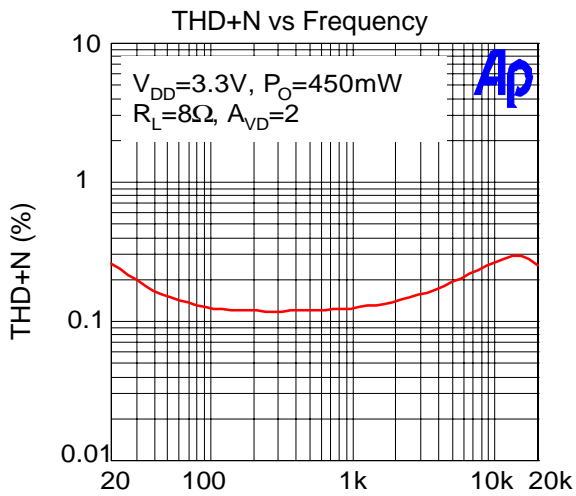

Figure 13 : Frequency (Hz)

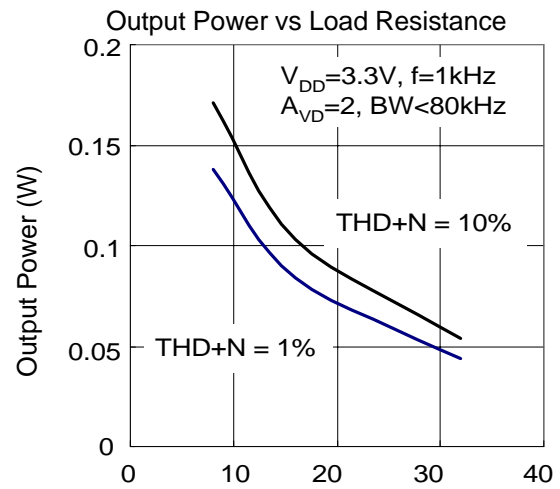

Figure 14 : Load Resistance (Ω)

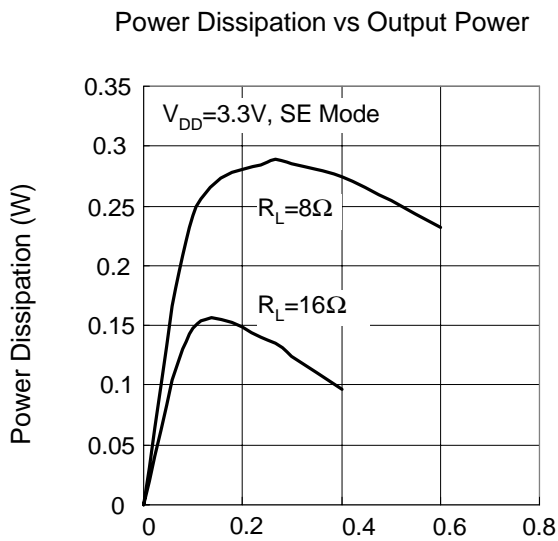

Figure 15 : Output Power (W)

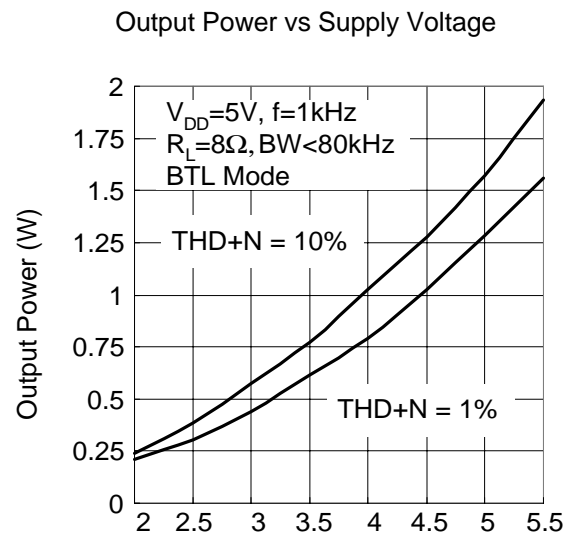

Figure 16 : Supply Voltage (V)

Typical Characteristics Cont.

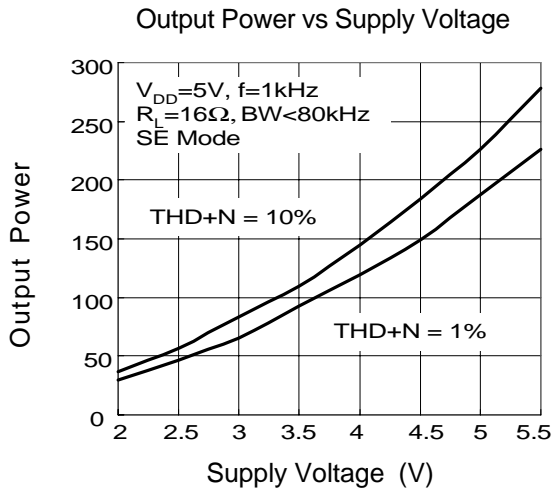

Figure 17

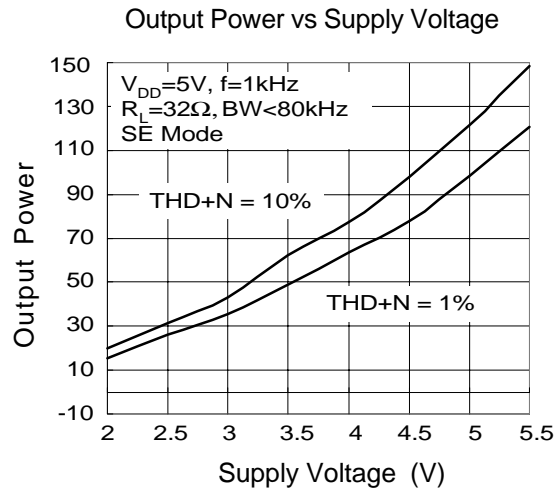

Figure 18

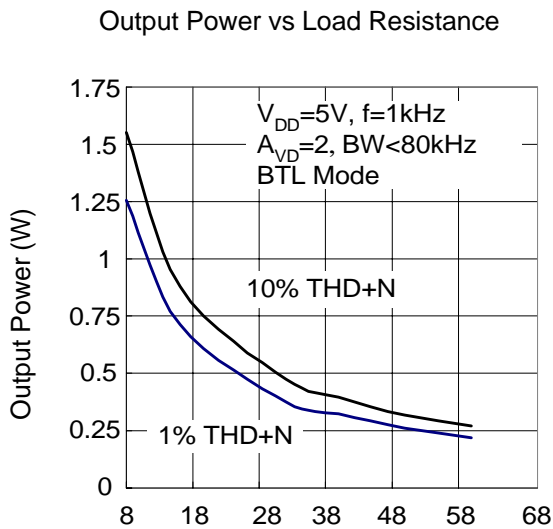

Figure 19 : Load Resistance (Ω)

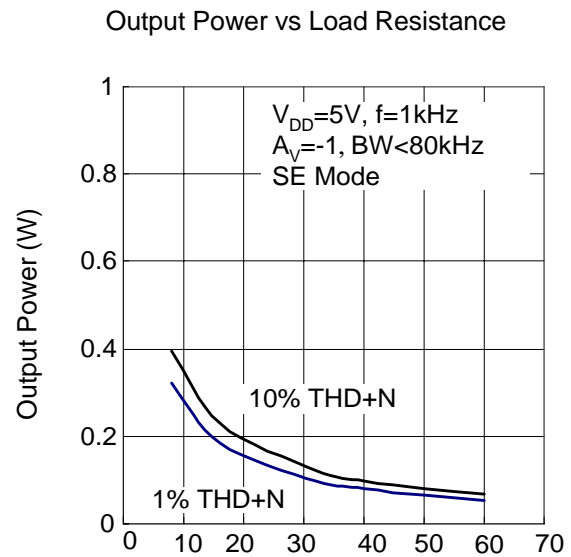

Figure 20 : Load Resistance (Ω)

Typical Characteristics Cont.

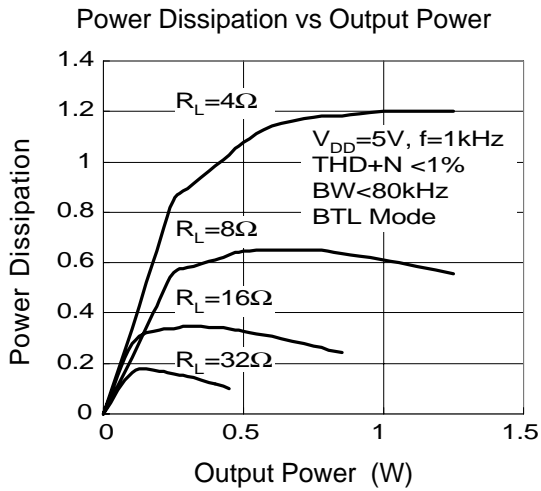

Figure 21

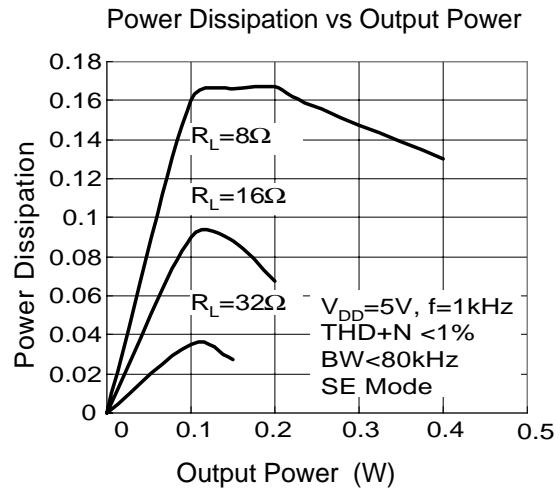

Figure 22

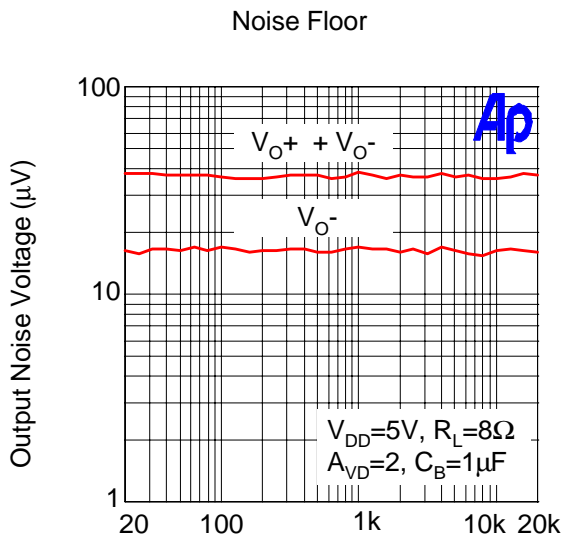

Figure 23 : Frequency (Hz)

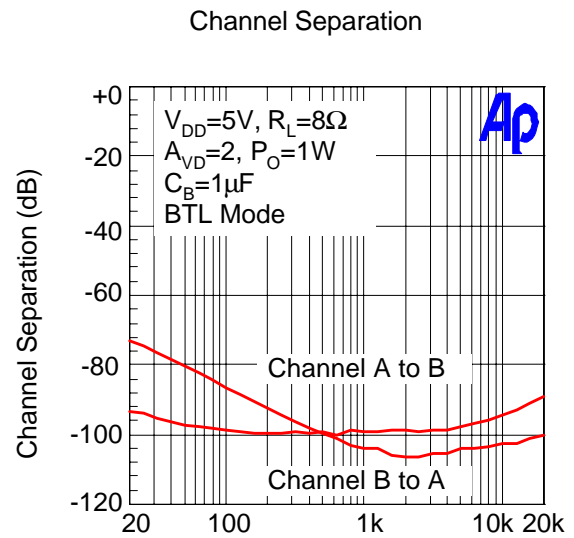

Figure 24 : Frequency (Hz)

Typical Characteristics Cont.

Channel Separation

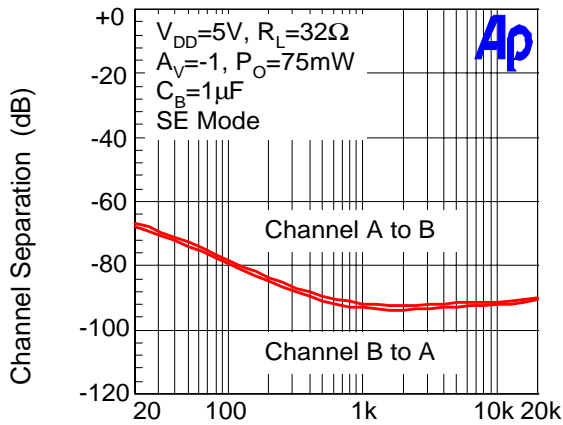

Figure 25 : Frequency (Hz)

Open Loop Frequency Response

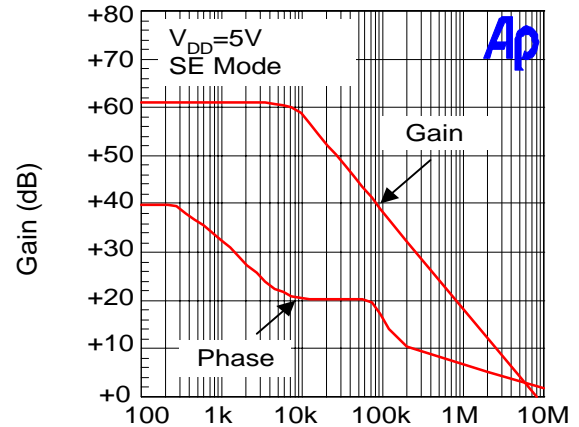

Figure 26 : Frequency (Hz)

Supply Current vs Supply Voltage

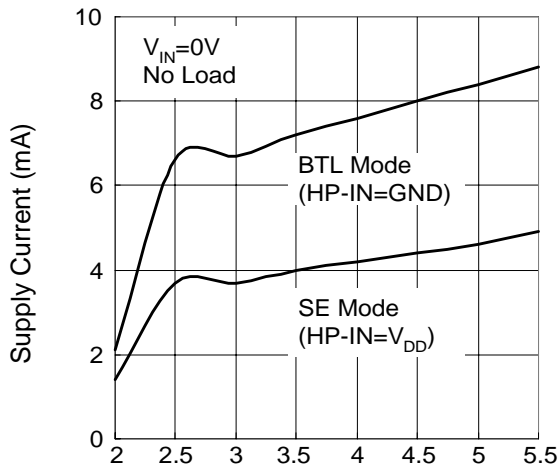
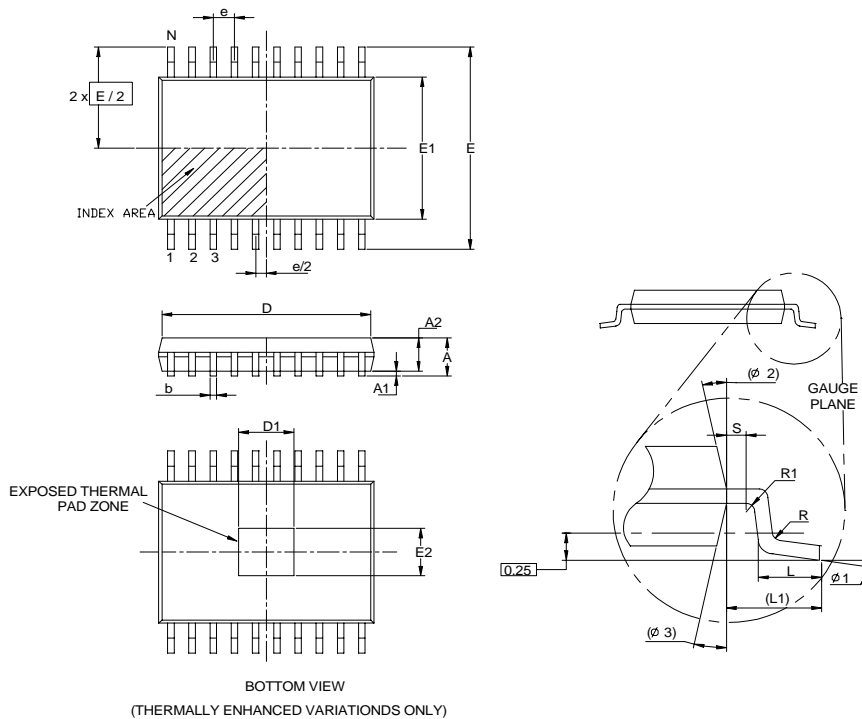

Figure 27 : Supply Voltage(V)

Packaging Information

TSSOP/ TSSOP-P (Reference JEDEC Registration MO-153)



Dim	Millimeters		Inches	
	Min.	Max.	Min.	Max.
A		1.2		0.047
A1	0.00	0.15	0.000	0.006
A2	0.80	1.05	0.031	0.041
D	6.4 (N=20PIN) 7.7 (N=24PIN)	6.6 (N=20PIN) 7.9 (N=24PIN)	0.252 (N=20PIN) 0.303 (N=24PIN)	0.260 (N=20PIN) 0.311 (N=24PIN)
D1	2.20 (N=20PIN) 2.70 (N=24PIN) Thermally Enhanced		0.087 (N=20PIN) 0.106 (N=24PIN) Thermally Enhanced	
e	0.65 BSC		0.026 BSC	
E	6.40 BSC		0.252 BSC	
E1	4.30	4.50	0.169	0.177
E2	1.50		0.059	
L	0.45	0.75	0.018	0.030
L1	1.0 REF		0.039REF	
R	0.09		0.004	
R1	0.09		0.004	
S	0.2		0.008	
$\phi 1$	0°	8°	0°	8°
$\phi 2$	12° REF		12° REF	
$\phi 3$	12° REF		12° REF	

Packaging Information

SO – 300mil (Reference JEDEC Registration MS-013)

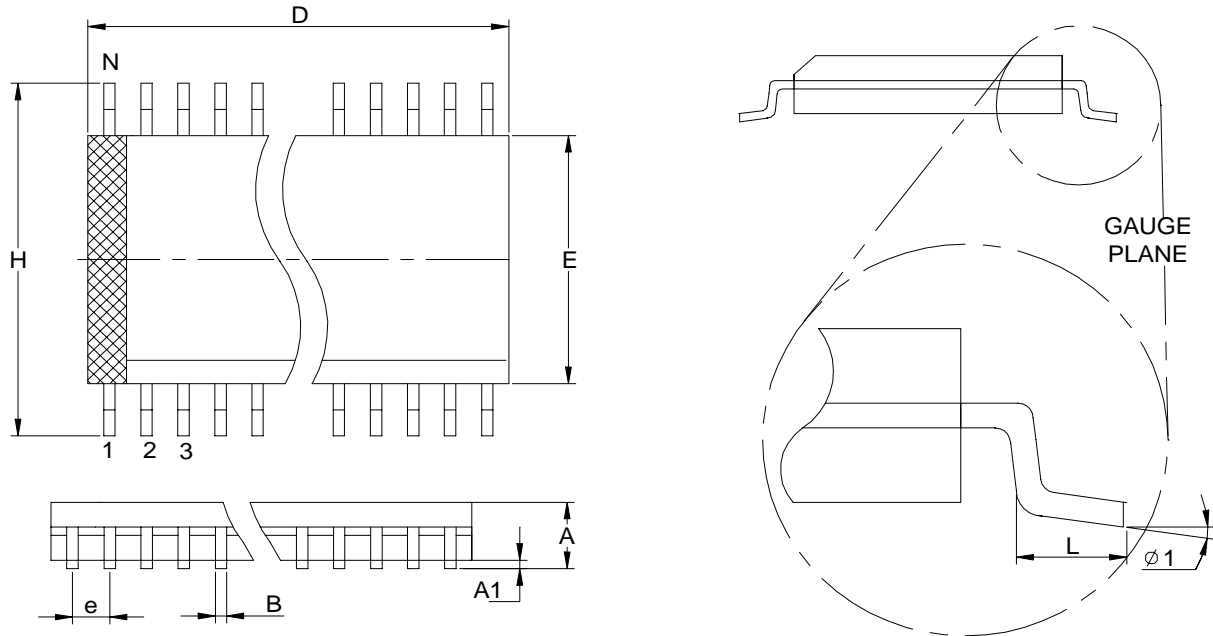

Dim	Millimeters		Variations- D			Dim	Inches		Variations- D		
	Min.	Max.	Variations	Min.	Max.		Min.	Max.	Variations	Min.	Max.
A	2.35	2.65	SO-16	10.10	10.50	A	0.093	0.1043	SO-16	0.398	0.413
A1	0.10	0.30	SO-18	11.35	11.76	A1	0.004	0.0120	SO-18	0.447	0.463
B	0.33	0.51	SO-20	12.60	13	B	0.013	0.020	SO-20	0.496	0.512
D	See variations		SO-24	15.20	15.60	D	See variations		SO-24	0.599	0.614
E	7.40	7.60	SO-28	17.70	18.11	E	0.2914	0.2992	SO-28	0.697	0.713
e	1.27BSC		SO-14	8.80	9.20	e	0.050BSC		SO-14	0.347	0.362
H	10	10.65				H	0.394	0.419			
L	0.40	1.27				L	0.016	0.050			
N	See variations					N	See variations				
φ 1	0°	8°				φ 1	0°	8°			

Physical Specifications

Terminal Material	Solder-Plated Copper (Solder Material : 90/10 or 63/37 SnPb)
Lead Solderability	Meets EIA Specification RSI86-91, ANSI/J-STD-002 Category 3.
Packaging	2000 devices per reel

Reflow Condition (IR/Convection or VPR Reflow)

Reference JEDEC Standard J-STD-020A APRIL 1999

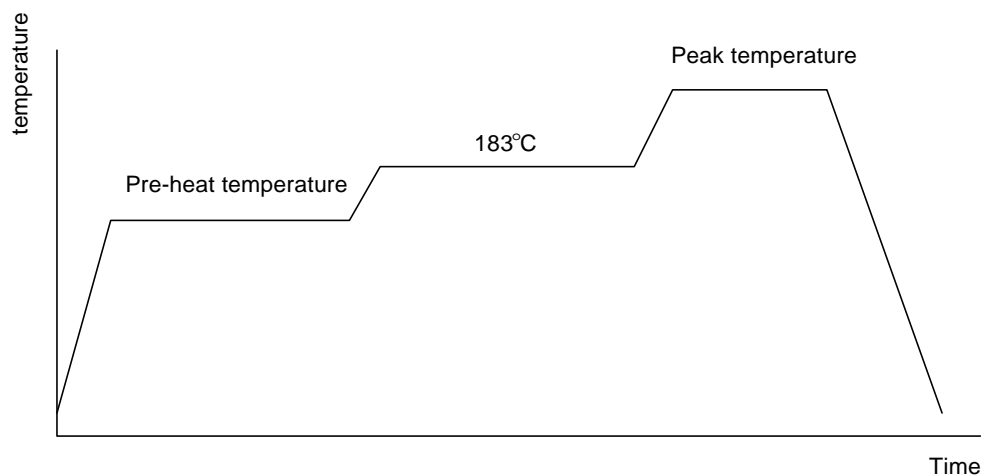

Classification Reflow Profiles

	Convection or IR/ Convection	VPR
Average ramp-up rate(183°C to Peak)	3°C/second max.	10 °C /second max.
Preheat temperature 125 ± 25°C)	120 seconds max	
Temperature maintained above 183°C	60 – 150 seconds	
Time within 5°C of actual peak temperature	10 –20 seconds	60 seconds
Peak temperature range	220 +5/-0°C or 235 +5/-0°C	215-219°C or 235 +5/-0°C
Ramp-down rate	6 °C /second max.	10 °C /second max.
Time 25°C to peak temperature	6 minutes max.	

Package Reflow Conditions

pkg. thickness ≥ 2.5mm and all bgas	pkg. thickness < 2.5mm and pkg. volume ≥ 350 mm ³	pkg. thickness < 2.5mm and pkg. volume < 350mm ³
Convection 220 +5/-0 °C		Convection 235 +5/-0 °C
VPR 215-219 °C		VPR 235 +5/-0 °C
IR/Convection 220 +5/-0 °C		IR/Convection 235 +5/-0 °C

Reliability test program

Test item	Method	Description
SOLDERABILITY	MIL-STD-883D-2003	245°C , 5 SEC
HOLT	MIL-STD-883D-1005.7	1000 Hrs Bias @ 125 °C
PCT	JESD-22-B, A102	168 Hrs, 100 % RH , 121°C
TST	MIL-STD-883D-1011.9	-65°C ~ 150°C, 200 Cycles
ESD	MIL-STD-883D-3015.7	VHBM > 2KV, VMM > 200V
Latch-Up	JESD 78	10ms , I _{tr} > 100mA

Carrier Tape & Reel Dimensions

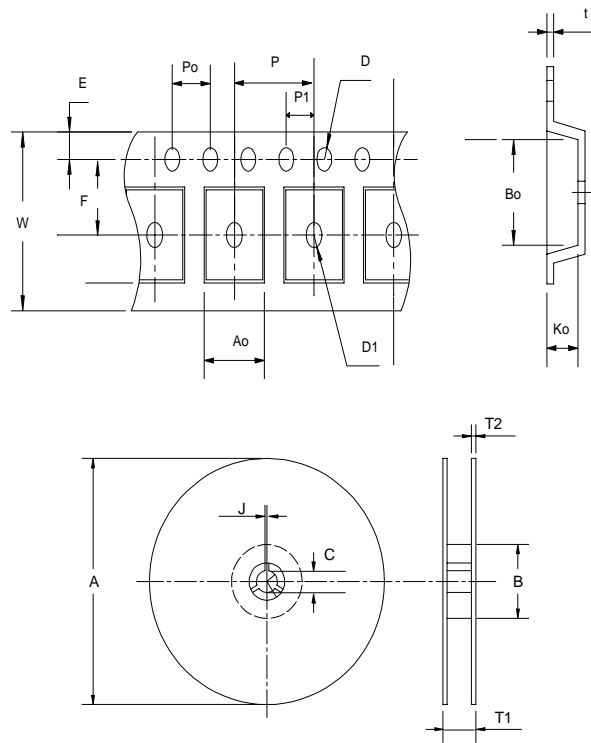

Application	A	B	C	J	T1	T2	W	P	E
SOP-16W	330±3	100 ± 2	13 + 0.5	2 ± 0.5	16.4 +0.3 -0.2	2.5± 0.5	16 ± 0.2	12± 0.1	1.75± 0.1
Application	F	D	D1	Po	P1	Ao	Bo	Ko	t
SOP-16W	7.5 ± 0.1	1.5 +0.1	1.5 +0.25	4.0 ± 0.1	2.0 ± 0.1	10.9 ± 0.1	10.8± 0.1	3.0± 0.1	0.3±0.013

(mm)

Cover Tape Dimensions

Carrier Width	16
Cover Tape Width	13.3

(mm)

Customer Service

Analog and Power Electronics Corp.

Head Office :

5F, No. 2 Li-Hsin Road, SBIP,

Hsin-Chu, Taiwan, R.O.C.

Tel : 886-3-5642000

Fax : 886-3-5642050

Taipei Branch :

24F-1. No. 268, Sec. 2, PeiHsin Rd.

HsinDian, Taipei County, Taiwan, R. O. C.

Tel : 886-2-86658533

Fax : 886-2-86658529