

### FEATURES

- 125 MSPS guaranteed sampling rate (AD9445BSV-125)
- 78.3 dBFS SNR/92 dBFS SFDR with 30 MHz input (3.2 V p-p)
- 74.8 dBFS SNR/95 dBFS SFDR with 30 MHz input (2.0 V p-p)
- 77.0 dBFS SNR/87 dBFS SFDR with 170 MHz input (3.2 V p-p)
- 74.6 dBFS SNR/95 dBFS SFDR with 170 MHz input (2.0 V p-p)
- 73.0 dBFS SNR/88 dBFS SFDR with 300 MHz input (2.0 V p-p)
- 102 dBFS 2-tone SFDR with 30 MHz and 31 MHz
- 92 dBFS 2-tone SFDR with 170 MHz and 171 MHz
- 60 fsec rms jitter
- Excellent linearity
  - DNL =  $\pm 0.25$  LSB typical
  - INL =  $\pm 0.8$  LSB typical
- 2.0 V p-p to 4.0 V p-p differential full-scale input
- Buffered analog inputs
- LVDS outputs (ANSI-644 compatible) or CMOS outputs
- Data format select (offset binary or twos complement)
- Output clock available
- 3.3 V and 5 V supply operation

### APPLICATIONS

- Multicarrier, multimode cellular receivers
- Antenna array positioning
- Power amplifier linearization
- Broadband wireless
- Radar
- Infrared imaging
- Medical imaging
- Communications instrumentation

### GENERAL DESCRIPTION

The AD9445 is a 14-bit, monolithic, sampling analog-to-digital converter (ADC) with an on-chip IF sampling track-and-hold circuit. It is optimized for performance, small size, and ease of use. The product operates at up to a 125 MSPS conversion rate and is designed for multicarrier, multimode receivers, such as those found in cellular infrastructure equipment.

The ADC requires 3.3 V and 5.0 V power supplies and a low voltage differential input clock for full performance operation. No external reference or driver components are required for many applications. Data outputs are CMOS or LVDS compatible (ANSI-644 compatible) and include the means to reduce the overall current needed for short trace distances.

#### Rev. 0

Information furnished by Analog Devices is believed to be accurate and reliable. However, no responsibility is assumed by Analog Devices for its use, nor for any infringements of patents or other rights of third parties that may result from its use. Specifications subject to change without notice. No license is granted by implication or otherwise under any patent or patent rights of Analog Devices. Trademarks and registered trademarks are the property of their respective owners.

### FUNCTIONAL BLOCK DIAGRAM

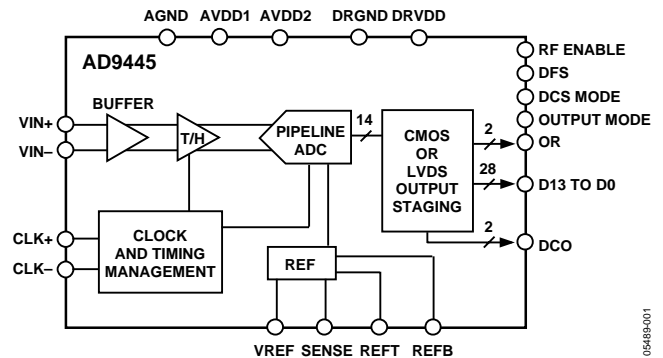

Figure 1.

Optional features allow users to implement various selectable operating conditions, including input range, data format select, high IF sampling mode, and output data mode.

The AD9445 is available in a Pb-free, 100-lead, surface-mount, plastic package (100-lead TQFP/EP) specified over the industrial temperature range  $-40^{\circ}\text{C}$  to  $+85^{\circ}\text{C}$ .

### PRODUCT HIGHLIGHTS

1. High performance: outstanding SFDR performance for IF sampling applications such as multicarrier, multimode 3G, and 4G cellular base station receivers.
2. Ease of use: on-chip reference and high input impedance track-and-hold with adjustable analog input range and an output clock simplifies data capture.
3. Packaged in a Pb-free, 100-lead TQFP/EP package.
4. Clock duty cycle stabilizer (DCS) maintains overall ADC performance over a wide range of clock pulse widths.
5. OR (out-of-range) outputs indicate when the signal is beyond the selected input range.
6. RF enable pin allows users to configure the device for optimum SFDR when sampling frequencies above 210 MHz (AD9445-125) or 240 MHz (AD9445-105).

**TABLE OF CONTENTS**

Features .....	1	Terminology .....	9
Applications.....	1	Pin Configurations and Function Descriptions .....	10
General Description .....	1	Equivalent Circuits.....	15
Functional Block Diagram .....	1	Typical Performance Characteristics .....	16
Product Highlights .....	1	Theory of Operation .....	24
Revision History .....	2	Analog Input and Reference Overview .....	24
Specifications.....	3	Clock Input Considerations.....	26
DC Specifications .....	3	Power Considerations.....	27
AC Specifications.....	4	Digital Outputs .....	27
Digital Specifications .....	6	Timing .....	27
Switching Specifications .....	6	Operational Mode Selection .....	28
Timing Diagrams.....	7	Evaluation Board .....	29
Absolute Maximum Ratings.....	8	Outline Dimensions .....	37
Thermal Resistance .....	8	Ordering Guide .....	37
ESD Caution.....	8		

**REVISION HISTORY****10/05—Revision 0: Initial Version**

## SPECIFICATIONS

### DC SPECIFICATIONS

AVDD1 = 3.3 V, AVDD2 = 5.0 V, DRVDD = 3.3 V, LVDS mode, specified minimum sampling rate, 2.0 V p-p differential input, internal trimmed reference (1.0 V mode), AIN = -1.0 dBFS, DCS on, unless otherwise noted. RF ENABLE = AGND.

Table 1.

Parameter	Temp	AD9445BSVZ-105			AD9445BSVZ-125			Unit
		Min	Typ	Max	Min	Typ	Max	
RESOLUTION	Full	14			14			Bits
ACCURACY		Guaranteed			Guaranteed			
No Missing Codes	Full							
Offset Error	Full	-7		+7	-7		+7	mV
	25°C		±3			±3		mV
Gain Error	Full	-3		+3	-3		+3	% FSR
	25°C	-2		+2	-2		+2	% FSR
Differential Nonlinearity (DNL) <sup>1</sup>	Full	-0.6	±0.25	+0.65	-0.6	±0.25	+0.65	LSB
		5			5			
Integral Nonlinearity (INL) <sup>1</sup>	25°C		±0.65			±0.8		LSB
	Full	-1.6		+1.6	-2		+2	LSB
VOLTAGE REFERENCE								
Output Voltage VREF = 1.0 V	Full	0.9	1.0	1.1	0.9	1.0	1.1	V
Load Regulation @ 1.0 mA	Full		±2			±2		mV
Reference Input Current (External VREF = 1.6 V)	Full							µA
INPUT REFERRED NOISE	25°C	1.0			1.0			LSB rms
ANALOG INPUT								
Input Span								
VREF = 1.6 V	Full		3.2			3.2		V p-p
VREF = 1.0 V	Full		2.0			2.0		V p-p
Internal Input Common-Mode Voltage	Full		3.5			3.5		V
External Input Common-Mode Voltage	Full	3.1		3.9	3.1		3.9	V
Input Resistance <sup>2</sup>	Full		1			1		kΩ
Input Capacitance <sup>2</sup>	Full		6			6		pF
POWER SUPPLIES								
Supply Voltage								
AVDD1	Full	3.14	3.3	3.46	3.14	3.3	3.46	V
AVDD2	Full	4.75	5.0	5.25	4.75	5.0	5.25	V
DRVDD—LVDS Outputs	Full	3.0		3.6	3.0		3.6	V
DRVDD—CMOS Outputs	Full	3.0	3.3	3.6	3.0	3.3	3.6	V
Supply Current <sup>1</sup>								
AVDD1	Full		335	364		384	424	mA
AVDD2 <sup>1, 3</sup>	Full		169	196		172	199	mA
I <sub>DRVDD</sub> <sup>1</sup> —LVDS Outputs	Full		63	78		63	78	mA
I <sub>DRVDD</sub> <sup>1</sup> —CMOS Outputs	Full		14			14		mA
PSRR								
Offset	Full		1			1		mV/V
Gain	Full		0.2			0.2		%/V
POWER CONSUMPTION								
LVDS Outputs	Full		2.2	2.4		2.3	2.6	W
CMOS Outputs (DC Input)	Full		2.0			2.1		W

<sup>1</sup> Measured at the maximum clock rate,  $f_{IN} = 15$  MHz, full-scale sine wave, with a 100 Ω differential termination on each pair of output bits for LVDS output mode and approximately 5 pF loading on each output bit for CMOS output mode.

<sup>2</sup> Input capacitance or resistance refers to the effective impedance between one differential input pin and AGND. Refer to Figure 6 for the equivalent analog input structure.

<sup>3</sup> For RF ENABLE = AVDD1, I<sub>AVDD2</sub> increases by ~30 mA, which increases power dissipation.

# AD9445

## AC SPECIFICATIONS

AVDD1 = 3.3 V, AVDD2 = 5.0 V, DRVDD = 3.3 V, LVDS mode, specified minimum sample rate, 2.0 V p-p differential input, internal trimmed reference (1.0 V mode),  $A_{IN} = -1.0$  dBFS, DCS on, RF ENABLE = ground, unless otherwise noted.

Table 2.

Parameter	Temp	AD9445BSVZ-105			AD9445BSVZ-125			Unit
		Min	Typ	Max	Min	Typ	Max	
SIGNAL-TO-NOISE RATIO (SNR)								
$f_{IN} = 10$ MHz	25°C		74.3			74.1		dB
$f_{IN} = 30$ MHz	25°C	73.3	74.3		72.9	73.8		dB
	Full	73			72.5			dB
$f_{IN} = 170$ MHz	25°C	72.9	73.6		72.3	73.2		dB
$f_{IN} = 225$ MHz <sup>1</sup>	25°C	72.2	73		72	72.9		dB
	Full	72.2			71.4			dB
$f_{IN} = 300$ MHz <sup>2</sup>	25°C	71.4	72.1		71.3	72		dB
$f_{IN} = 400$ MHz <sup>2</sup>	25°C		71			71		dB
$f_{IN} = 450$ MHz <sup>2</sup>	25°C		70.5			70.5		dB
$f_{IN} = 10$ MHz (3.2 V p-p Input)	25°C		77.6			77.3		dB
$f_{IN} = 30$ MHz (3.2 V p-p Input)	25°C		77.5			77.3		dB
$f_{IN} = 170$ MHz (3.2 V p-p Input)	25°C		76			76		dB
$f_{IN} = 225$ MHz (3.2 V p-p Input) <sup>1</sup>	25°C		75.3			75.4		dB
$f_{IN} = 300$ MHz (3.2 V p-p Input) <sup>2</sup>	25°C		73.7			73.5		dB
SIGNAL-TO-NOISE AND DISTORTION (SINAD)								
$f_{IN} = 10$ MHz	25°C		74.2			73.9		dB
$f_{IN} = 30$ MHz	25°C	73.2	74.2		72.8	73.7		dB
	Full	72.8			72.3			dB
$f_{IN} = 170$ MHz	25°C	72.3	73.3		72.4	73.0		dB
$f_{IN} = 225$ MHz <sup>1</sup>	25°C	71.4	72.5		71.9	72.5		dB
	Full	71.3			70.7			dB
$f_{IN} = 300$ MHz <sup>2</sup>	25°C	70.2	71.7		69.3	71.5		dB
$f_{IN} = 400$ MHz <sup>2</sup>	25°C		67.2			66.3		dB
$f_{IN} = 450$ MHz <sup>2</sup>	25°C		65.2			64.3		dB
$f_{IN} = 10$ MHz (3.2 V p-p Input)	25°C		77.4			76.9		dB
$f_{IN} = 30$ MHz (3.2 V p-p Input)	25°C		77.3			76.8		dB
$f_{IN} = 170$ MHz (3.2 V p-p Input)	25°C		75.7			75.4		dB
$f_{IN} = 225$ MHz (3.2 V p-p Input) <sup>1</sup>	25°C		75.1			75.2		dB
$f_{IN} = 300$ MHz (3.2 V p-p Input) <sup>2</sup>	25°C		72.5			71.8		dB
EFFECTIVE NUMBER OF BITS (ENOB)								
$f_{IN} = 10$ MHz	25°C		12.2			12.2		Bits
$f_{IN} = 30$ MHz	25°C		12.2			12.1		Bits
$f_{IN} = 170$ MHz	25°C		12.1			12.0		Bits
$f_{IN} = 225$ MHz <sup>1</sup>	25°C		12.0			12.0		Bits
$f_{IN} = 300$ MHz <sup>2</sup>	25°C		11.8			11.8		Bits
$f_{IN} = 400$ MHz <sup>2</sup>	25°C		11.7			11.7		Bits
$f_{IN} = 450$ MHz <sup>2</sup>	25°C		11.6			11.6		Bits

Parameter	Temp	AD9445BSVZ-105			AD9445BSVZ-125			Unit
		Min	Typ	Max	Min	Typ	Max	
SPURIOUS-FREE DYNAMIC RANGE (SFDR, Second or Third Harmonic)								
$f_{IN} = 10 \text{ MHz}$	25°C		95			95		dBc
$f_{IN} = 30 \text{ MHz}$	25°C	84	92		85	94		dBc
	Full	83			82			dBc
$f_{IN} = 170 \text{ MHz}$	25°C	82	94		80	91		dBc
$f_{IN} = 225 \text{ MHz}^1$	25°C	76	87		83	88		dBc
	Full	75			75			dBc
$f_{IN} = 300 \text{ MHz}^2$	25°C	76	87		75	87		dBc
$f_{IN} = 400 \text{ MHz}^2$	25°C		75			73		dBc
$f_{IN} = 450 \text{ MHz}^2$	25°C		70			69		dBc
$f_{IN} = 10 \text{ MHz (3.2 V p-p Input)}$	25°C		92			92		dBc
$f_{IN} = 30 \text{ MHz (3.2 V p-p Input)}$	25°C		88			91		dBc
$f_{IN} = 170 \text{ MHz (3.2 V p-p Input)}$	25°C		86			86		dBc
$f_{IN} = 225 \text{ MHz (3.2 V p-p Input)}^1$	25°C		81			80		dBc
$f_{IN} = 300 \text{ MHz (3.2 V p-p Input)}^2$	25°C		77			76		dBc
WORST SPUR EXCLUDING SECOND OR THIRD HARMONICS								
$f_{IN} = 10 \text{ MHz}$	25°C		-97			-97		dBc
$f_{IN} = 30 \text{ MHz}$	25°C		-99	-90		-98	-89	dBc
	Full			-90			-88	dBc
$f_{IN} = 170 \text{ MHz}$	25°C		-99	-92		-93	-85	dBc
$f_{IN} = 225 \text{ MHz}^1$	25°C		-94	-88		-94	-84	dBc
	Full			-86			-80	dBc
$f_{IN} = 300 \text{ MHz}^2$	25°C		-97	-90		-92	-82	dBc
$f_{IN} = 400 \text{ MHz}^2$	25°C		-93			-93		dBc
$f_{IN} = 450 \text{ MHz}^2$	25°C		-82			-87		dBc
$f_{IN} = 10 \text{ MHz (3.2 V p-p Input)}$	25°C		-97			-95		dBc
$f_{IN} = 30 \text{ MHz (3.2 V p-p Input)}$	25°C		-97			-95		dBc
$f_{IN} = 170 \text{ MHz (3.2 V p-p Input)}$	25°C		-97			-95		dBc
$f_{IN} = 225 \text{ MHz (3.2 V p-p Input)}^1$	25°C		-95			-94		dBc
$f_{IN} = 300 \text{ MHz (3.2 V p-p Input)}^2$	25°C		-93			-91		dBc
TWO-TONE SFDR								
$f_{IN} = 30.3 \text{ MHz @ } -7 \text{ dBFS,}$ $31.3 \text{ MHz @ } -7 \text{ dBFS}$	25°C		102			102		dBFS
$f_{IN} = 170.3 \text{ MHz @ } -7 \text{ dBFS,}$ $171.3 \text{ MHz @ } -7 \text{ dBFS}$	25°C		92			91		dBFS
ANALOG BANDWIDTH	Full		615			615		MHz

<sup>1</sup> RF ENABLE = low (AGND) for AD9445-105; RF ENABLE = high (AVDD1) for AD9445-125.

<sup>2</sup> RF ENABLE = high (AVDD1).

# AD9445

## DIGITAL SPECIFICATIONS

AVDD1 = 3.3 V, AVDD2 = 5.0 V, DRVDD = 3.3 V, R<sub>LVDS\_BIAS</sub> = 3.74 kΩ, unless otherwise noted.

Table 3.

Parameter	Temp	AD9445BSVZ-105			AD9445BSVZ-125			Unit
		Min	Typ	Max	Min	Typ	Max	
CMOS LOGIC INPUTS (DFS, DCS MODE, OUTPUT MODE)								
High Level Input Voltage	Full	2.0			2.0			V
Low Level Input Voltage	Full			0.8			0.8	V
High Level Input Current	Full			200			200	μA
Low Level Input Current	Full	-10		+10	-10		+10	μA
Input Capacitance	Full		2			2		pF
DIGITAL OUTPUT BITS—CMOS MODE (D0 to D13, OTR) <sup>1</sup>								
DRVDD = 3.3 V								
High Level Output Voltage	Full	3.25			3.25			V
Low Level Output Voltage	Full			0.2			0.2	V
DIGITAL OUTPUT BITS—LVDS MODE (D0 to D13, OTR)								
V <sub>OD</sub> Differential Output Voltage <sup>2</sup>	Full	247		545	247		545	mV
V <sub>OS</sub> Output Offset Voltage	Full	1.125		1.375	1.125		1.375	V
CLOCK INPUTS (CLK+, CLK-)								
Differential Input Voltage	Full	0.2			0.2			V
Common-Mode Voltage	Full	1.3	1.5	1.6	1.3	1.5	1.6	V
Differential Input Resistance	Full	1.1	1.4	1.7	1.1	1.4	1.7	kΩ
Differential Input Capacitance	Full		2			2		pF

<sup>1</sup> Output voltage levels measured with 5 pF load on each output.

<sup>2</sup> LVDS R<sub>TERM</sub> = 100 Ω.

## SWITCHING SPECIFICATIONS

AVDD1 = 3.3 V, AVDD2 = 5.0 V, DRVDD = 3.3 V, unless otherwise noted.

Table 4.

Parameter	Temp	AD9445BSVZ-105			AD9445BSVZ-125			Unit
		Min	Typ	Max	Min	Typ	Max	
CLOCK INPUT PARAMETERS								
Maximum Conversion Rate	Full	105			125			MSPS
Minimum Conversion Rate	Full			10			10	MSPS
CLK Period	Full	9.5			8.0			ns
CLK Pulse Width High <sup>1</sup> (t <sub>CLKH</sub> )	Full	3.8			3.2			ns
CLK Pulse Width Low <sup>1</sup> (t <sub>CLKL</sub> )	Full	3.8			3.2			ns
DATA OUTPUT PARAMETERS								
Output Propagation Delay—CMOS (t <sub>PD</sub> ) <sup>2</sup> (Dx, DCO+)	Full		3.35			3.35		ns
Output Propagation Delay—LVDS (t <sub>PD</sub> ) <sup>3</sup> (DX+), (t <sub>CPD</sub> ) <sup>3</sup> (DCO+)	Full	2.1	3.6	4.8	2.3	3.6	4.8	ns
Pipeline Delay (Latency)	Full		13			13		Cycles
Aperture Delay (t <sub>A</sub> )	Full							ns
Aperture Uncertainty (Jitter, t <sub>J</sub> )	Full		60			60		fsec rms

<sup>1</sup> With duty cycle stabilizer (DCS) enabled.

<sup>2</sup> Output propagation delay is measured from clock 50% transition to data 50% transition with 5 pF load.

<sup>3</sup> LVDS R<sub>TERM</sub> = 100 Ω. Measured from the 50% point of the rising edge of CLK+ to the 50% point of the data transition.

TIMING DIAGRAMS

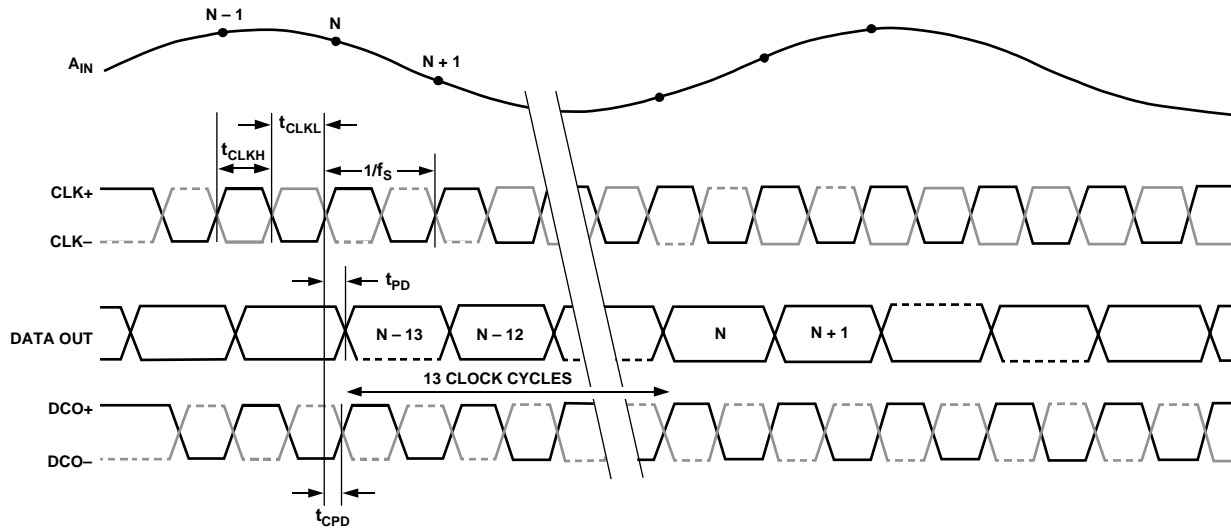

05489-002

Figure 2. LVDS Mode Timing Diagram

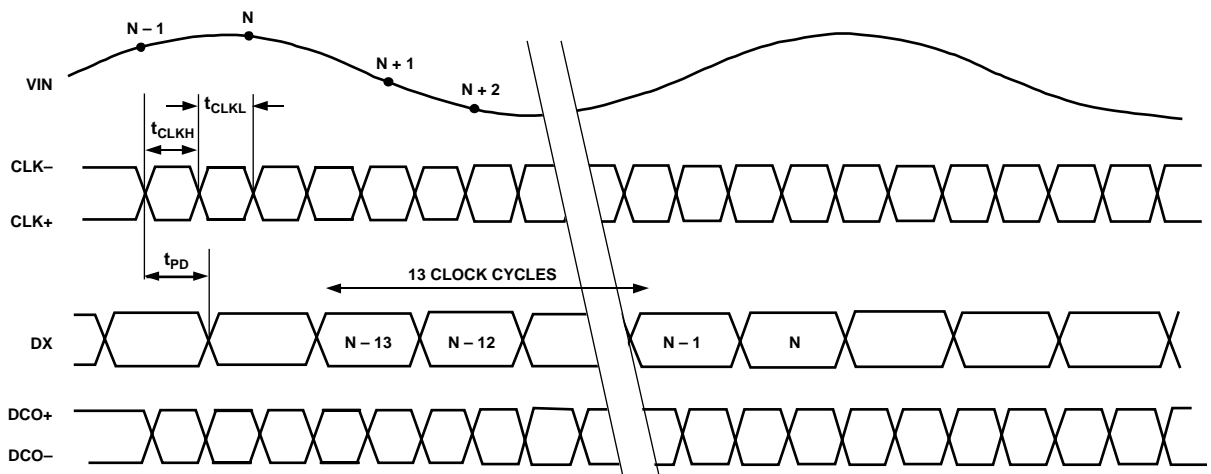

05489-003

Figure 3. CMOS Timing Diagram

## ABSOLUTE MAXIMUM RATINGS

Table 5.

Parameter	With Respect To	Rating
<b>ELECTRICAL</b>		
AVDD1	AGND	-0.3 V to +4 V
AVDD2	AGND	-0.3 V to +6 V
DRVDD	DGND	-0.3 V to +4 V
AGND	DGND	-0.3 V to +0.3 V
AVDD1	DRVDD	-4 V to +4 V
AVDD2	DRVDD	-4 V to +6 V
AVDD2	AVDD1	-4 V to +6 V
D0± to D13±	DGND	-0.3 V to DRVDD + 0.3 V
CLK+/CLK-	AGND	-0.3 V to AVDD1 + 0.3 V
OUTPUT MODE, DCS MODE, DFS, SFDR, RF ENABLE	AGND	-0.3 V to AVDD1 + 0.3 V
VIN+, VIN-	AGND	-0.3 V to AVDD2 + 0.3 V
VREF	AGND	-0.3 V to AVDD1 + 0.3 V
SENSE	AGND	-0.3 V to AVDD1 + 0.3 V
REFT, REFB	AGND	-0.3 V to AVDD1 + 0.3 V
<b>ENVIRONMENTAL</b>		
Storage Temperature Range		-65°C to +125°C
Operating Temperature Range		-40°C to +85°C
Lead Temperature (Soldering 10 sec)		300°C
Junction Temperature		150°C

Stresses above those listed under Absolute Maximum Ratings may cause permanent damage to the device. This is a stress rating only; functional operation of the device at these or any other conditions above those indicated in the operational section of this specification is not implied. Exposure to absolute maximum rating conditions for extended periods may affect device reliability.

### THERMAL RESISTANCE

The heat sink of the AD9445 package must be soldered to ground.

Table 6.

Package Type	$\theta_{JA}$	$\theta_{JB}$	$\theta_{JC}$	Unit
100-lead TQFP/EP	19.8	8.3	2	°C/W

Typical  $\theta_{JA}$  = 19.8°C/W (heat sink soldered) for multilayer board in still air.

Typical  $\theta_{JB}$  = 8.3°C/W (heat sink soldered) for multilayer board in still air.

Typical  $\theta_{JC}$  = 2°C/W (junction to exposed heat sink) represents the thermal resistance through heat sink path.

Airflow increases heat dissipation, effectively reducing  $\theta_{JA}$ . Also, more metal directly in contact with the package leads from metal traces through holes, ground, and power planes reduces the  $\theta_{JA}$ . It is required that the exposed heat sink be soldered to the ground plane.

### ESD CAUTION

ESD (electrostatic discharge) sensitive device. Electrostatic charges as high as 4000 V readily accumulate on the human body and test equipment and can discharge without detection. Although this product features proprietary ESD protection circuitry, permanent damage may occur on devices subjected to high energy electrostatic discharges. Therefore, proper ESD precautions are recommended to avoid performance degradation or loss of functionality.





## TERMINOLOGY

### Analog Bandwidth (Full Power Bandwidth)

The analog input frequency at which the spectral power of the fundamental frequency (as determined by the FFT analysis) is reduced by 3 dB.

### Aperture Delay ( $t_A$ )

The delay between the 50% point of the rising edge of the clock and the instant at which the analog input is sampled.

### Aperture Uncertainty (Jitter, $t_j$ )

The sample-to-sample variation in aperture delay.

### Clock Pulse Width and Duty Cycle

Pulse width high is the minimum amount of time that the clock pulse should be left in the Logic 1 state to achieve rated performance. Pulse width low is the minimum time the clock pulse should be left in the low state. At a given clock rate, these specifications define an acceptable clock duty cycle.

### Differential Nonlinearity (DNL, No Missing Codes)

An ideal ADC exhibits code transitions that are exactly 1 LSB apart. DNL is the deviation from this ideal value. Guaranteed no missing codes to 14-bit resolution indicates that all 16,384 codes must be present over all operating ranges.

### Effective Number of Bits (ENOB)

The effective number of bits for a sine wave input at a given input frequency can be calculated directly from its measured SINAD using the following formula:

$$ENOB = \frac{(SINAD - 1.76)}{6.02}$$

### Gain Error

The first code transition should occur at an analog value of  $\frac{1}{2}$  LSB above negative full scale. The last transition should occur at an analog value of  $1\frac{1}{2}$  LSB below the positive full scale. Gain error is the deviation of the actual difference between first and last code transitions and the ideal difference between first and last code transitions.

### Integral Nonlinearity (INL)

The deviation of each individual code from a line drawn from negative full scale through positive full scale. The point used as negative full scale occurs  $\frac{1}{2}$  LSB before the first code transition. Positive full scale is defined as a level  $1\frac{1}{2}$  LSB beyond the last code transition. The deviation is measured from the middle of each particular code to the true straight line.

### Maximum Conversion Rate

The clock rate at which parametric testing is performed.

### Minimum Conversion Rate

The clock rate at which the SNR of the lowest analog signal frequency drops by no more than 3 dB below the guaranteed limit.

### Offset Error

The major carry transition should occur for an analog value of  $\frac{1}{2}$  LSB below  $V_{IN+} = V_{IN-}$ . Offset error is defined as the deviation of the actual transition from that point.

### Out-of-Range Recovery Time

The time it takes for the ADC to reacquire the analog input after a transition from 10% above positive full scale to 10% above negative full scale, or from 10% below negative full scale to 10% below positive full scale.

### Output Propagation Delay ( $t_{PD}$ )

The delay between the clock rising edge and the time when all bits are within valid logic levels.

### Power-Supply Rejection Ratio

The change in full scale from the value with the supply at the minimum limit to the value with the supply at the maximum limit.

### Signal-to-Noise and Distortion (SINAD)

The ratio of the rms input signal amplitude to the rms value of the sum of all other spectral components below the Nyquist frequency, including harmonics but excluding dc.

### Signal-to-Noise Ratio (SNR)

The ratio of the rms input signal amplitude to the rms value of the sum of all other spectral components below the Nyquist frequency, excluding the first six harmonics and dc.

### Spurious-Free Dynamic Range (SFDR)

The ratio of the rms signal amplitude to the rms value of the peak spurious spectral component. The peak spurious component may be a harmonic. SFDR can be reported in dBc (that is, degrades as signal level is lowered) or dBFS (always related back to converter full scale).

### Temperature Drift

The temperature drift for offset error and gain error specifies the maximum change from the initial (25°C) value to the value at  $T_{MIN}$  or  $T_{MAX}$ .

### Total Harmonic Distortion (THD)

The ratio of the rms input signal amplitude to the rms value of the sum of the first six harmonic components.

### Two-Tone SFDR

The ratio of the rms value of either input tone to the rms value of the peak spurious component. The peak spurious component may or may not be an IMD product.

## PIN CONFIGURATIONS AND FUNCTION DESCRIPTIONS

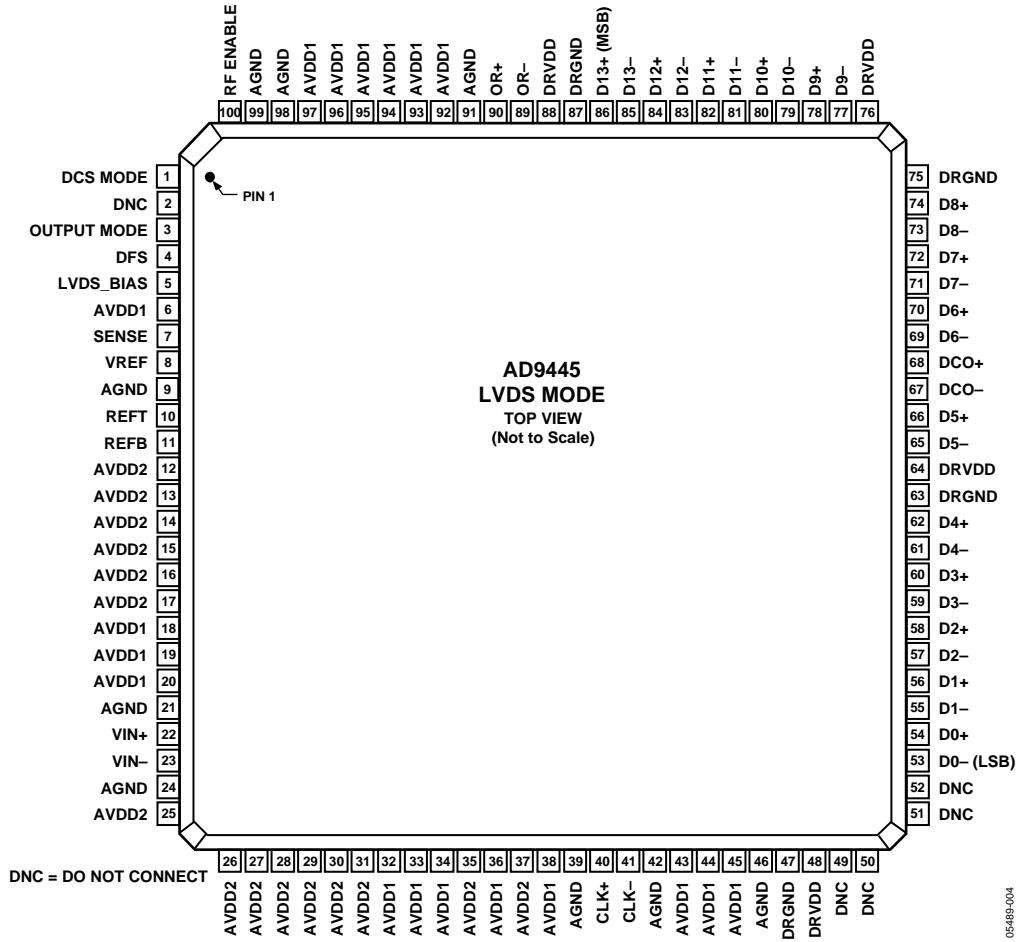

Figure 4. 100-Lead TQFP/EP Pin Configuration in LVDS Mode

05489-004

Table 7. Pin Function Descriptions—100-Lead TQFP/EP in LVDS Mode

Pin No.	Mnemonic	Description
1	DCS MODE	Clock Duty Cycle Stabilizer (DCS) Control Pin. CMOS compatible. DCS = low (AGND) to enable DCS (recommended); DCS = high (AVDD1) to disable DCS.
2, 49 to 52	DNC	Do Not Connect. These pins should float.
3	OUTPUT MODE	CMOS-Compatible Output Logic Mode Control Pin. OUTPUT MODE = 0 for CMOS mode; OUTPUT MODE = 1 (AVDD1) for LVDS outputs.
4	DFS	Data Format Select Pin. CMOS control pin that determines the format of the output data. DFS = high (AVDD1) for twos complement; DFS = low (ground) for offset binary format.
5	LVDS_BIAS	Set Pin for LVDS Output Current. Place 3.7 k $\Omega$ resistor terminated to DRGND.
6, 18 to 20, 32 to 34, 36, 38, 43 to 45, 92 to 97	AVDD1	3.3 V ( $\pm 5\%$ ) Analog Supply.
7	SENSE	Reference Mode Selection. Connect to AGND for internal 1 V reference; connect to AVDD1 for external reference.
8	VREF	1.0 V Reference I/O. Function dependent on SENSE and external programming resistors. Decouple to ground with 0.1 $\mu$ F and 10 $\mu$ F capacitors.
9, 21, 24, 39, 42, 46, 91, 98, 99, Exposed Heat Sink	AGND	Analog Ground. The exposed heat sink on the bottom of the package must be connected to AGND.
10	REFT	Differential Reference Output. Decoupled to ground with 0.1 $\mu$ F capacitor and to REFB (Pin 14) with 0.1 $\mu$ F and 10 $\mu$ F capacitors.
11	REFB	Differential Reference Output. Decoupled to ground with a 0.1 $\mu$ F capacitor and to REFT (Pin 13) with 0.1 $\mu$ F and 10 $\mu$ F capacitors.
12 to 17, 25 to 31, 35, 37	AVDD2	5.0 V Analog Supply ( $\pm 5\%$ ).
22	VIN+	Analog Input—True.
23	VIN-	Analog Input—Complement.
40	CLK+	Clock Input—True.
41	CLK-	Clock Input—Complement.
47, 63, 75, 87	DRGND	Digital Output Ground.
48, 64, 76, 88	DRVDD	3.3 V Digital Output Supply (3.0 V to 3.6 V).
53	D0- (LSB)	D0 Complement Output Bit (LVDS Levels).
54	D0+	D0 True Output Bit.
55	D1-	D1 Complement Output Bit.
56	D1+	D1 True Output Bit.
57	D2-	D2 Complement Output Bit.
58	D2+	D2 True Output Bit.
59	D3-	D3 Complement Output Bit.
60	D3+	D3 True Output Bit.
61	D4-	D4 Complement Output Bit.
62	D4+	D4 True Output Bit.
65	D5-	D5 Complement Output Bit.
66	D5+	D5 True Output Bit.
67	DCO-	Data Clock Output—Complement.
68	DCO+	Data Clock Output—True.
69	D6-	D6 Complement Output Bit.
70	D6+	D6 True Output Bit.
71	D7-	D7 Complement Output Bit.
72	D7+	D7 True Output Bit.
73	D8-	D8 Complement Output Bit.
74	D8+	D8 True Output Bit.
77	D9-	D9 Complement Output Bit.
78	D9+	D9 True Output Bit.
79	D10-	D10 Complement Output Bit.
80	D10+	D10 True Output Bit.
81	D11-	D11 Complement Output Bit.
82	D11+	D11 True Output Bit.

# AD9445

Pin No.	Mnemonic	Description
83	D12-	D12 Complement Output Bit.
84	D12+	D12 True Output Bit.
85	D13-	D13 Complement Output Bit.
86	D13+ (MSB)	D13 True Output Bit.
89	OR-	Out-of-Range Complement Output Bit.
90	OR+	Out-of-Range True Output Bit.
100	RF ENABLE	RF ENABLE Control Pin. CMOS-compatible control pin to optimize the configuration of the AD9445 analog front end. Connecting RF ENABLE to AGND optimizes SFDR performance for applications with analog input frequencies <210 MHz for 125 MSPS speed grade and <230 MHz for the 105 MSPS speed grade. For applications with analog inputs >225 MHz for the 125 MSPS speed grade and >230 MHz for the 105 MSPS speed grade, this pin should be connected to AVDD1 for optimum SFDR performance. Power dissipation from AVDD2 increases by 150 mW to 200 mW.

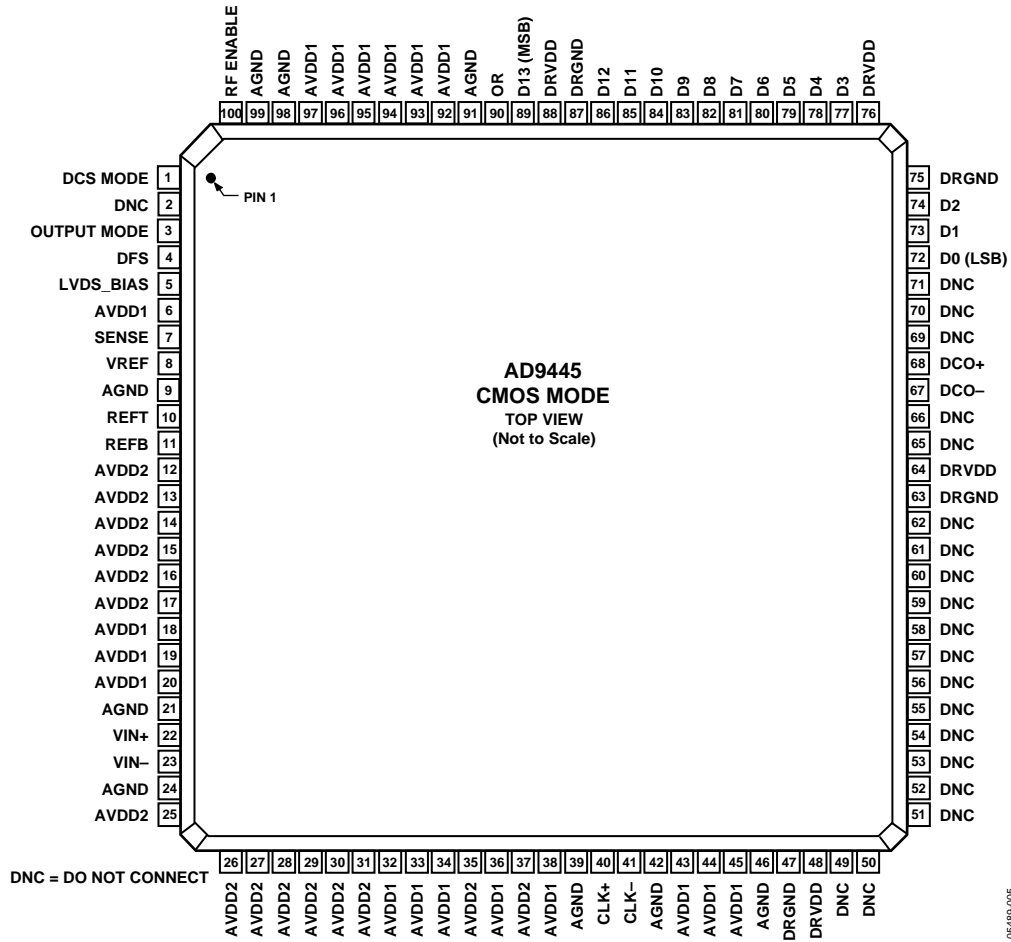

Figure 5. 100-Lead TQFP/EP Pin Configuration in CMOS Mode

05489-005

Table 8. Pin Function Descriptions—100-Lead TQFP/EP in CMOS Mode

Pin No.	Mnemonic	Description
1	DCS MODE	Clock Duty Cycle Stabilizer (DCS) Control Pin. CMOS compatible. DCS = low (AGND) to enable DCS (recommended); DCS = high (AVDD1) to disable DCS.
2, 49 to 62, 65 to 66, 69 to 71	DNC	Do Not Connect. These pins should float.
3	OUTPUT MODE	CMOS-Compatible Output Logic Mode Control Pin. OUTPUT MODE = 0 for CMOS mode; OUTPUT MODE = 1 (AVDD1) for LVDS outputs.
4	DFS	Data Format Select Pin. CMOS control pin that determines the format of the output data. DFS = high (AVDD1) for twos complement; DFS = low (ground) for offset binary format.
5	LVDS_BIAS	Set Pin for LVDS Output Current. Place 3.7 k $\Omega$ resistor terminated to DRGND.
6, 18 to 20, 32 to 34, 36, 38, 43 to 45, 92 to 97	AVDD1	3.3 V ( $\pm 5\%$ ) Analog Supply.
7	SENSE	Reference Mode Selection. Connect to AGND for internal 1 V reference; connect to AVDD1 for external reference.
8	VREF	1.0 V Reference I/O. Function dependent on SENSE and external programming resistors. Decouple to ground with 0.1 $\mu$ F and 10 $\mu$ F capacitors.
9, 21, 24, 39, 42, 46, 91, 98, 99, Exposed Heat Sink	AGND	Analog Ground. The exposed heat sink on the bottom of the package must be connected to AGND.
10	REFT	Differential Reference Output. Decoupled to ground with 0.1 $\mu$ F capacitor and to REFB (Pin 14) with 0.1 $\mu$ F and 10 $\mu$ F capacitors.
11	REFB	Differential Reference Output. Decoupled to ground with a 0.1 $\mu$ F capacitor and to REFT (Pin 13) with 0.1 $\mu$ F and 10 $\mu$ F capacitors.
12 to 17, 25 to 31, 35, 37	AVDD2	5.0 V Analog Supply ( $\pm 5\%$ ).
22	VIN+	Analog Input—True.
23	VIN-	Analog Input—Complement.
40	CLK+	Clock Input—True.
41	CLK-	Clock Input—Complement.
47, 63, 75, 87	DRGND	Digital Output Ground.
48, 64, 76, 88	DRVDD	3.3 V Digital Output Supply (3.0 V to 3.6 V).
67	DCO-	Data Clock Output—Complement.
68	DCO+	Data Clock Output—True.
72	D0 (LSB)	D0 True Output Bit (CMOS levels).
73	D1	D1 True Output Bit.
74	D2	D2 True Output Bit.
77	D3	D3 True Output Bit.
78	D4	D4 True Output Bit.
79	D5	D5 True Output Bit.
80	D6	D6 True Output Bit.
81	D7	D7 True Output Bit.
82	D8	D8 True Output Bit.
83	D9	D9 True Output Bit.
84	D10	D10 True Output Bit.
85	D11	D11 True Output Bit.
86	D12	D12 True Output Bit.
89	D13 (MSB)	D13 True Output Bit.
90	OR	Out-of-Range True Output Bit.
100	RF ENABLE	RF ENABLE CMOS-compatible Control Pin. Optimizes the configuration of the analog front end. Connecting RF ENABLE to AGND optimizes SFDR performance for applications with analog input frequencies <210 MHz for 125 MSPS speed grade and <230 MHz for the 105 MSPS speed grade. For applications with analog inputs >225 MHz for the 125 MSPS speed grade and >230 MHz for the 105 MSPS speed grade, this pin should be connected to AVDD1 for optimum SFDR. Power dissipation from AVDD2 increases by 150 mW to 200 mW.

# EQUIVALENT CIRCUITS

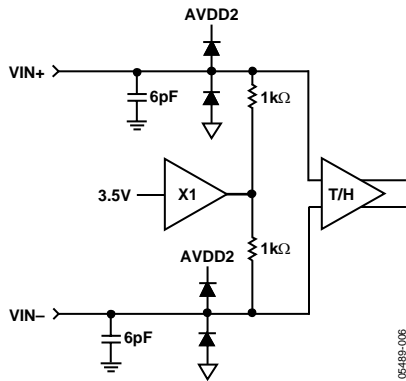

Figure 6. Equivalent Analog Input Circuit

05489-006

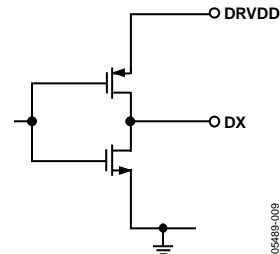

Figure 9. Equivalent CMOS Digital Output Circuit

05489-009

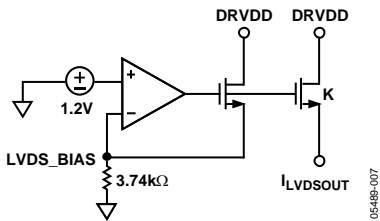

Figure 7. Equivalent LVDS\_BIAS Circuit

05489-007

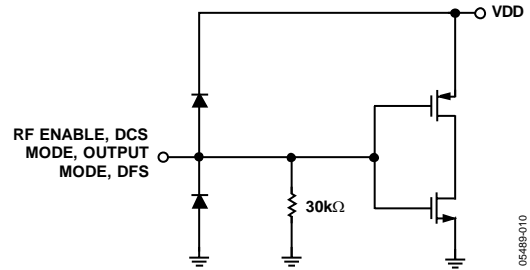

Figure 10. Equivalent Digital Input Circuit, DFS, DCS MODE, OUTPUT MODE

05489-010

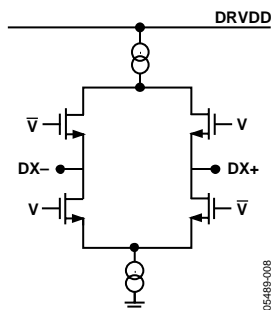

Figure 8. Equivalent LVDS Digital Output Circuit

05489-008

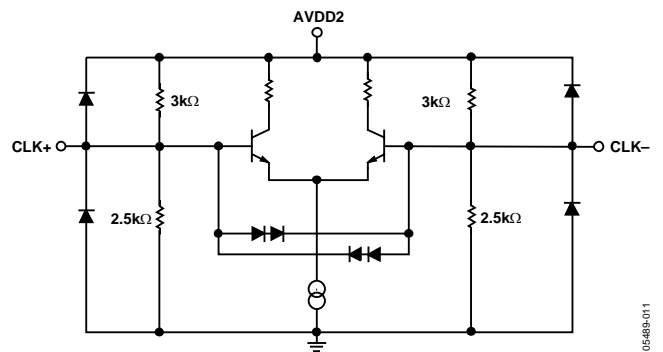

Figure 11. Equivalent Sample Clock Input Circuit

05489-011

## TYPICAL PERFORMANCE CHARACTERISTICS

AVDD1 = 3.3 V, AVDD2 = 5.0 V, DRVDD = 3.3 V, rated sample rate, LVDS mode, DCS enabled,  $T_A = 25^\circ\text{C}$ , 2.0 V p-p differential input, AIN = -1.0 dBFS, internal trimmed reference (nominal VREF = 1.0 V), unless otherwise noted.

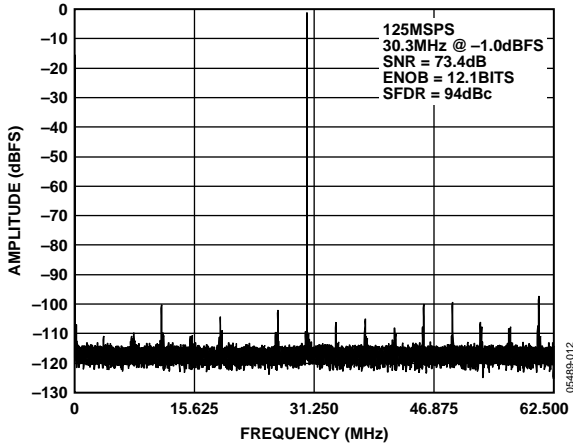

Figure 12. AD9445-125 64k Point Single-Tone FFT/125 MSPS/30.3 MHz

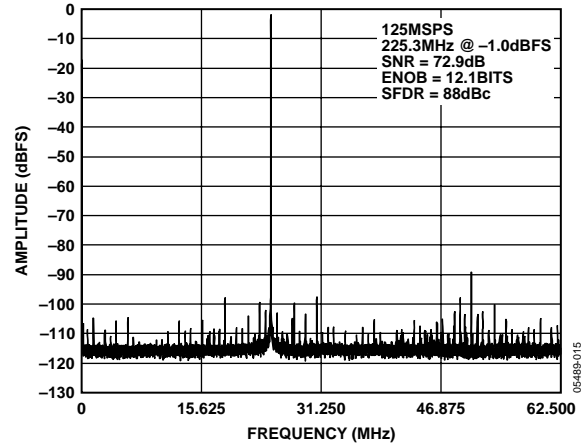

Figure 15. AD9445-125 64k Point Single-Tone FFT/125 MSPS/225.3 MHz

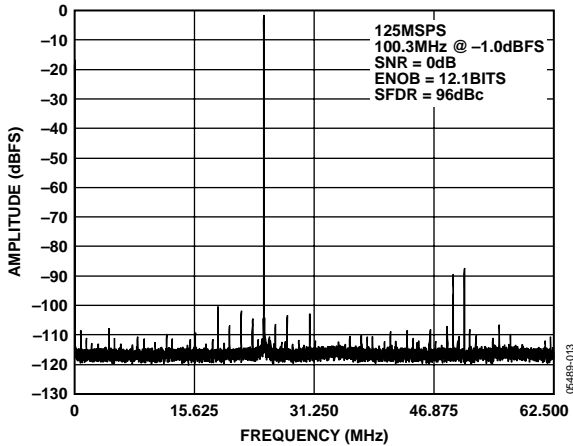

Figure 13. AD9445-125 64k Point Single-Tone FFT/125 MSPS/100.3 MHz

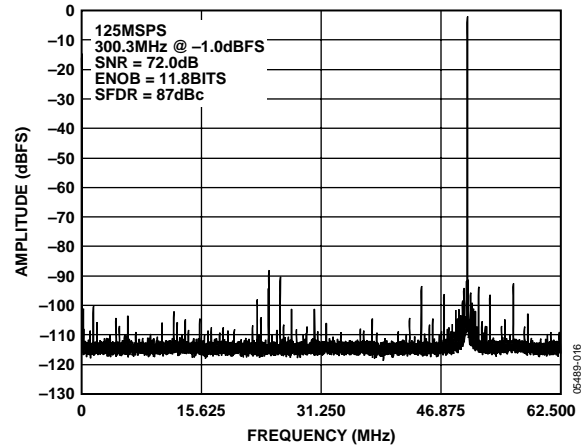

Figure 16. AD9445-125 64k Point Single-Tone FFT/125 MSPS/300.3 MHz

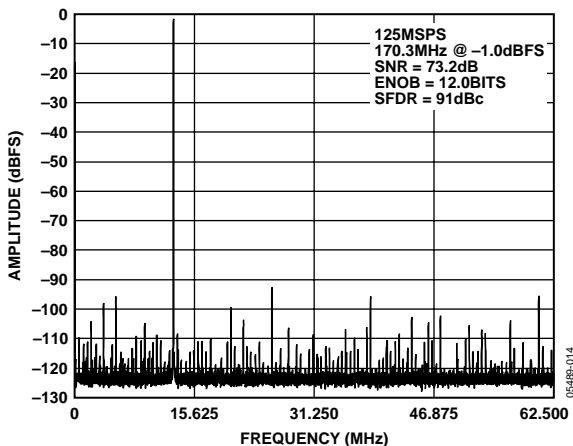

Figure 14. AD9445-125 64k Point Single-Tone FFT/125 MSPS/170.3 MHz

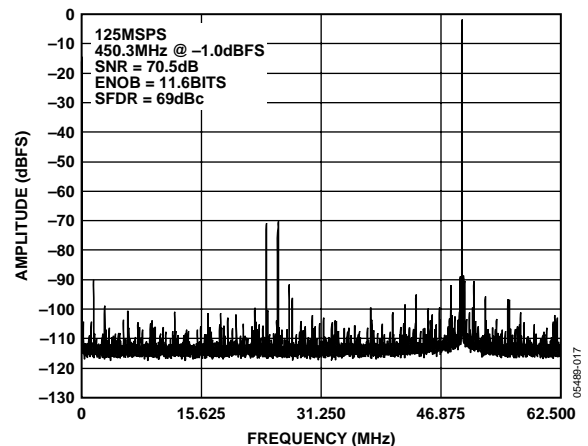

Figure 17. AD9445-125 64k Point Single-Tone FFT/125 MSPS/450.3 MHz



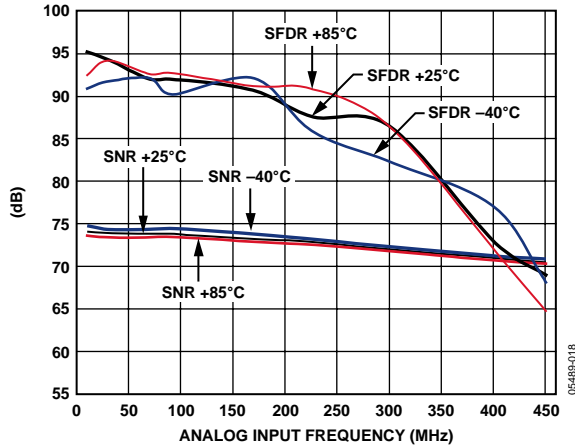

Figure 18. AD9445-125 SNR/SFDR vs. Analog Input Frequency, 125 MSPS, 2.0 V p-p Input Range

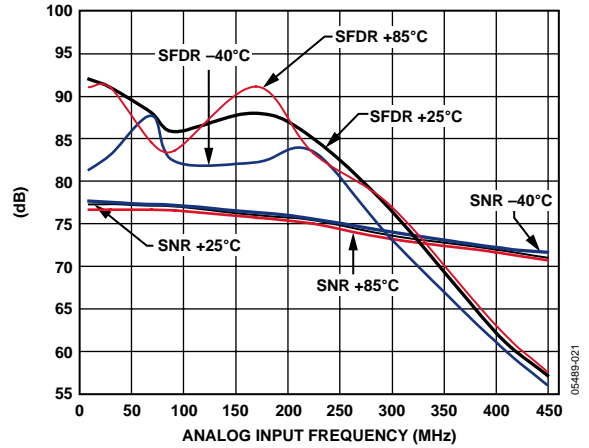

Figure 21. AD9445-125 SNR/SFDR vs. Analog Input Frequency, 125 MSPS, 3.2 V p-p Input Range

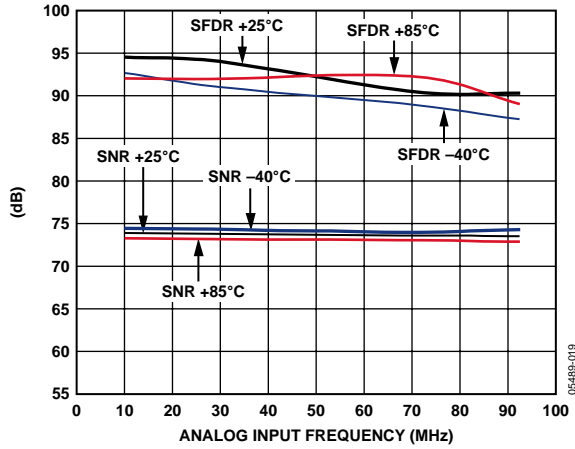

Figure 19. AD9445-125 SNR/SFDR vs. Analog Input Frequency, 3.2 V p-p Input Range, 125 MSPS, CMOS Output Mode

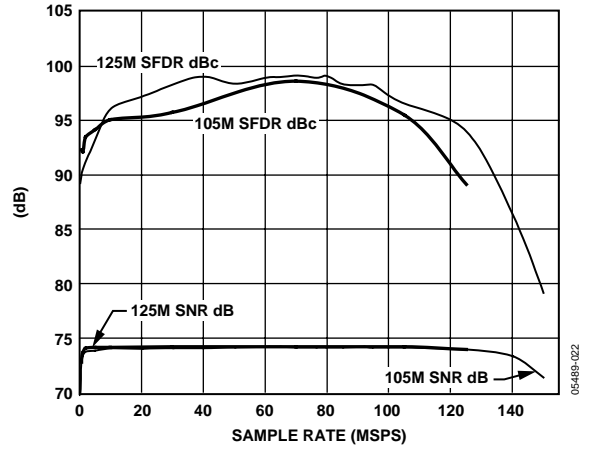

Figure 22. AD9445 Single-Tone SNR/SFDR vs. Sample Rate 2.3 MHz

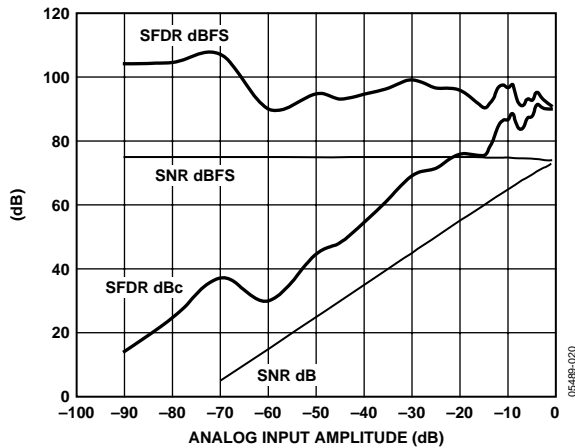

Figure 20. AD9445-125 SNR/SFDR vs. Analog Input Level, 125 MSPS/225.3 MHz

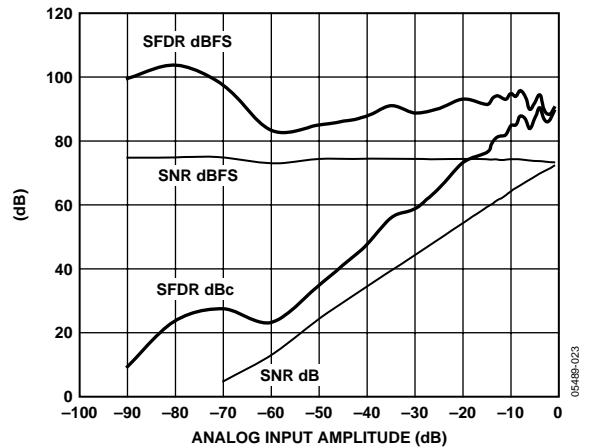

Figure 23. AD9445-125 SNR/SFDR vs. Analog Input Level, 125 MSPS/225.3 MHz, CMOS Output Mode

# AD9445

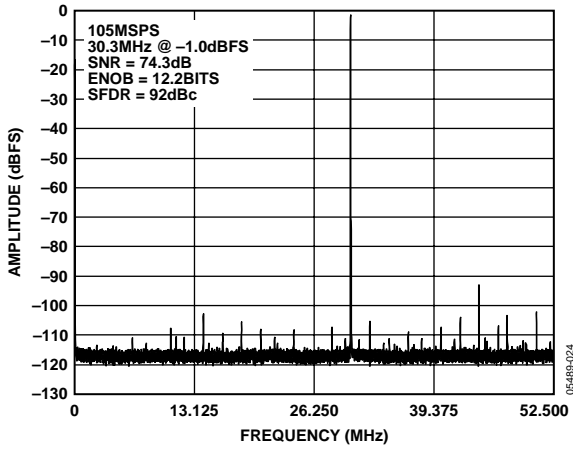

Figure 24. AD9445-105 64k Point Single-Tone FFT/105 MSPS/30.3 MHz

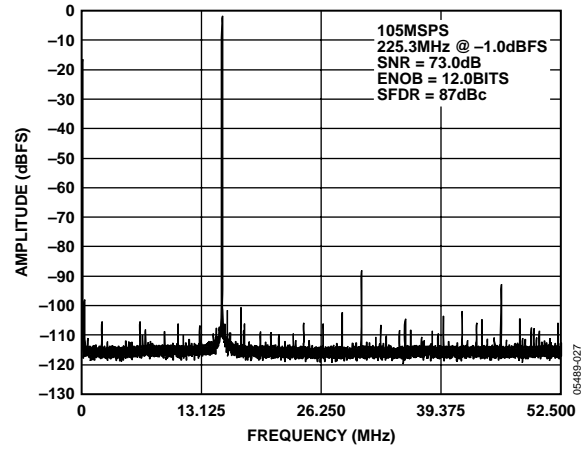

Figure 27. AD9445-105 64k Point Single-Tone FFT/105 MSPS/225.3 MHz

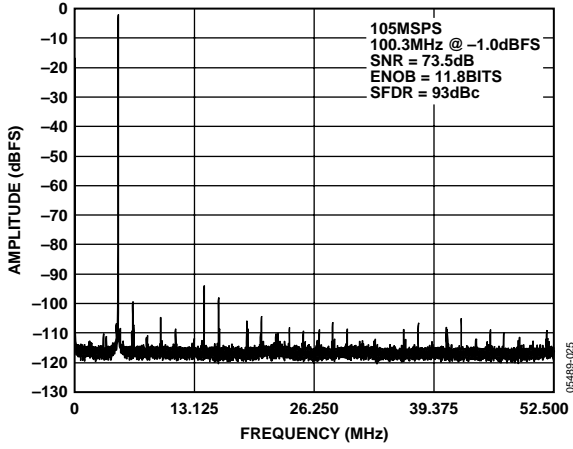

Figure 25. AD9445-105 64k Point Single-Tone FFT/105 MSPS/100.3 MHz

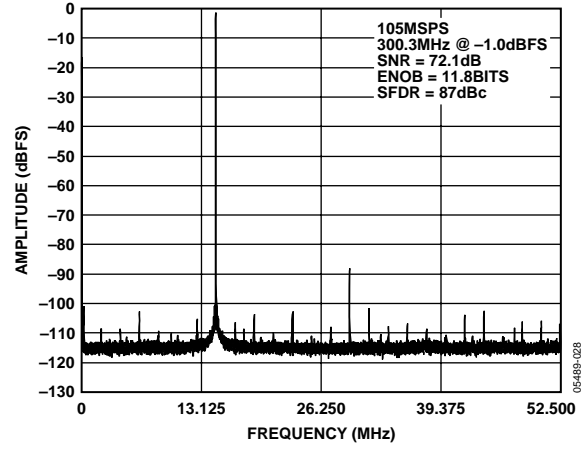

Figure 28. AD9445-105 64k Point Single-Tone FFT/105 MSPS/300.3 MHz

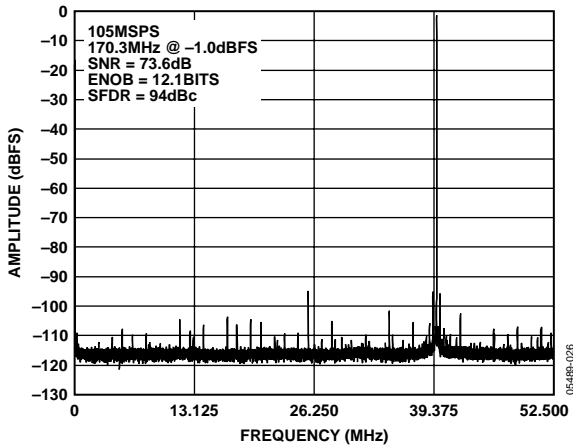

Figure 26. AD9445-105 64k Point Single-Tone FFT/105 MSPS/170.3 MHz

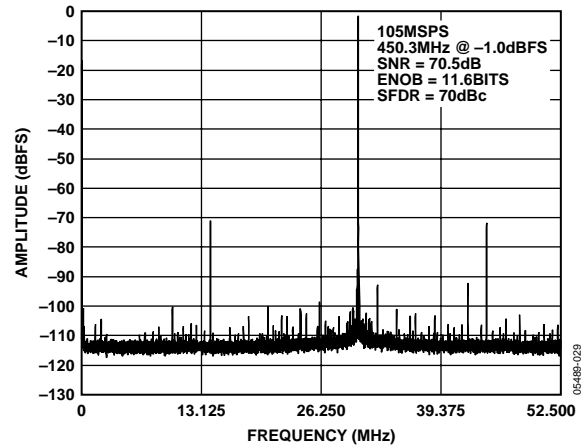

Figure 29. AD9445-105 64k Point Single-Tone FFT/105 MSPS/450.3 MHz

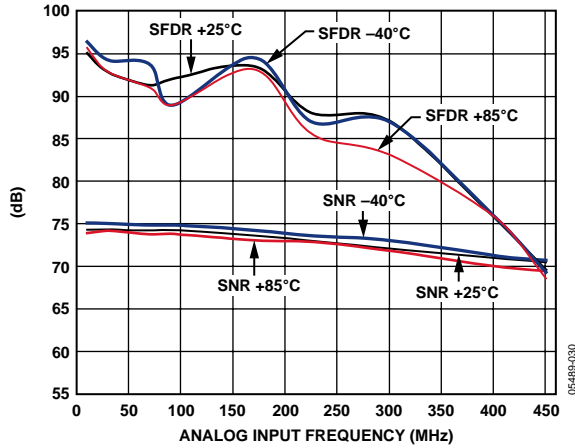

Figure 30. AD9445-105 SNR/SFDR vs. Analog Input Frequency, 105 MSPS, 2.0 V p-p

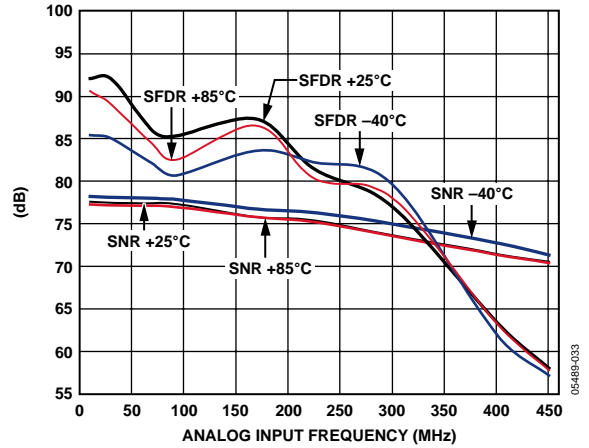

Figure 33. AD9445-105 SNR/SFDR vs. Analog Input Frequency, 105 MSPS, 3.2 V p-p

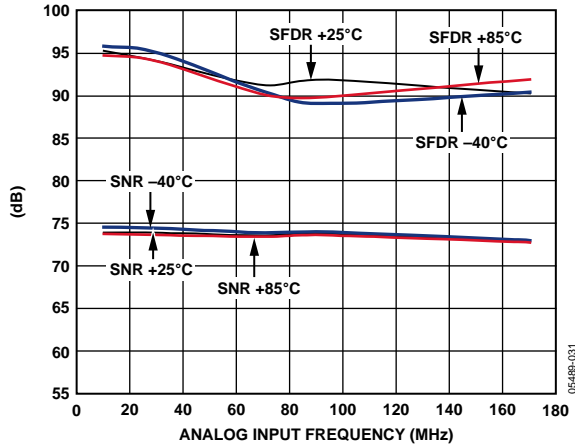

Figure 31. AD9445-105 SNR/SFDR vs. Analog Input Frequency, 3.2 V p-p Input Range, 105 MSPS, CMOS Output Mode

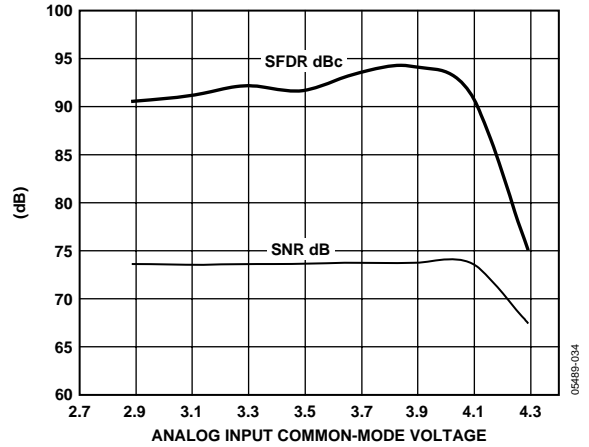

Figure 34. AD9445-105 SNR/SFDR vs. Analog Input Common Mode, 105 MSPS/10.3 MHz

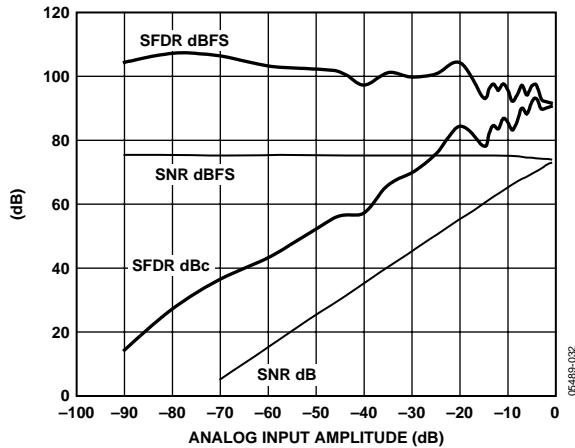

Figure 32. AD9445-105 SNR/SFDR vs. Analog Input Level, 105 MSPS/225.3 MHz

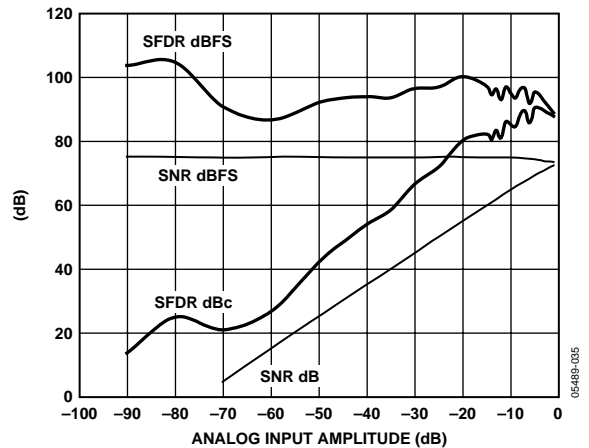

Figure 35. AD9445-105 SNR/SFDR vs. Analog Input Level, 105 MSPS/225.3 MHz, CMOS Output Mode

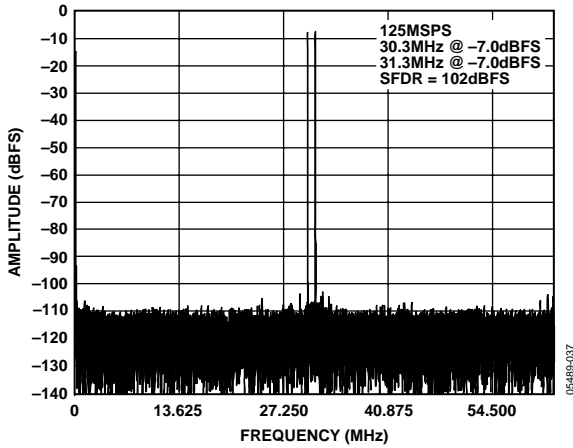

Figure 36. AD9445-125 64k Point Two-Tone FFT/  
125 MSPS/30.3 MHz, 31.3 MHz

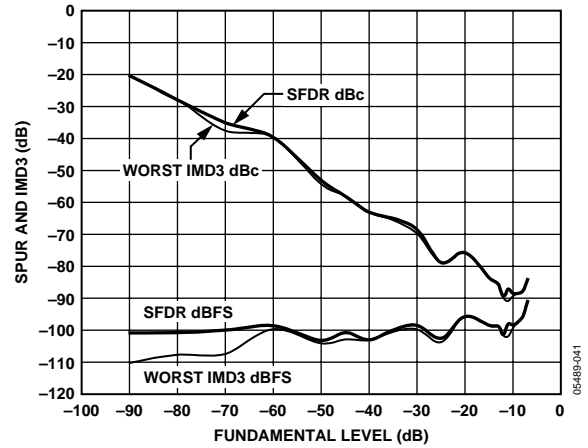

Figure 39. AD9445-125 Two-Tone SFDR vs. Analog Input Level  
125 MSPS/170.3 MHz, 171.3 MHz

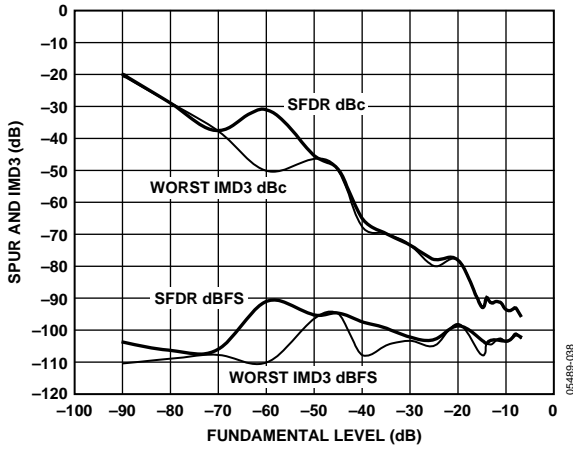

Figure 37. AD9445-125 Two-Tone SFDR vs. Analog Input Level  
125 MSPS/30.3 MHz, 31.3 MHz

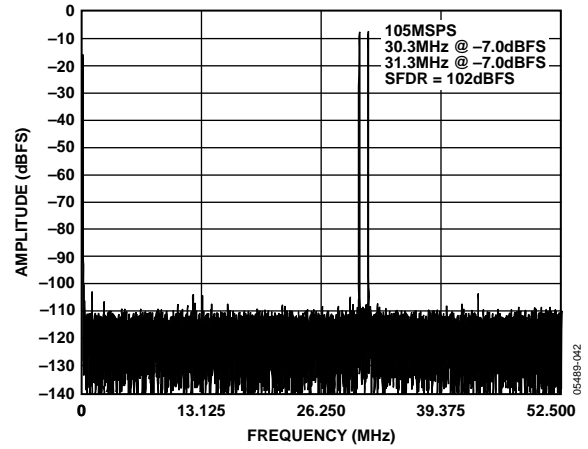

Figure 40. AD9445-105 64k Point Two-Tone FFT/105 MSPS/30.3 MHz, 31.3 MHz

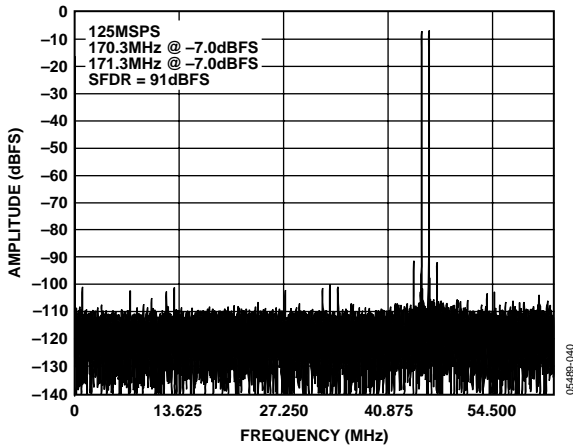

Figure 38. AD9445-125 64k Point Two-Tone FFT/  
125 MSPS/170.3 MHz, 171.3 MHz

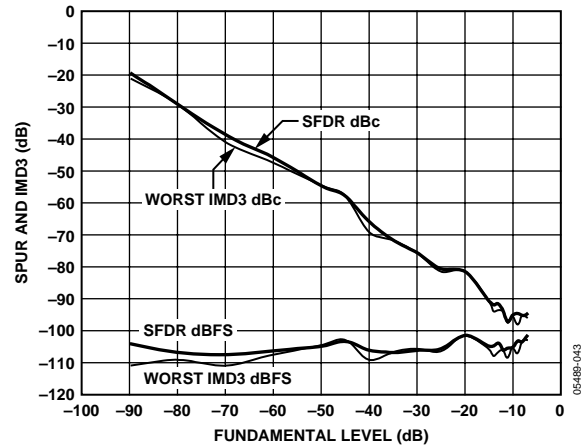

Figure 41. AD9445-105 Two-Tone SFDR vs. Analog Input Level  
105 MSPS/30.3 MHz, 31.3 MHz

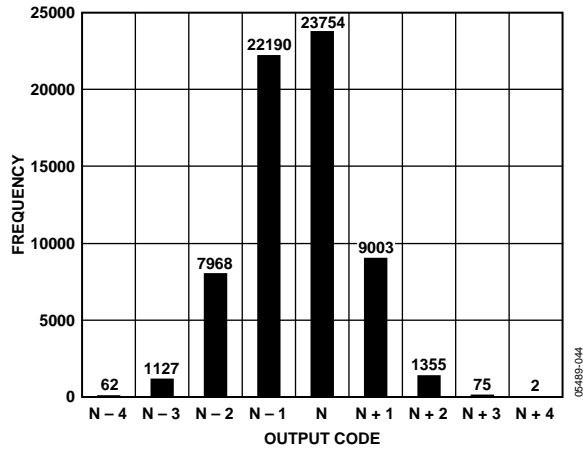

Figure 42. AD9445-125 Grounded Input Histogram

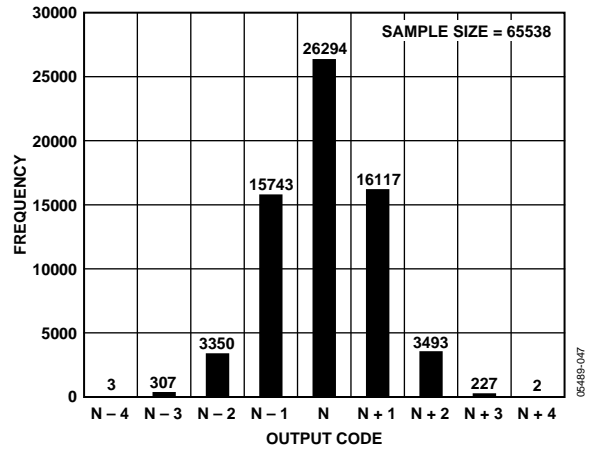

Figure 45. AD9445-105 Grounded Input Histogram

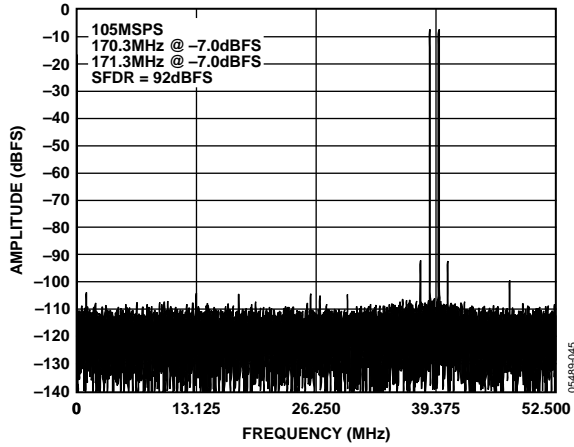

Figure 43. AD9445-105 64k Point Two-Tone FFT/105 MS/170.3 MHz, 171.3 MHz

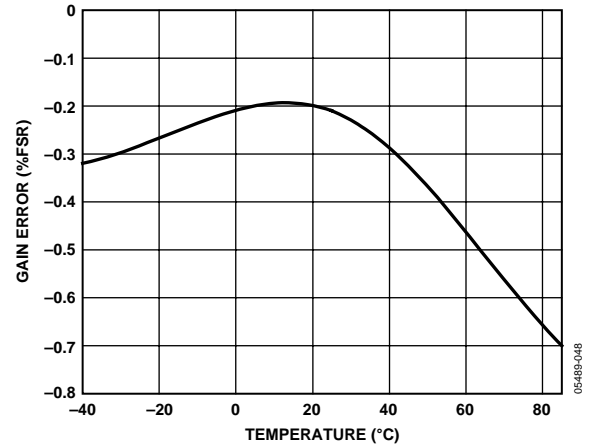

Figure 46. AD9445-125 Gain vs. Temperature

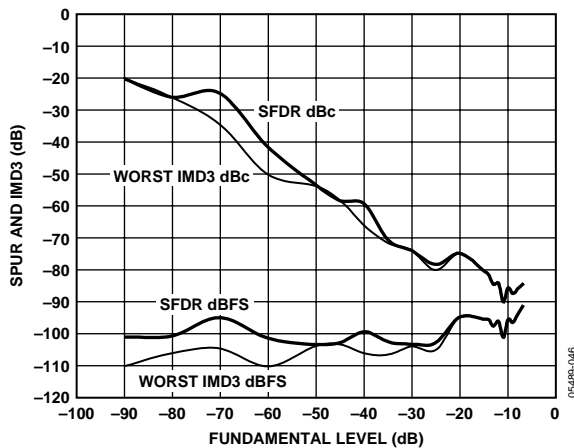

Figure 44. AD9445-105 Two-Tone SFDR vs. Analog Input Level  
105 MS/PS/170.3 MHz, 171.3 MHz

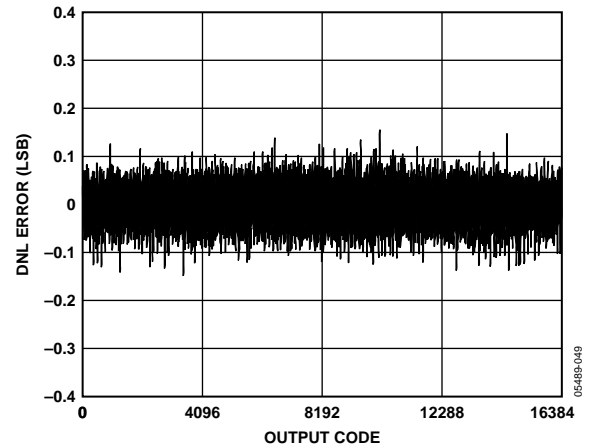

Figure 47. AD9445-105 DNL Error vs. Output Code, 105 MS/PS, 10.3 MHz

# AD9445

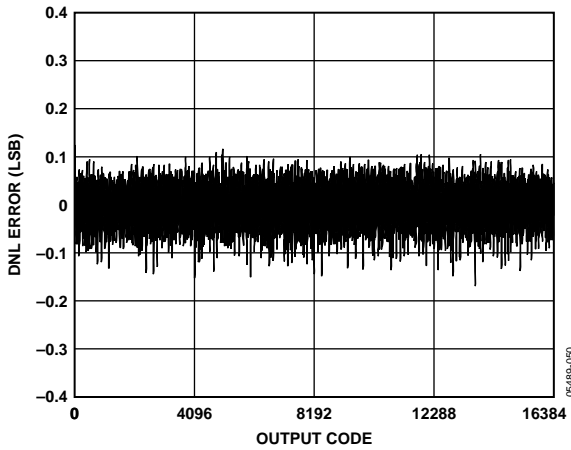

Figure 48. AD9445-125 DNL Error vs. Output Code, 125 MSPS, 10.3 MHz

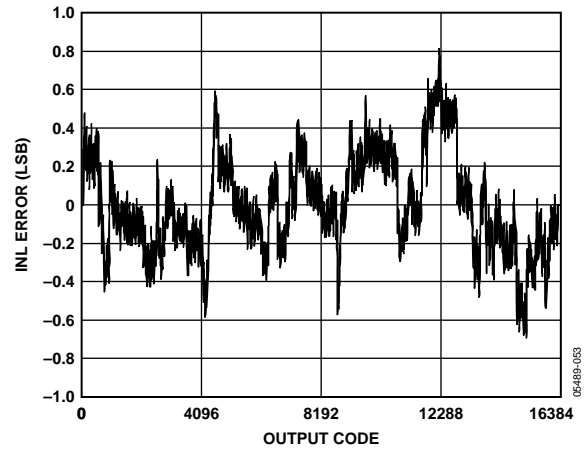

Figure 51. AD9445-125 INL Error vs. Output Code, 125 MSPS, 10.3 MHz

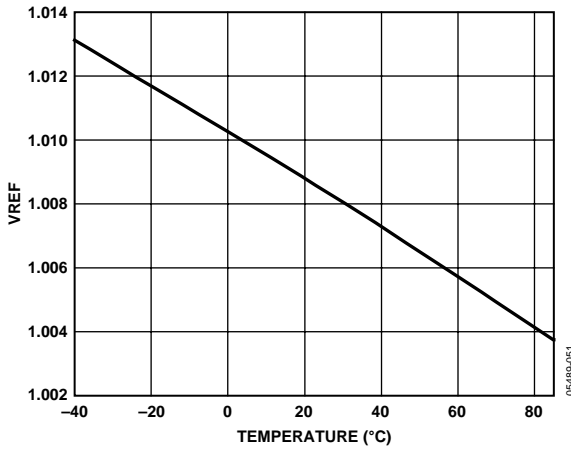

Figure 49. AD9445-125 VREF vs. Temperature

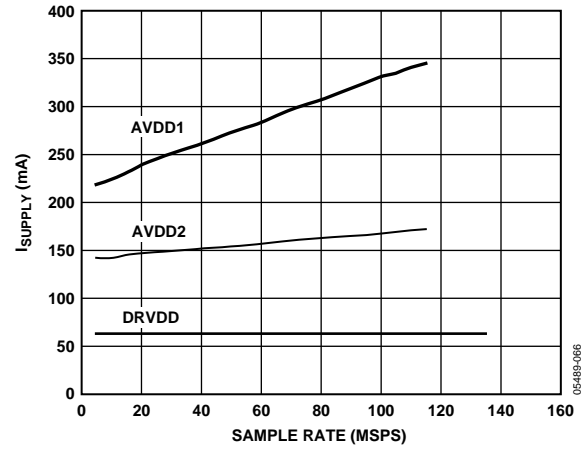

Figure 52. AD9445-105 Power Supply Current vs. Sample Rate 10.3 MHz @ -1 dBFS

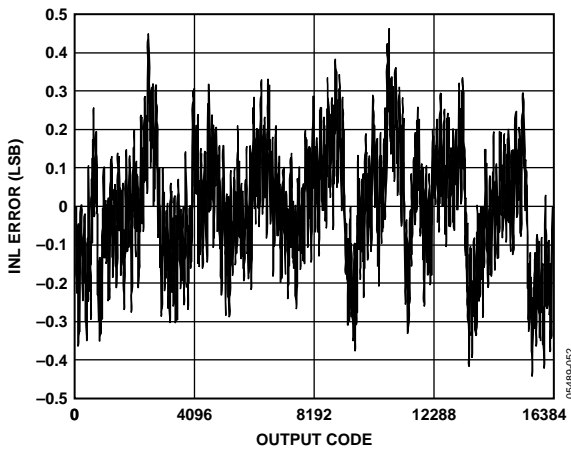

Figure 50. AD9445-105 INL Error vs. Output Code, 105 MSPS, 10.3 MHz

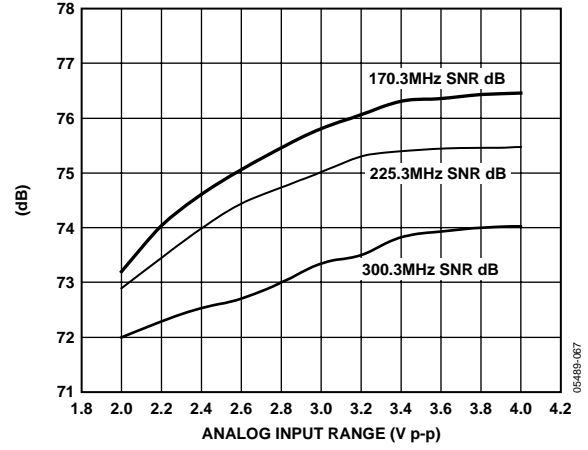

Figure 53. AD9445-125 SNR vs. Analog Input Range, 125 MSPS/170.3 MHz, 225.3 MHz, 300.3 MHz

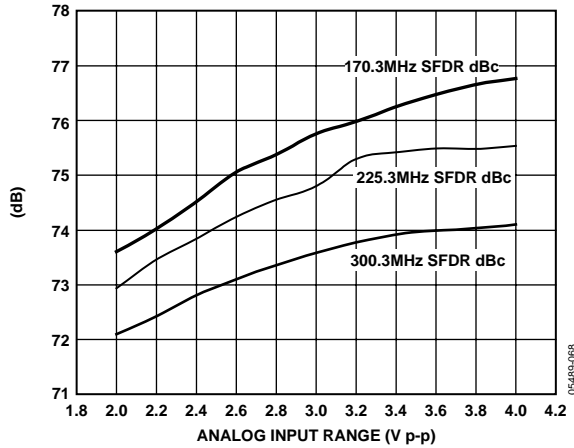

Figure 54. AD9445-105 SNR vs. Analog Input Range, 105 MSPS/170.3 MHz, 225.3 MHz, 300.3 MHz

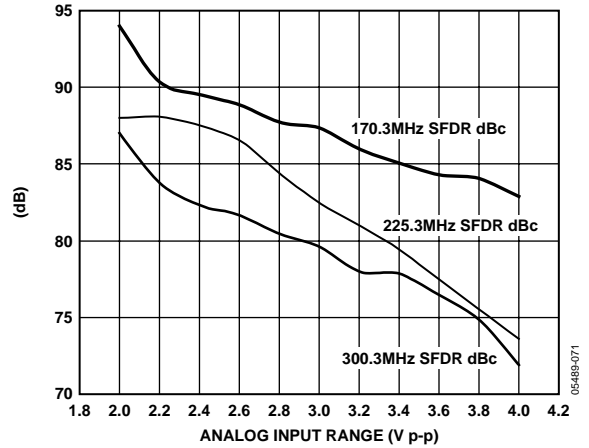

Figure 57. AD9445-105 SFDR vs. Analog Input Range, 105 MSPS/170.3 MHz, 225.3 MHz, 300.3 MHz

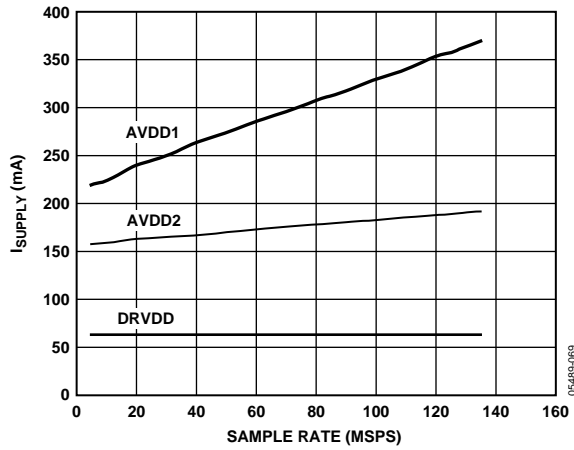

Figure 55. AD9445-125 Power Supply Current vs. Sample Rate 10.3 MHz @ -1 dBFS

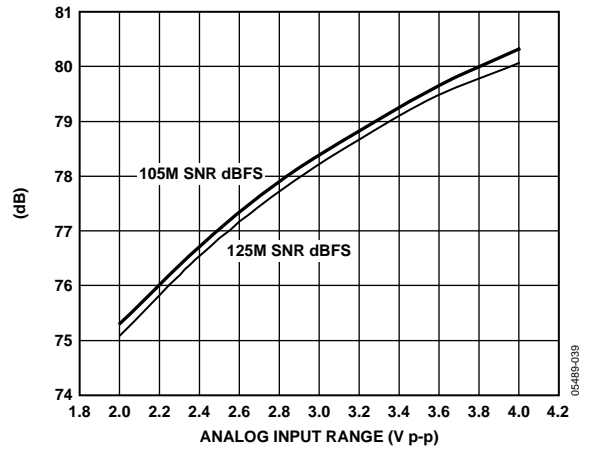

Figure 58. SNR vs. Analog Input Range, 2.3 MHz @ -30 dBFS

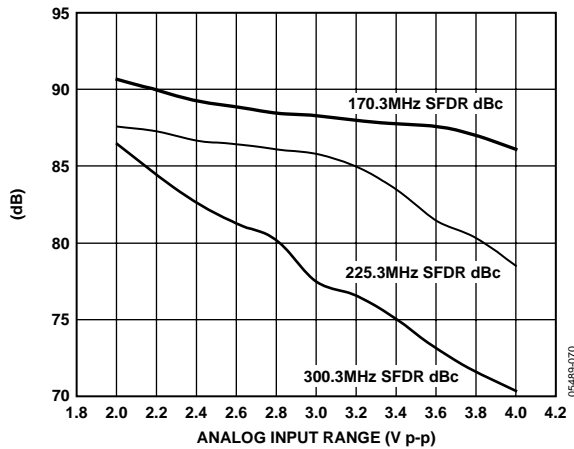

Figure 56. AD9445-125 SFDR vs. Analog Input Range, 125 MSPS/170.3 MHz, 225.3 MHz, 300.3 MHz

## THEORY OF OPERATION

The AD9445 architecture is optimized for high speed and ease of use. The analog inputs drive an integrated, high bandwidth track-and-hold circuit that samples the signal prior to quantization by the 14-bit pipeline ADC core. The device includes an on-board reference and input logic that accepts TTL, CMOS, or LVPECL levels. The digital output logic levels are user selectable as standard 3 V CMOS or LVDS (ANSI-644 compatible) via the OUTPUT MODE pin.

### ANALOG INPUT AND REFERENCE OVERVIEW

A stable and accurate 0.5 V band gap voltage reference is built into the AD9445. The input range can be adjusted by varying the reference voltage applied to the AD9445, using either the internal reference or an externally applied reference voltage. The input span of the ADC tracks reference voltage changes linearly.

#### Internal Reference Connection

A comparator within the AD9445 detects the potential at the SENSE pin and configures the reference into three possible states, which are summarized in Table 9. If SENSE is grounded, the reference amplifier switch is connected to the internal resistor divider (see Figure 59), setting VREF to ~1.0 V. Connecting the SENSE pin to VREF switches the reference amplifier output to the SENSE pin, completing the loop and providing a ~1.0 V reference output. If a resistor divider is connected as shown in Figure 60, the switch again sets to the SENSE pin. This puts the reference amplifier in a noninverting mode with the VREF output defined as

$$VREF = 0.5 V \times \left(1 + \frac{R2}{R1}\right)$$

In all reference configurations, REFT and REFB drive the analog-to-digital conversion core and establish its input span. The input range of the ADC always equals twice the voltage at the reference pin for either an internal or an external reference.

#### Internal Reference Trim

The internal reference voltage is trimmed during the production test to adjust the gain (analog input voltage range) of the AD9445. Therefore, there is little advantage to the user supplying an external voltage reference to the AD9445. The gain trim is performed with the AD9445 input range set to 2.0 V p-p nominal (SENSE

connected to AGND). Because of this trim and the maximum ac performance provided by the 2.0 V p-p analog input range, there is little benefit to using analog input ranges <2 V p-p. Users are cautioned that the differential nonlinearity of the ADC varies with the reference voltage. Configurations that use <2.0 V p-p may exhibit missing codes and, therefore, degraded noise and distortion performance.

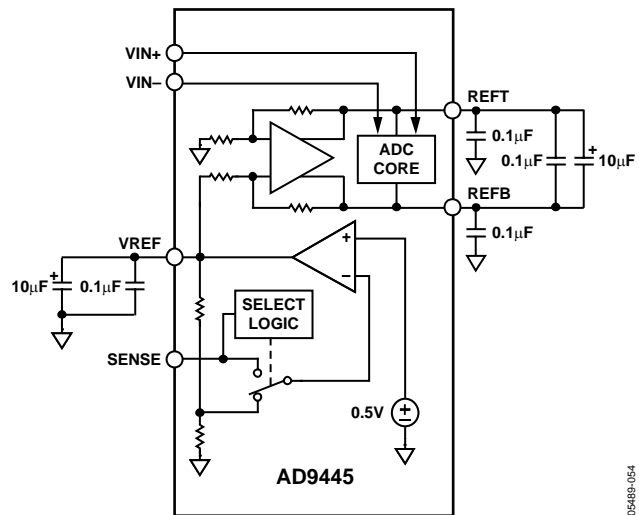

Figure 59. Internal Reference Configuration

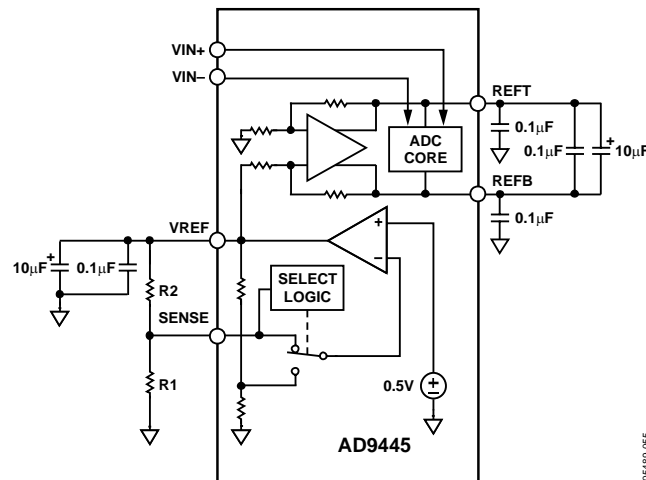

Figure 60. Programmable Reference Configuration

Table 9. Reference Configuration Summary

Selected Mode	SENSE Voltage	Resulting VREF (V)	Resulting Differential Span (V p-p)
External Reference	AVDD1	N/A	2 × external reference
Programmable Reference	0.2 V to VREF	$0.5 \times \left(1 + \frac{R2}{R1}\right)$ (See Figure 60)	2 × VREF
Internal Fixed Reference	AGND to 0.2 V	1.0	2.0



### External Reference Operation

The AD9445's internal reference is trimmed to enhance the gain accuracy of the ADC. An external reference may be more stable over temperature, but the gain of the ADC is not likely to improve. Figure 49 shows the typical drift characteristics of the internal reference in both 1 V and 0.5 V modes.

When the SENSE pin is tied to AVDD, the internal reference is disabled, allowing the use of an external reference. An internal reference buffer loads the external reference with an equivalent 7 k $\Omega$  load. The internal buffer still generates the positive and negative full-scale references, REFT and REFB, for the ADC core. The input span is always twice the value of the reference voltage; therefore, the external reference must be limited to a maximum of 1.6 V.

### Analog Inputs

As with most new high speed, high dynamic range ADCs, the analog input to the AD9445 is differential. Differential inputs improve on-chip performance because signals are processed through attenuation and gain stages. Most of the improvement is a result of differential analog stages having high rejection of even-order harmonics. There are also benefits at the PCB level. First, differential inputs have high common-mode rejection of stray signals, such as ground and power noise. Second, they provide good rejection of common-mode signals, such as local oscillator feedthrough. The specified noise and distortion of the AD9445 cannot be realized with a single-ended analog input, so such configurations are discouraged. Contact sales for recommendations of other 14-bit ADCs that support single-ended analog input configurations.

With the 1 V reference, which is the nominal value (see the Internal Reference Trim section), the differential input range of the AD9445 analog input is nominally 2.0 V p-p or 1.0 V p-p on each input (VIN+ or VIN-).

The AD9445 analog input voltage range is offset from ground by 3.5 V. Each analog input connects through a 1 k $\Omega$  resistor to the 3.5 V bias voltage and to the input of a differential buffer. The internal bias network on the input properly biases the buffer for maximum linearity and range (see the Equivalent Circuits section).

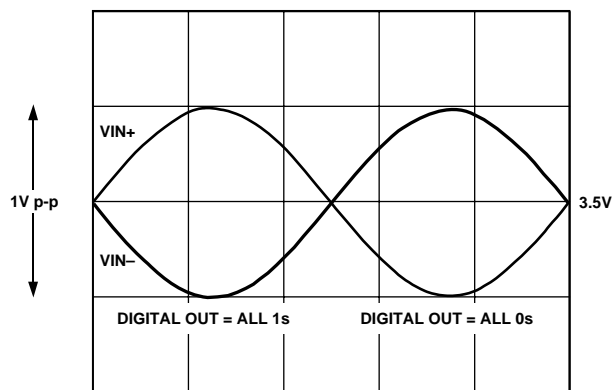

Figure 61. Differential Analog Input Range for  $V_{REF} = 1.0\text{ V}$

Therefore, the analog source driving the AD9445 should be ac-coupled to the input pins. The recommended method for driving the analog input of the AD9445 is to use an RF transformer to convert single-ended signals to differential (see Figure 62). Series resistors between the output of the transformer and the AD9445 analog inputs help isolate the analog input source from switching transients caused by the internal sample-and-hold circuit. The series resistors, along with the 1 k $\Omega$  resistors connected to the internal 3.5 V bias, must be considered in impedance matching the transformer input. For example, if  $R_T$  is set to 51  $\Omega$ ,  $R_S$  is set to 33  $\Omega$ , and there is a 1:1 impedance ratio transformer, the input will match a 50  $\Omega$  source with a full-scale drive of 10.0 dBm. The 50  $\Omega$  impedance matching can also be incorporated on the secondary side of the transformer, as shown in the evaluation board schematic (see Figure 67).

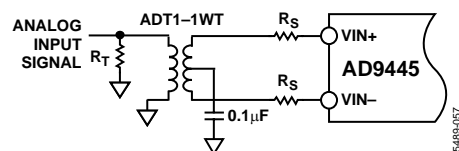

Figure 62. Transformer-Coupled Analog Input Circuit

### High IF Applications

In applications where the analog input frequency range is >100 MHz, the phase and amplitude matching at the analog inputs becomes critical to optimize performance of the ADC. The circuit in Figure 63 can be used to optimize the matching of these parameters. This configuration uses a double balun configuration that has low parasitics, high bandwidth, and parasitic cancellation.

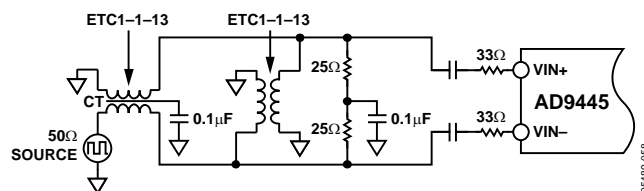

Figure 63. Double Balun-Coupled Analog Input Circuit

## CLOCK INPUT CONSIDERATIONS

Any high speed ADC is extremely sensitive to the quality of the sampling clock provided by the user. A track-and-hold circuit is essentially a mixer, and any noise, distortion, or timing jitter on the clock is combined with the desired signal at the analog-to-digital output. For that reason, considerable care was taken in the design of the clock inputs of the AD9445, and the user is advised to give careful thought to the clock source.

Typical high speed ADCs use both clock edges to generate a variety of internal timing signals and, as a result, may be sensitive to the clock duty cycle. Commonly a 5% tolerance is required on the clock duty cycle to maintain dynamic performance characteristics. The AD9445 contains a clock duty cycle stabilizer (DCS) that retimes the nonsampling edge, providing an internal clock signal with a nominal 50% duty cycle. Noise and distortion performance are nearly flat for a 30% to 70% duty cycle with the DCS enabled. The DCS circuit locks to the rising edge of CLK+ and optimizes timing internally. This allows for a wide range of input duty cycles at the input without degrading performance. Jitter in the rising edge of the input is still of paramount concern and is not reduced by the internal stabilization circuit. The duty cycle control loop does not function for clock rates of less than 30 MHz nominally. The loop is associated with a time constant that should be considered in applications where the clock rate can change dynamically, requiring a wait time of 1.5  $\mu$ s to 5  $\mu$ s after a dynamic clock frequency increase or decrease before the DCS loop is relocked to the input signal. During the time that the loop is not locked, the DCS loop is bypassed, and the internal device timing is dependent on the duty cycle of the input clock signal. In such an application, it may be appropriate to disable the duty cycle stabilizer. In all other applications, enabling the DCS circuit is recommended to maximize ac performance.

The DCS circuit is controlled by the DCS MODE pin; a CMOS logic low (AGND) on DCS MODE enables the duty cycle stabilizer, and logic high (AVDD1 = 3.3 V) disables the controller.

The AD9445 input sample clock signal must be a high quality, extremely low phase noise source to prevent degradation of performance. Maintaining 14-bit accuracy places a premium on the encode clock phase noise. SNR performance can easily degrade by 3 dB to 4 dB with 70 MHz analog input signals when using a high jitter clock source. (See the [AN-501 Application Note, Aperture Uncertainty and ADC System Performance](#).) For optimum performance, the AD9445 must be clocked differentially. The sample clock inputs are internally biased to  $\sim 2.2$  V, and the input signal is usually ac-coupled into the CLK+ and CLK- pins via a transformer or capacitors. Figure 64 shows one preferred method for clocking the AD9445. The clock source (low jitter) is converted from single-ended to differential using an RF transformer. The back-to-back

Schottky diodes across the secondary of the transformer limit clock excursions into the AD9445 to approximately 0.8 V p-p differential. This helps prevent the large voltage swings of the clock from feeding through to other portions of the AD9445 and limits the noise presented to the sample clock inputs.

If a low jitter clock is available, it may help to band-pass filter the clock reference before driving the ADC clock inputs. Another option is to ac couple a differential ECL/PECL signal to the encode input pins, as shown in Figure 65.

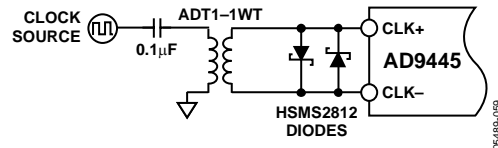

Figure 64. Crystal Clock Oscillator, Differential Encode

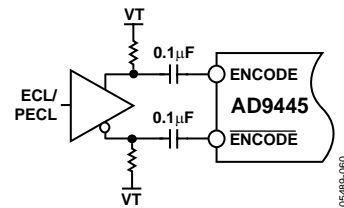

Figure 65. Differential ECL for Encode

## Jitter Considerations

High speed, high resolution ADCs are sensitive to the quality of the clock input. The degradation in SNR at a given input frequency ( $f_{INPUT}$ ) and rms amplitude due only to aperture jitter ( $t_j$ ) can be calculated using the following equation:

$$SNR = 20 \log[2\pi f_{INPUT} \times t_j]$$

In the equation, the rms aperture jitter represents the root-mean-square of all jitter sources, which includes the clock input, analog input signal, and ADC aperture jitter specification. IF undersampling applications are particularly sensitive to jitter, see Figure 66.

The clock input should be treated as an analog signal in cases where aperture jitter may affect the dynamic range of the AD9445. Power supplies for clock drivers should be separated from the ADC output driver supplies to avoid modulating the clock signal with digital noise. Low jitter crystal-controlled oscillators make the best clock sources. If the clock is generated from another type of source (by gating, dividing, or another method), it should be synchronized by the original clock during the last step.

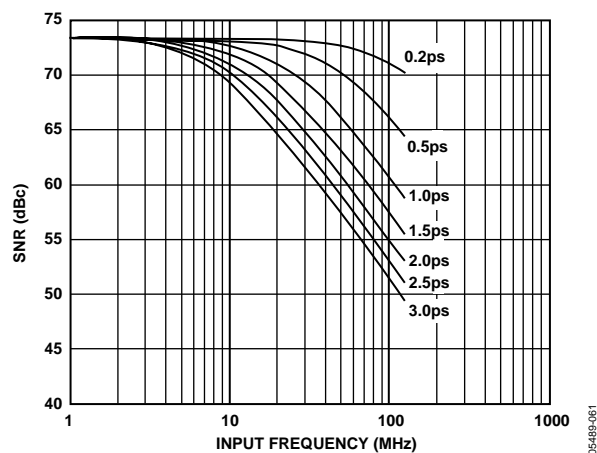

Figure 66. SNR vs. Input Frequency and Jitter

## POWER CONSIDERATIONS

Care should be taken when selecting a power source. The use of linear dc supplies is highly recommended. Switching supplies tend to have radiated components that may be received by the AD9445. Each of the power supply pins should be decoupled as closely to the package as possible using 0.1  $\mu\text{F}$  chip capacitors.

The AD9445 has separate digital and analog power supply pins. The analog supplies are denoted AVDD1 (3.3 V) and AVDD2 (5 V), and the digital supply pins are denoted DRVDD. Although the AVDD1 and DRVDD supplies can be tied together, best performance is achieved when the supplies are separate. This is because the fast digital output swings can couple switching current back into the analog supplies. Note that both AVDD1 and AVDD2 must be held within 5% of the specified voltage.

The DRVDD supply of the AD9445 is a dedicated supply for the digital outputs in either LVDS or CMOS output mode. When in LVDS mode, the DRVDD should be set to 3.3 V. In CMOS mode, the DRVDD supply can be connected from 2.5 V to 3.6 V for compatibility with the receiving logic.

## DIGITAL OUTPUTS

### LVDS Mode

The off-chip drivers on the chip can be configured to provide LVDS-compatible output levels via Pin 3 (OUTPUT MODE). LVDS outputs are available when OUTPUT MODE is CMOS logic high (or AVDD1 for convenience) and a 3.74 k $\Omega$  R<sub>SET</sub>

resistor is placed at Pin 5 (LVDS\_BIAS) to ground. Dynamic performance, including both SFDR and SNR, is maximized when the AD9445 is used in LVDS mode; designers are encouraged to take advantage of this mode. The AD9445 outputs include complimentary LVDS outputs for each data bit (Dx+/Dx-), the overrange output (OR+/OR-), and the output data clock output (DCO+/DCO-). The R<sub>SET</sub> resistor current is multiplied on-chip, setting the output current at each output equal to a nominal 3.5 mA ( $11 \times I_{R_{SET}}$ ). A 100  $\Omega$  differential termination resistor placed at the LVDS receiver inputs results in a nominal 350 mV swing at the receiver. LVDS mode facilitates interfacing with LVDS receivers in custom ASICs and FPGAs that have LVDS capability for superior switching performance in noisy environments. Single point-to-point net topologies are recommended, with a 100  $\Omega$  termination resistor placed as close to the receiver as possible. It is recommended to keep the trace length less than 2 inches and to keep differential output trace lengths as equal as possible.

### CMOS Mode

In applications that can tolerate a slight degradation in dynamic performance, the AD9445 output drivers can be configured to interface with 2.5 V or 3.3 V logic families by matching DRVDD to the digital supply of the interfaced logic. CMOS outputs are available when OUTPUT MODE is CMOS logic low (or AGND for convenience). In this mode, the output data bits, Dx, are single-ended CMOS, as is the overrange output, OR. The output clock is provided as a differential CMOS signal, DCO+/DCO-. Lower supply voltages are recommended to avoid coupling switching transients back to the sensitive analog sections of the ADC. The capacitive load to the CMOS outputs should be minimized, and each output should be connected to a single gate through a series resistor (220  $\Omega$ ) to minimize switching transients caused by the capacitive loading.

## TIMING

The AD9445 provides latched data outputs with a pipeline delay of 13 clock cycles. Data outputs are available one propagation delay ( $t_{PD}$ ) after the rising edge of CLK+. Refer to Figure 2 and Figure 3 for detailed timing diagrams.

# AD9445

## OPERATIONAL MODE SELECTION

### Data Format Select

The data format select (DFS) pin of the AD9445 determines the coding format of the output data. This pin is 3.3 V CMOS-compatible, with logic high (or AVDD1, 3.3 V) selecting twos complement and DFS logic low (AGND) selecting offset binary format. Table 10 summarizes the output coding.

### Output Mode Select

The OUTPUT MODE pin controls the logic compatibility, as well as the pinout of the digital outputs. This pin is a CMOS-compatible input. With OUTPUT MODE = 0 (AGND), the AD9445 outputs are CMOS compatible, and the pin assignment for the device is as defined in Table 8. With OUTPUT MODE = 1 (AVDD1, 3.3 V), the AD9445 outputs are LVDS compatible, and the pin assignment for the device is as defined in Table 7.

### Duty Cycle Stabilizer

The DCS circuit is controlled by the DCS MODE pin; a CMOS logic low (AGND) on DCS MODE enables the DCS, and logic high (AVDD1, 3.3 V) disables the controller.

## RF ENABLE

The RF ENABLE pin is a CMOS-compatible control pin that optimizes the configuration of the AD9445 analog front end. The crossover analog input frequency for determining the RF ENABLE connection differs for the 105 MSPS and 125 MSPS speed grades. For the 125 MSPS speed grade, connecting the RF ENABLE to AGND optimizes SFDR performance for applications with analog input frequencies <210 MHz. For applications with analog inputs >210 MHz, this pin should be connected to AVDD1 for optimum SFDR performance. Connecting this pin to AVDD1 reconfigures the ADC, thereby improving high IF and RF spurious performance. Operating in this mode increases power dissipation from AVDD2 by 150 mW to 200 mW. For the 105 MSPS speed grade, connecting RF ENABLE to AGND optimizes SFDR performance for applications with analog input frequencies <230 MHz. For applications with analog inputs >230 MHz, this pin should be connected to AVDD1 to optimize performance.

Table 10. Digital Output Coding

Code	VIN+ – VIN– Input Span = 3.2 V p-p (V)	VIN+ – VIN– Input Span = 2 V p-p (V)	Digital Output Offset Binary (D13.....D0)	Digital Output Twos Complement (D13.....D0)
16,383	+1.600	+1.000	11 1111 1111 1111	01 1111 1111 1111
8192	0	0	10 0000 0000 0000	00 0000 0000 0000
8191	–0.000195	–0.000122	01 1111 1111 1111	11 1111 1111 1111
0	–1.60	–1.00	00 0000 0000 0000	10 0000 0000 0000

## EVALUATION BOARD

Evaluation boards are offered to configure the AD9445 in either CMOS or LVDS mode only. This design represents a recommended configuration for using the device over a wide range of sampling rates and analog input frequencies. These evaluation boards provide all the support circuitry required to operate the ADC in its various modes and configurations. Complete schematics are shown in Figure 67 through Figure 70. Gerber files are available from engineering applications demonstrating the proper routing and grounding techniques that should be applied at the system level.

It is critical that signal sources with very low phase noise (<60 fsec rms jitter) be used to realize the ultimate performance of the converter. Proper filtering of the input signal to remove harmonics and lower the integrated noise at the input is also necessary to achieve the specified noise performance.

The evaluation boards are shipped with a 115 V ac to 6 V dc power supply. The evaluation boards include low dropout regulators to generate the various dc supplies required by the AD9445 and its support circuitry. Separate power supplies are provided to isolate the DUT from the support circuitry. Each input configuration can be selected by proper connection of various jumpers (see Figure 67).

The LVDS mode evaluation boards include an LVDS-to-CMOS translator, making them compatible with the high speed ADC FIFO evaluation kit (HSC-ADC-EVALA-SC). The kit includes a high speed data capture board that provides a hardware solution for capturing up to 32 kB samples of high speed ADC output data in a FIFO memory chip (user upgradeable to 256 kB samples). Software is provided to enable the user to download the captured data to a PC via the USB port. This software also includes a behavioral model of the AD9445 and many other high speed ADCs.

Behavioral modeling of the AD9445 is also available at [www.analog.com/ADIsimADC](http://www.analog.com/ADIsimADC). The ADIsimADC™ software supports virtual ADC evaluation using ADI proprietary behavioral modeling technology. This allows rapid comparison between the AD9445 and other high speed ADCs with or without hardware evaluation boards.

The user can choose to remove the translator and terminations to access the LVDS outputs directly.

# AD9445

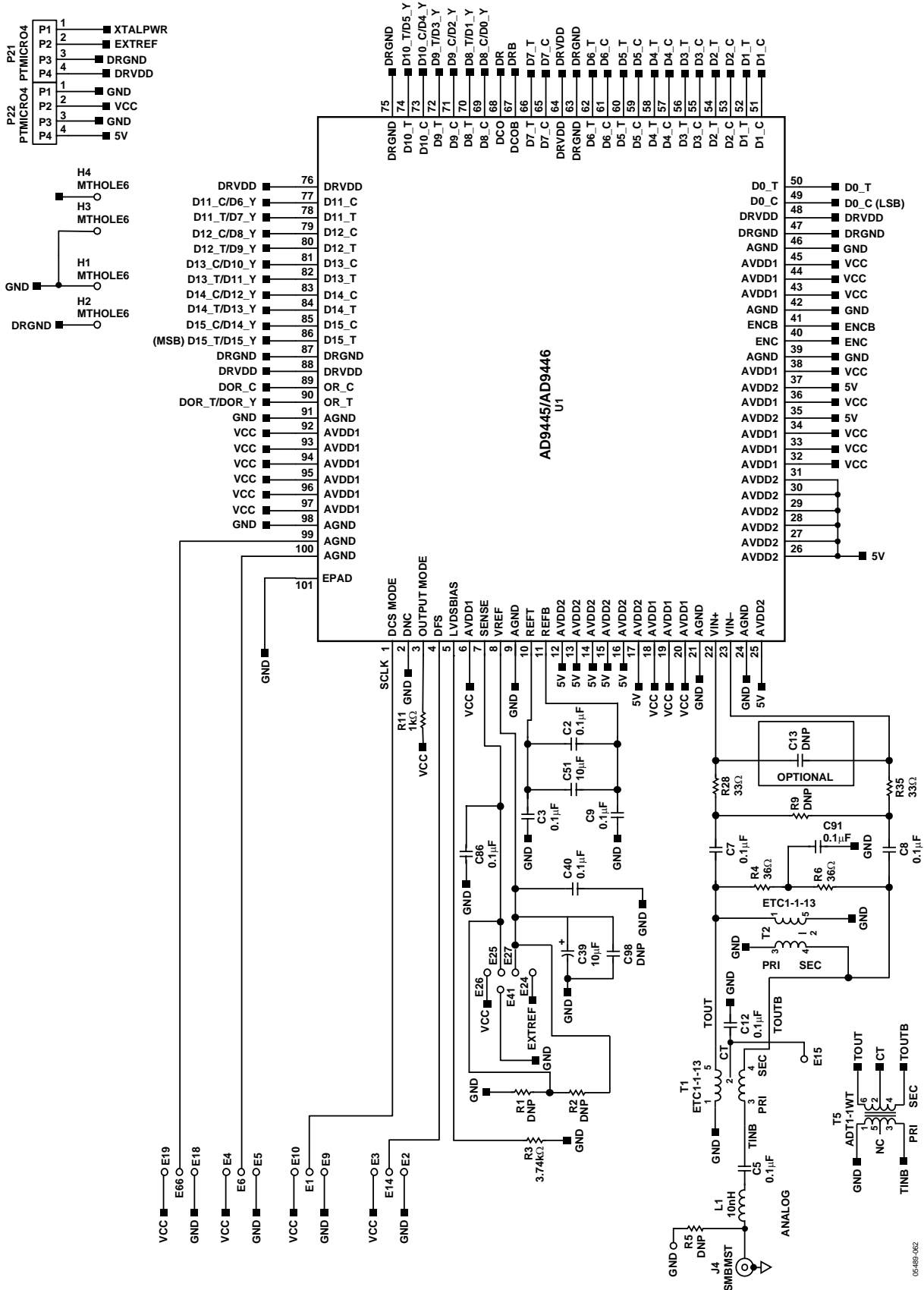

Figure 67. AD9445 Evaluation Board Schematic

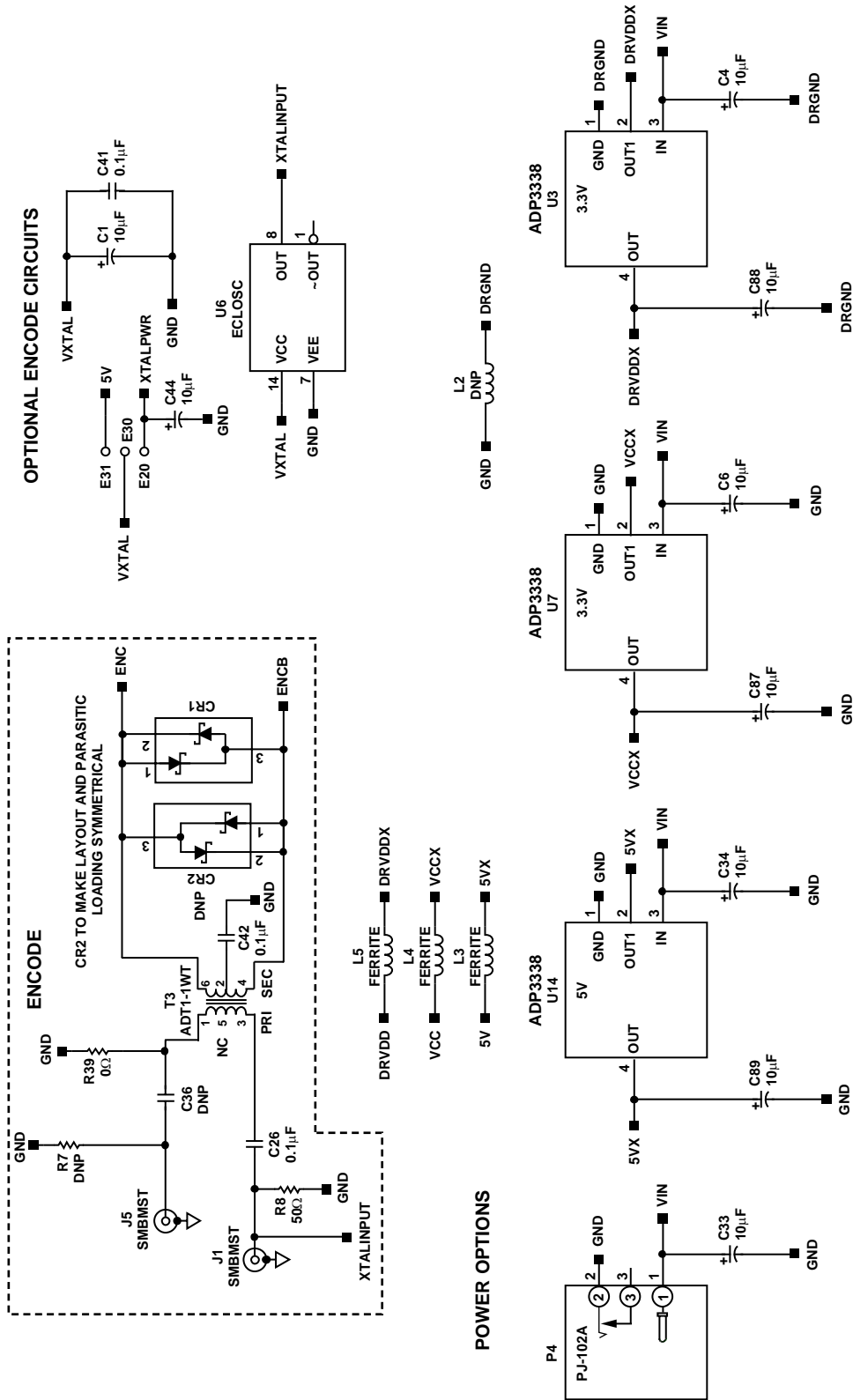

Figure 68. AD9445 Evaluation Board Schematic (Continued)

05489-063

## BYPASS CAPACITORS

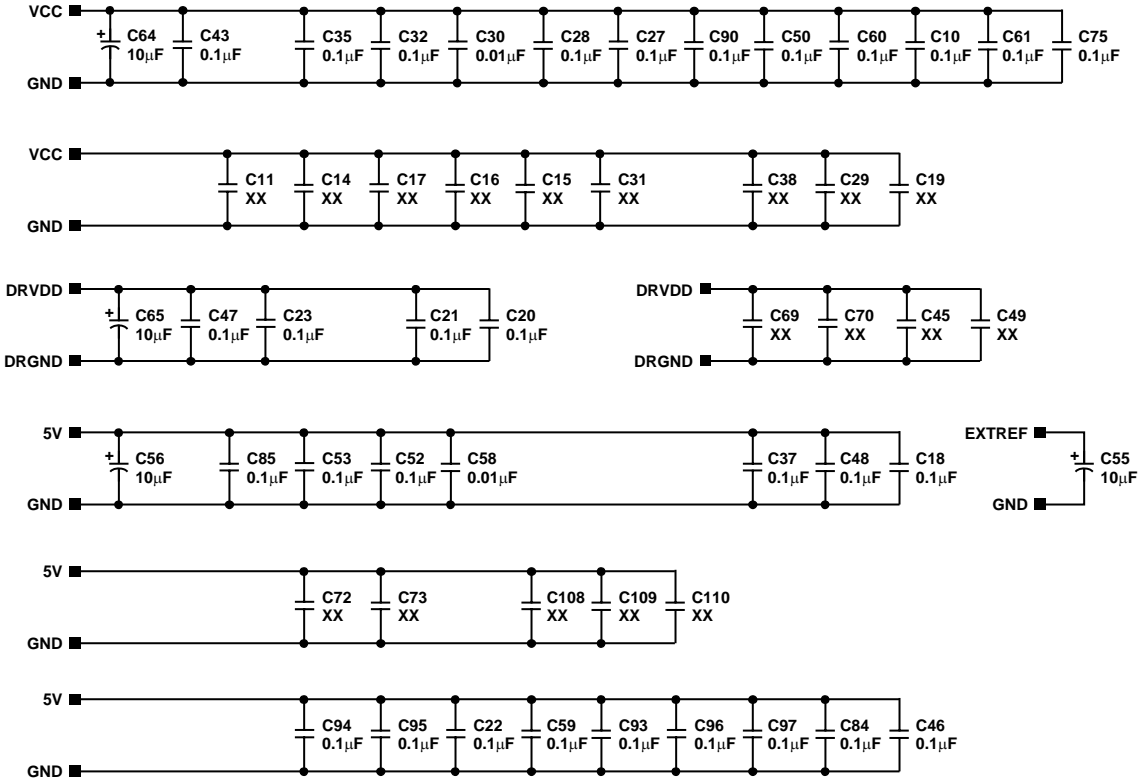

Figure 69. AD9445 Evaluation Board Schematic (Continued)

05489-064



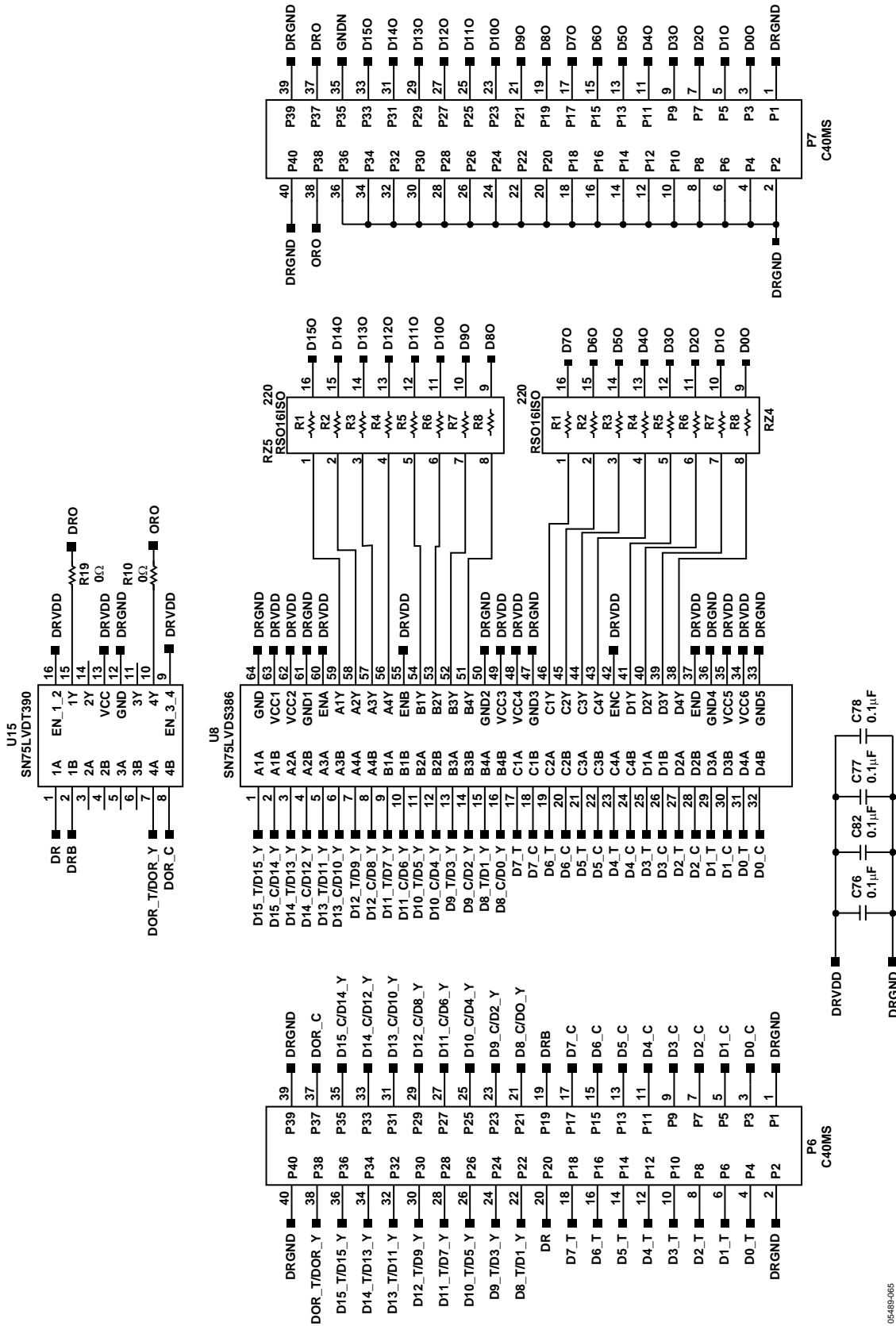

Figure 70. AD9445 Evaluation Board Schematic (Continued)

# AD9445

Table 11. AD9445-125 Baseband Customer Evaluation Board Bill of Materials

Item	Qty.	Reference Designator	Description	Package	Value	Manufacturer	Mfg. Part No.
1	7	C4, C6, C33, C34, C87, C88, C89	Capacitor	TAJD	10 $\mu$ F	Digi-Key Corporation	478-1699-2
2	44	C2, C3, C5, C7, C8, C9, C10, C11, C12, C15, C20, C21, C22, C23, C26, C27, C28, C32, C35, C38, C40, C42, C43, C46, C47, C48, C50, C52, C53, C59, C60, C76, C77, C78, C82, C84, C85, C86, C90, C91, C94, C95, C96, C97	Capacitor	402	0.1 $\mu$ F	Digi-Key Corporation	PCC2146CT-ND
3	2	C30, C58	Capacitor	201	0.01 $\mu$ F	Digi-Key Corporation	445-1796-1-ND
4	4	C39, C56, C64, C65	Capacitor	TAJD	10 $\mu$ F	Digi-Key Corporation	478-1699-2
5	1	C51	Capacitor	805	10 $\mu$ F	Digi-Key Corporation	490-1717-1-ND
6	1	CR1	Diode	SOT23M5		Digi-Key Corporation	MA3X71600LCT-ND
7	1	CR2	Diode	SOT23M5		Digi-Key Corporation	MA3X71600LCT-ND
8	20	E1, E2, E3, E4, E5, E6, E9, E10, E14, E18, E19, E20, E24, E25, E26, E27, E30, E31, E36, E41	Header	EHOLE		Mouser Electronics	517-6111TG
9	2	J1, J4	SMA	SMA		Digi-Key Corporation	ARFX1231-ND
10	1	L1	Inductor	0603A	10 nH	Coilcraft, Inc.	0603CS-10NXGBU
11	3	L3, L4, L5	EMIFIL <sup>®</sup> BLM31PG500SN1L	1206MIL		Mouser Electronics	81-BLM31P500S
12	1	P4	PJ-002A	PJ-002A		Digi-Key Corporation	CP-002A-ND
13	1	P7	Header	C40MS		Samtec, Inc.	TSW-120-08-L-D-RA
14	1	R3	Resistor	402	3.74 k $\Omega$	Digi-Key Corporation	P3.74KLCT-ND
15	1	R8	Resistor	402	50 $\Omega$	Digi-Key Corporation	P49.9LCT-ND
16	4	R10, R19, R39, L2	Resistor	402	0 $\Omega$	Digi-Key Corporation	P0.0JCT-ND
17	1	R11	BRES402	402	1 k $\Omega$	Digi-Key Corporation	P1.0KLCT-ND
18	2	R28, R35	Resistor	402	33 $\Omega$	Digi-Key Corporation	P33JCT-ND
19	2	RZ4, RZ5	Resistor array	16PIN	22 $\Omega$	Digi-Key Corporation	742C163220JCT-ND
20	2	T3, T5	Transformer	ADT1-1WT		Mini-Circuits	ADT1-1WT
21	1	U1	AD9445BSVZ-125	SV-100-3		Analog Devices, Inc.	AD9445BSVZ-125
22	1	U14	ADP3338-5	SOT-223HS		Analog Devices, Inc.	ADP3338-5
23	2	U3, U7	ADP3338-3.3	SOT-223HS		Analog Devices, Inc.	ADP3338-33
24	1	U8	SN75LVDT386	TSSOP64		Arrow Electronics, Inc.	SN75LVDT386DGG
25	1	U15	SN75LVDT390	SOIC16PW		Arrow Electronics, Inc.	SN75LVDT390PW
26	2	R4, R6	Resistor	402	36 $\Omega$	Digi-Key Corporation	P36JCT-ND
27	2	C1, C44, C55 <sup>1</sup>	Capacitor	TAJD	10 $\mu$ F	Digi-Key Corporation	478-1699-2
28	23	C13, C14, C16, C17, C18, C19, C29, C31, C36, C37, C41, C45, C49, C61, C69, C70, C72, C73, C75, C93, C108, C109, C110 <sup>1</sup>	CAP402	402	XX		
29	1	C98 <sup>1</sup>	Capacitor	805	10 $\mu$ F	Digi-Key Corporation	490-1717-1-ND
30		E15 <sup>1</sup>	Header	EHOLE		Mouser Electronics	517-6111TG
31		J5 <sup>1</sup>	SMA	SMA		Digi-Key Corporation	ARFX1231-ND
32		P6 <sup>1</sup>	Header	C40MS		Samtec, Inc.	TSW-120-08-L-D-RA
33	2	R1, R2 <sup>1</sup>	BRES402	402	XX		
34	3	R5, R7, R9 <sup>1</sup>	BRES402	402	XX		
35	1	U2 <sup>1</sup>	ECLOSC	DIP4(14)			

Item	Qty.	Reference Designator	Description	Package	Value	Manufacturer	Mfg. Part No.
36	4	H1, H2, H3, H4 <sup>1</sup>	MTHOLE6	MTHOLE6			
37	2	T1, T2 <sup>1</sup>	Balun transformer	SM-22		M/A-COM	ETC1-1-13
38	2	P21, P22 <sup>1</sup>	Term strip	PTMICRO4		Newark Electronics	

<sup>1</sup> Parts not populated.

**Table 12. AD9445-125 IF Customer Evaluation Board Bill of Materials**

Item	Qty.	Reference Designator	Description	Package	Value	Manufacturer	MFG_PART_NO
1	7	C4, C6, C33, C34, C87, C88, C89	Capacitor	TAJD	10 $\mu$ F	Digi-Key Corporation	478-1699-2
2	44	C2, C3, C5, C7, C8, C9, C10, C11, C12, C15, C20, C21, C22, C23, C26, C27, C28, C32, C35, C38, C40, C42, C43, C46, C47, C48, C50, C52, C53, C59, C60, C76, C77, C78, C82, C84, C85, C86, C90, C91, C94, C95, C96, C97	Capacitor	402	0.1 $\mu$ F	Digi-Key Corporation	PCC2146CT-ND
3	2	C30, C58	Capacitor	201	0.01 $\mu$ F	Digi-Key Corporation	445-1796-1-ND
4	4	C39, C56, C64, C65	Capacitor	TAJD	10 $\mu$ F	Digi-Key Corporation	478-1699-2
5	1	C51	Capacitor	805	10 $\mu$ F	Digi-Key Corporation	490-1717-1-ND
6	1	CR1	Diode	SOT23M5		Digi-Key Corporation	MA3X71600LCT-ND
7	1	CR2	Diode	SOT23M5		Digi-Key Corporation	MA3X71600LCT-ND
8	20	E1, E2, E3, E4, E5, E6, E9, E10, E14, E18, E19, E20, E24, E25, E26, E27, E30, E31, E36, E41	Header	EHOLE		Mouser Electronics	517-6111TG
9	2	J1, J4	SMA	SMA		Digi-Key Corporation	ARFX1231-ND
10	1	L1	Inductor	0603A	10 nH	Coilcraft, Inc.	0603CS-10NXGBU
11	3	L3, L4, L5	EMIFIL® BLM31PG500SN1L	1206MIL		Mouser Electronics	81-BLM31P500S
12	1	P4	PJ-002A	PJ-002A		Digi-Key Corporation	CP-002A-ND
13	1	P7	Header	C40MS		Samtec, Inc.	TSW-120-08-L-D-RA
14	1	R3	Resistor	402	3.74 k $\Omega$	Digi-Key Corporation	P3.74KLCT-ND
15	1	R8	Resistor	402	50 $\Omega$	Digi-Key Corporation	P49.9LCT-ND
16	4	R10, R19, R39, L2	Resistor	402	0 $\Omega$	Digi-Key Corporation	P0.0JCT-ND
17	1	R11	BRES402	402	1 k $\Omega$	Digi-Key Corporation	P1.0KLCT-ND
18	2	R28, R35	Resistor	402	33 $\Omega$	Digi-Key Corporation	P33JCT-ND
19	2	RZ4, RZ5	Resistor array	16PIN	22 $\Omega$	Digi-Key Corporation	742C163220JCT-ND
20	1	U1	AD9445BSVZ-125	SV-100-3		Analog Devices, Inc.	AD9445BSVZ-125
21	1	U14	ADP3338-5	SOT-223HS		Analog Devices, Inc.	ADP3338-5
22	2	U3, U7	ADP3338-3.3	SOT-223HS		Analog Devices, Inc.	ADP3338-3.3
23	1	U8	SN75LVDT386	TSSOP64		Arrow Electronics, Inc.	SN75LVDT386DGG
24	1	U15	SN75LVDT390	SOIC16PW		Arrow Electronics, Inc.	SN75LVDT390PW
25	2	T1, T2	Balun transformer	SM-22		M/A-COM	ETC-1-1-13
26	1	R5	Resistor	402	36 $\Omega$	Digi-Key Corporation	P49.9LCT-ND
27	1	T3	Transformer	ADT1-1WT		Mini-Circuits	ADT1-1WT
28	2	C1, C44, C55 <sup>1</sup>	Capacitor	TAJD	10 $\mu$ F	Digi-Key Corporation	478-1699-2

# AD9445

Item	Qty.	Reference Designator	Description	Package	Value	Manufacturer	MFG_PART_NO
29	23	C13, C14, C16, C17, C18, C19, C29, C31, C36, C37, C41, C45, C49, C61, C69, C70, C72, C73, C75, C93, C108, C109, C110 <sup>1</sup>	CAP402	402	XX		
30	1	C98 <sup>1</sup>	Capacitor	805	10 µF	Digi-Key Corporation	409-1717-1-ND
31		E15 <sup>1</sup>	Header	EHOLE		Mouser Electronics	517-6111TG
32		J5 <sup>1</sup>	SMA	SMA		Digi-Key Corporation	ARFX1231-ND
33		P6 <sup>1</sup>	Header	C40MS		Samtec, Inc.	TSW-120-08-L-D-RA
34	2	R1, R2 <sup>1</sup>	BRES402	402	XX		
35	3	R5, R7, R9 <sup>1</sup>	BRES402	402	XX		
36	1	U2 <sup>1</sup>	ECLOSC	DIP4(14)			
37	4	H1, H2, H3, H4 <sup>1</sup>	MTHOLE6	MTHOLE6			
38	2	R4, R6 <sup>1</sup>	Resistor	402	36	Digi-Key Corporation	P36JCT-ND
39	1	T5 <sup>1</sup>	Transformer	ADT1-1WT		Mini-Circuits	ADT1-1WT
40	2	P21, P22 <sup>1</sup>	Term strip	PTMICRO4		Newark Electronics	

<sup>1</sup> Parts not populated.

# OUTLINE DIMENSIONS

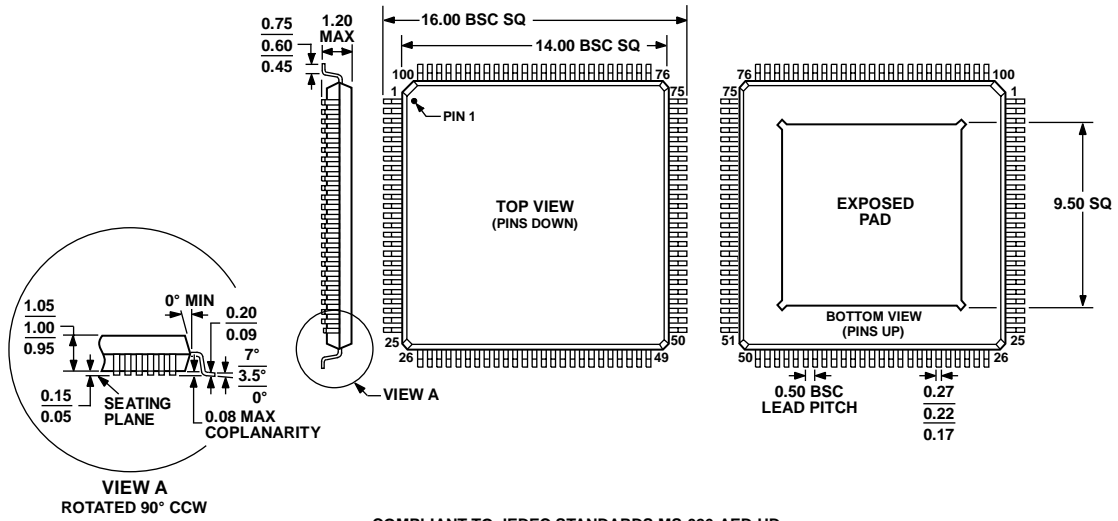

COMPLIANT TO JEDEC STANDARDS MS-026-AED-HD

**NOTES**

1. CENTER FIGURES ARE TYPICAL UNLESS OTHERWISE NOTED.
2. THE PACKAGE HAS A CONDUCTIVE HEAT SLUG TO HELP DISSIPATE HEAT AND ENSURE RELIABLE OPERATION OF THE DEVICE OVER THE FULL INDUSTRIAL TEMPERATURE RANGE. THE SLUG IS EXPOSED ON THE BOTTOM OF THE PACKAGE AND ELECTRICALLY CONNECTED TO CHIP GROUND. IT IS RECOMMENDED THAT NO PCB SIGNAL TRACES OR VIAS BE LOCATED UNDER THE PACKAGE THAT COULD COME IN CONTACT WITH THE CONDUCTIVE SLUG. ATTACHING THE SLUG TO A GROUND PLANE WILL REDUCE THE JUNCTION TEMPERATURE OF THE DEVICE WHICH MAY BE BENEFICIAL IN HIGH TEMPERATURE ENVIRONMENTS.

Figure 71. 100-Lead Thin Quad Flat Package, Exposed Pad [TQFP\_EP] (SV-100-3)  
Dimensions shown in millimeters

## ORDERING GUIDE

Model	Temperature Range	Package Description	Package Option
AD9445BSVZ-125 <sup>1</sup>	-40°C to +85°C	100-Lead TQFP_EP	SV-100-3
AD9445BSVZ-105 <sup>1</sup>	-40°C to +85°C	100-Lead TQFP_EP	SV-100-3
AD9445-IF-LVDS/PCB		AD9445-125 IF (>100 MHz) LVDS Mode Evaluation Board	
AD9445-BB-LVDS/PCB		AD9445-125 Baseband (<100 MHz) LVDS Mode Evaluation Board	

<sup>1</sup> Z = Pb-free part.

**AD9445**

**NOTES**

**NOTES**

**AD9445**

**NOTES**