

MITSUBISHI RF POWER TRANSISTOR 2SC1968A

NPN EPITAXIAL PLANAR TYPE

DESCRIPTION

2SC1968A is a silicon NPN epitaxial planar type transistor designed for RF power amplifiers on UHF band mobile radio applications.

FEATURES

- High power gain: $G_{pe} \geq 5.4\text{dB}$
@ $V_{CC} = 13.5\text{V}$, $P_O = 14\text{W}$, $f = 470\text{MHz}$
- Emitter ballasted construction and gold metallization for high reliability and good performances.
- Low thermal resistance ceramic package with flange.
- Ability of withstanding more than 20:1 load VSWR all phase when operated at $V_{CC} = 15.2\text{V}$, $P_O = 18\text{W}$, $f = 470\text{MHz}$.

APPLICATION

10 to 14 watts output power amplifiers in UHF band mobile radio applications.

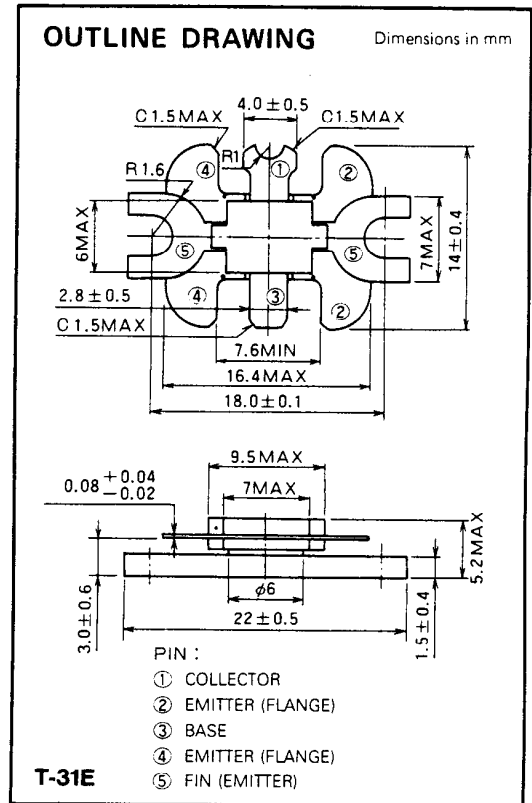

ABSOLUTE MAXIMUM RATINGS ($T_C = 25^\circ\text{C}$ unless otherwise specified)

Symbol	Parameter	Conditions	Ratings	Unit
V_{CB0}	Collector to base voltage		35	V
V_{EB0}	Emitter to base voltage		4	V
V_{CE0}	Collector to emitter voltage	$R_{BE} = \infty$	17	V
I_C	Collector current		5	A
P_C	Collector dissipation	$T_a = 25^\circ\text{C}$	3	W
		$T_C = 25^\circ\text{C}$	40	W
T_j	Junction temperature		175	$^\circ\text{C}$
T_{stg}	Storage temperature		-65 to 175	$^\circ\text{C}$
R_{th-a}	Thermal resistance	Junction to ambient	50	$^\circ\text{C/W}$
R_{th-c}		Junction to case	3.75	$^\circ\text{C/W}$

Note. Above parameters are guaranteed independently.

ELECTRICAL CHARACTERISTICS ($T_C = 25^\circ\text{C}$ unless otherwise specified)

Symbol	Parameter	Test conditions	Limits			Unit
			Min	Typ	Max	
$V_{(BR)EBO}$	Emitter to base breakdown voltage	$I_E = 10\text{mA}$, $I_C = 0$	4			V
$V_{(BR)CBO}$	Collector to base breakdown voltage	$I_C = 10\text{mA}$, $I_E = 0$	35			V
$V_{(BR)CEO}$	Collector to emitter breakdown voltage	$I_C = 50\text{mA}$, $R_{BE} = \infty$	17			V
I_{CBO}	Collector cutoff current	$V_{CB} = 15\text{V}$, $I_E = 0$			500	μA
I_{EBO}	Emitter cutoff current	$V_{EB} = 2\text{V}$, $I_C = 0$			400	μA
h_{FE}	DC forward current gain*	$V_{CE} = 10\text{V}$, $I_C = 0.1\text{A}$	10	50	180	—
P_O	Output power	$V_{CC} = 13.5\text{V}$, $P_{in} = 4\text{W}$, $f = 470\text{MHz}$	14	16		W
η_C	Collector efficiency		50	60		%

Note. * Pulse test, $P_W = 150\mu\text{s}$, duty = 5%.

Above parameters, ratings, limits and conditions are subject to change.

TEST CIRCUIT

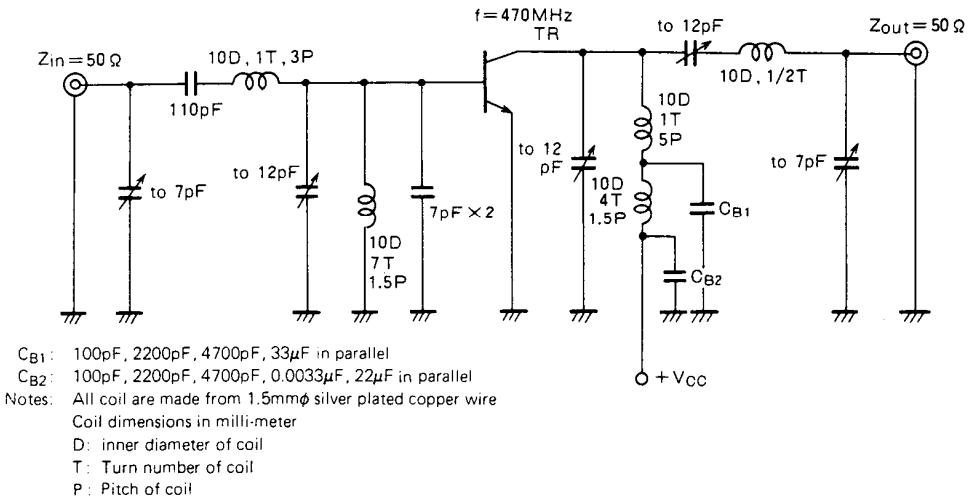

TYPICAL PERFORMANCE DATA

COLLECTOR DISSIPATION VS. AMBIENT TEMPERATURE

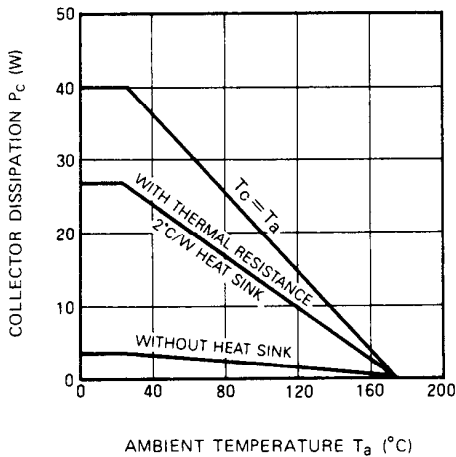

COLLECTOR CURRENT VS. COLLECTOR TO EMITTER VOLTAGE

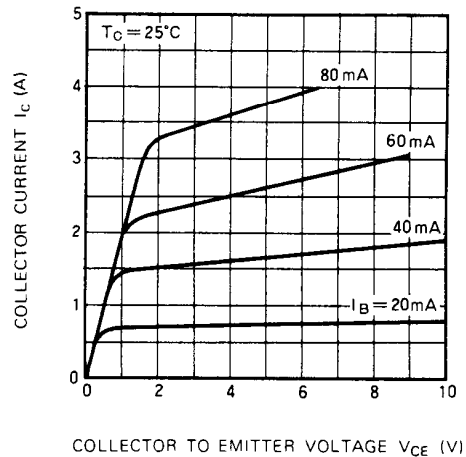

DC CURRENT GAIN VS. COLLECTOR CURRENT

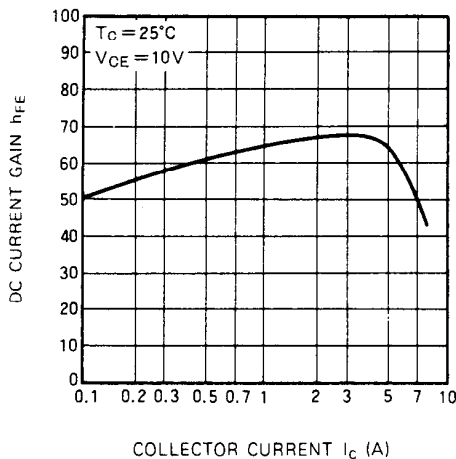

COLLECTOR TO EMITTER BREAKDOWN VOLTAGE VS. BASE TO EMITTER RESISTANCE

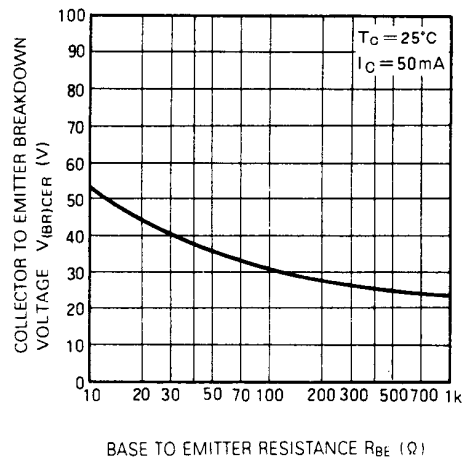

NPN EPITAXIAL PLANAR TYPE

COLLECTOR OUTPUT CAPACITANCE VS. COLLECTOR TO BASE VOLTAGE

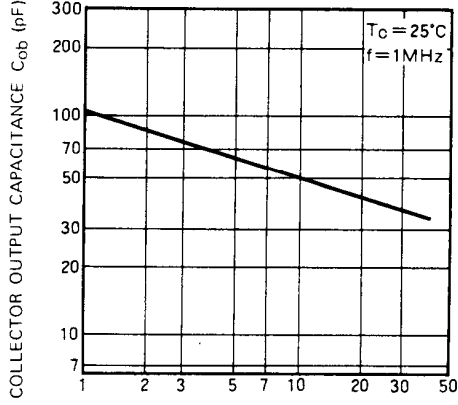

COLLECTOR TO BASE VOLTAGE V_{CB} (V)

OUTPUT POWER, COLLECTOR EFFICIENCY VS. INPUT POWER

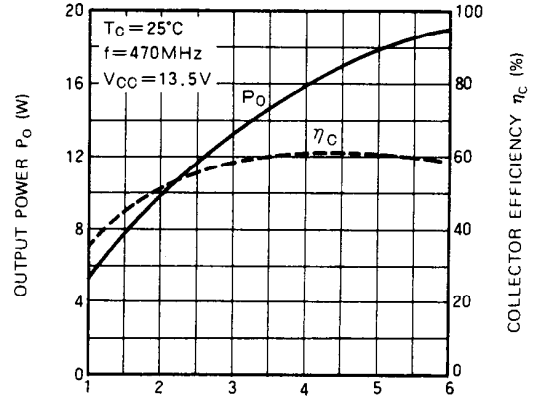

INPUT POWER P_{in} (W)

OUTPUT POWER VS. COLLECTOR SUPPLY VOLTAGE

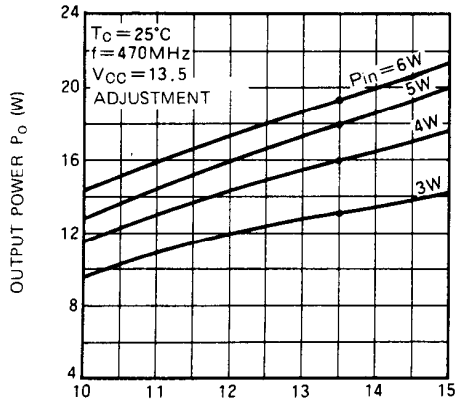

COLLECTOR SUPPLY VOLTAGE V_{CC} (V)