

### FEATURES

- **COMMON MODE TRANSIENT IMMUNITY**  
CMH: 2000 V/μs MIN, CML: 2000 V/μs MIN
- **HIGH ISOLATION VOLTAGE**  
BV: 5000 V<sub>r.m.s.</sub> MIN
- **HIGH SPEED RESPONSE**  
t<sub>PLH</sub>, t<sub>PHL</sub>: 0.5 μs MAX
- **LOW INPUT CURRENT**  
IFLH: 3 mA MAX @ V<sub>CC</sub> = 24 V, T<sub>A</sub> = 25 °C  
IFLH: 5 mA MAX @ V<sub>CC</sub> = 24 V, T<sub>A</sub> = -25 °C to +85 °C

### DESCRIPTION

PS9636 and PS9636L are optically coupled isolators containing a GaAlAs LED on the light emitting side (input side) and a photodiode and a signal processing circuit on the light receiving side (output side) on one chip. PS9636 is in a plastic DIP (Dual In-line Package) and PS9636L is in a lead bending type (Gull-wing) for surface mount.

### APPLICATIONS

- INVERTER/MOSFET
- AIR CONDITIONER

### ELECTRICAL CHARACTERISTICS (T<sub>A</sub> = -20 °C to +85 °C, unless otherwise specified)

		PART NUMBER		PS9636, PS9636L		
	SYMBOLS	PARAMETERS	UNITS	MIN	TYP	MAX
Diode	V <sub>F</sub>	Forward Voltage, I <sub>F</sub> = 10 mA, T <sub>A</sub> = 25 °C	V	1.4	1.6	1.8
	I <sub>R</sub>	Reverse Current, V <sub>R</sub> = 5 V, T <sub>A</sub> = 25 °C	μA			10
	C <sub>i</sub>	Capacitance, V = 0, f = 1 MHz, T <sub>A</sub> = 25 °C	pF		30	
	V <sub>CC</sub>	Supply Voltage		15		35
Detector	V <sub>O1L</sub>	Low Level Output Voltage (O1) V <sub>CC1</sub> = 12 V, V <sub>CC2</sub> = -12 V, I <sub>F</sub> = 5 mA, I <sub>O1</sub> = 0.1 A	V		0.1	0.4
	V <sub>O2H</sub>	High Level Output Voltage (O2), V <sub>CC</sub> = V <sub>O1</sub> = 24 V, I <sub>F</sub> = 5 mA, I <sub>O2</sub> = -0.1 A	V	18	21	
	V <sub>O2L</sub>	Low Level Output Voltage (O2), V <sub>CC</sub> = 24 V, I <sub>F</sub> = 0, I <sub>O2</sub> = 0.1 A	V		1.0	2
	I <sub>O1L</sub>	Leak Current (O1), I <sub>F</sub> = 0, V <sub>CC</sub> = V <sub>O1</sub> = 35 V, T <sub>A</sub> = 25 °C	μA			500
	I <sub>O2L</sub>	Leak Current (O2), I <sub>F</sub> = 5 mA, V <sub>CC</sub> = V <sub>O2</sub> = 35 V, T <sub>A</sub> = 25 °C	μA			500
	I <sub>CCH1</sub>	High Level Supply Current, V <sub>CC</sub> = 24 V, I <sub>F</sub> = 5 mA, T <sub>A</sub> = 25 °C	mA		8.5	13
	I <sub>CCH2</sub>	High Level Supply Current, V <sub>CC</sub> = 24 V, I <sub>F</sub> = 5 mA	mA			17
	I <sub>CCL1</sub>	Low Level Supply Current, V <sub>CC</sub> = 24 V, I <sub>F</sub> = 0, T <sub>A</sub> = 25 °C	mA		8	13
Coupled	I <sub>CCL2</sub>	Low Level Supply Current, V <sub>CC</sub> = 24 V, I <sub>F</sub> = 0	mA			17
	I <sub>FLH1</sub>	Threshold Input Current, Low → High, V <sub>CC</sub> = 24 V, T <sub>A</sub> = 25 °C	mA	0.1	0.4	3
	I <sub>FLH2</sub>	Threshold Input Current, Low → High, V <sub>CC</sub> = 24 V	mA			5
	R <sub>1-2</sub>	Isolation Resistance, V <sub>in-out</sub> = 1 kV <sub>DC</sub> , RH = 40 to 60%, T <sub>A</sub> = 25 °C	Ω	10 <sup>11</sup>		
	t <sub>PLH</sub>	Propagation Delay Time, Low → High V <sub>CC</sub> = 24 V, I <sub>F</sub> = 5 mA, T <sub>A</sub> = 25 °C, C <sub>G</sub> = 3000 pF, R <sub>G</sub> = 47 Ω	μs		0.3	0.5
	t <sub>PHL</sub>	Propagation Delay Time, High → Low V <sub>CC</sub> = 24 V, I <sub>F</sub> = 5 mA, R <sub>G</sub> = 47 Ω, C <sub>G</sub> = 3000 pF, T <sub>A</sub> = 25 °C	μs		0.1	0.5
	t <sub>r</sub>	Rise Time, V <sub>CC</sub> = 24 V, I <sub>F</sub> = 5 mA, T <sub>A</sub> = 25 °C, C <sub>G</sub> = 3000 pF, R <sub>G</sub> = 47 Ω	μs		0.3	0.5
	t <sub>f</sub>	Fall Time, V <sub>CC</sub> = 24 V, I <sub>F</sub> = 5 mA, T <sub>A</sub> = 25 °C, R <sub>G</sub> = 47 Ω, C <sub>G</sub> = 3000 pF	μs		0.1	0.5
	CMH	Common Mode Transient Immunity High Output Level V <sub>CM</sub> = 600 V (peak), T <sub>A</sub> = 25 °C, I <sub>F</sub> = 5 mA, V <sub>CC</sub> = 24 V, ΔV <sub>O2H</sub> = 2 V	V/μs	2000		
CML	Common Mode Transient Immunity Low Output Level V <sub>CM</sub> = 600 V (peak), T <sub>A</sub> = 25 °C, I <sub>F</sub> = 0, V <sub>CC</sub> = 24 V, ΔV <sub>O2L</sub> = 2 V	V/μs	2000			

**ABSOLUTE MAXIMUM RATINGS<sup>1</sup>** (T<sub>A</sub> = 25°C)

SYMBOLS	PARAMETERS	UNITS	RATINGS
<b>Diode</b>			
I <sub>F</sub>	Forward Current	mA	30
V <sub>R</sub>	Reverse Voltage	V	6
<b>Detector</b>			
V <sub>CC</sub>	Supply Voltage	V	35
I <sub>O1</sub>	Output Current (O1)	A	0.1
I <sub>O1P</sub>	Peak Output Current (O1) <sup>3</sup>	A	0.4
I <sub>O2</sub>	Output Current (O2)	A	0.1
I <sub>O2P</sub>	Peak Output Current (O2) <sup>3</sup>	A	0.4
V <sub>O1</sub>	Output Voltage (O1)	V	35
P <sub>O</sub>	Power Dissipation	mW	500
<b>Coupled</b>			
P <sub>T</sub>	Total Power Dissipation	mW	550
BV	Isolation Voltage <sup>2</sup>	V <sub>r.m.s.</sub>	5000
T <sub>OP</sub>	Operating Temperature	°C	-25 to +85
T <sub>STG</sub>	Storage Temperature	°C	-55 to +125

Notes:

1. Operation in excess of any one of these parameters may result in permanent damage.
2. AC voltage for 1 minute at T<sub>A</sub> = 25 °C, RH = 60 % between input and output.
3. PW ≤ 2.0 μs, Duty cycle 1 %.

**RECOMMENDED OPERATING CONDITIONS**

SYMBOLS	PARAMETERS	UNITS	MIN	TYP	MAX
I <sub>FLH</sub>	Forward Current	mV	7		10
V <sub>CC</sub>	Supply Voltage	V	20		30
I <sub>O1</sub>	Output Current (O1)	A			0.1
I <sub>O2</sub>	Output Current (O2)	A			0.1
T <sub>OP</sub>	Operating Current	°C			+70



**OUTLINE DIMENSIONS** (Units in mm)

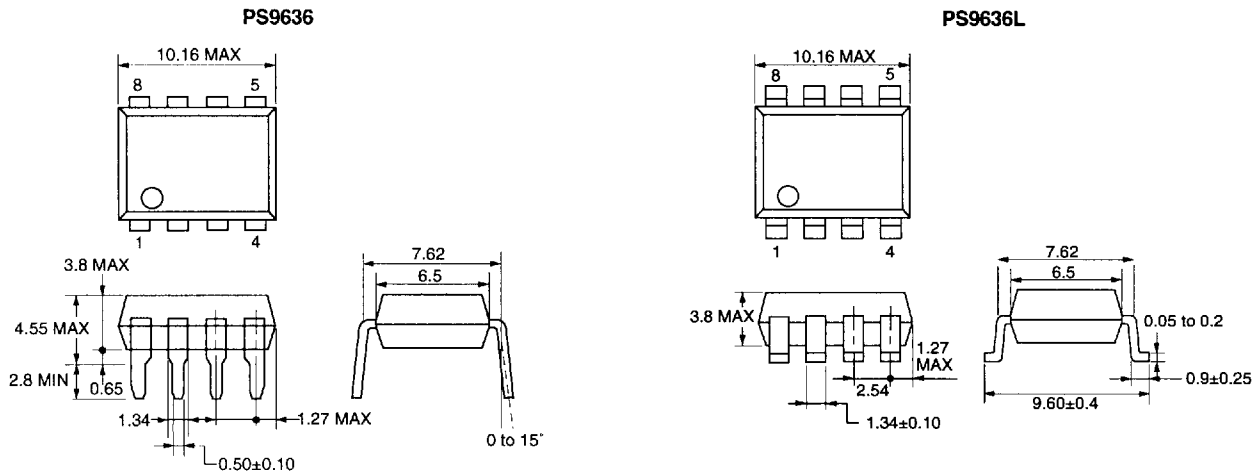

**PIN CONNECTION** (Top View)

PS9636, PS9636L

Signal processing circuit

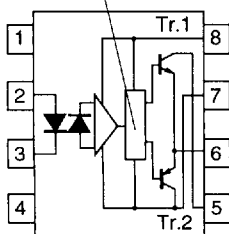

1. NC
2. Anode
3. Cathode
4. NC
5. Output (O1)
6. Output (O2)
7. GND
8. V<sub>CC</sub>

MEASUREMENT CIRCUITS FOR ELECTRICAL CHARACTERISTICS

FIG. 1 (Vo1L)

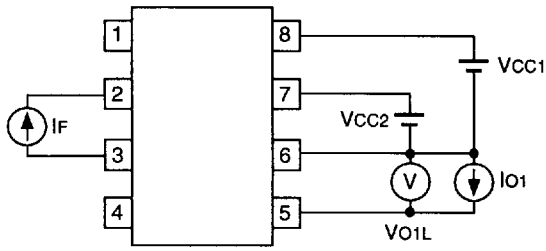

FIG. 2 (Vo2H)

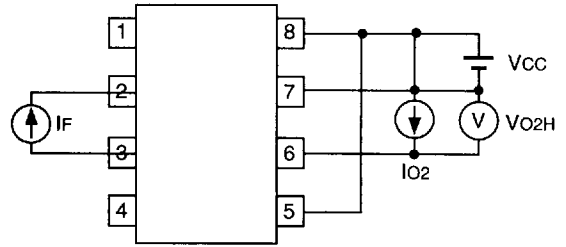

FIG. 3 (Vo2L)

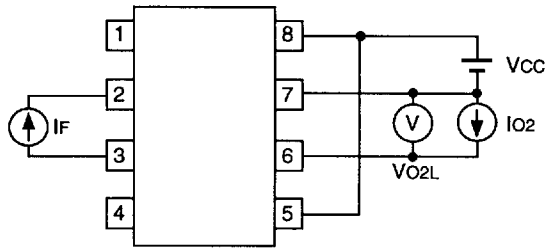

FIG. 4 (Io1L)

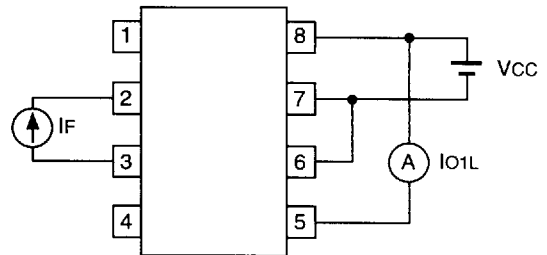

FIG. 5 (Io2L)

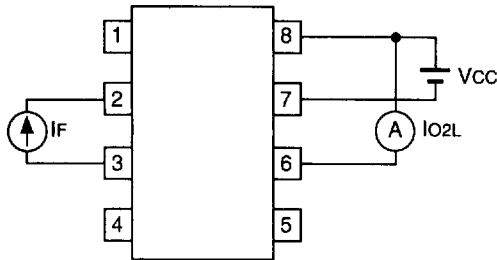

FIG. 6 (IcCL, IcCH)

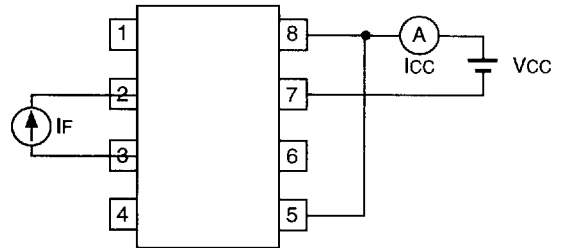

FIG. 7 (IFLH)

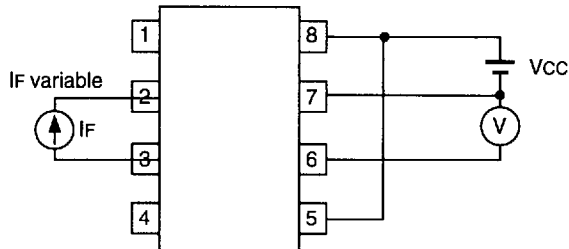
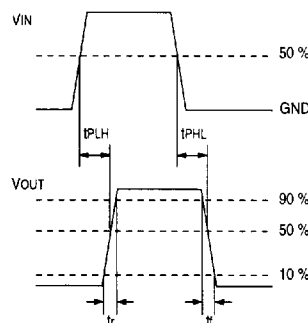
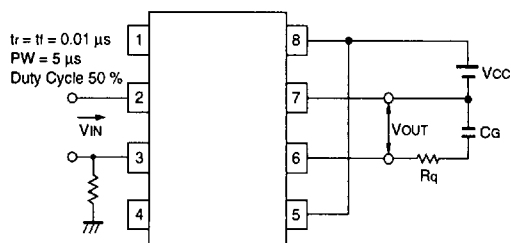
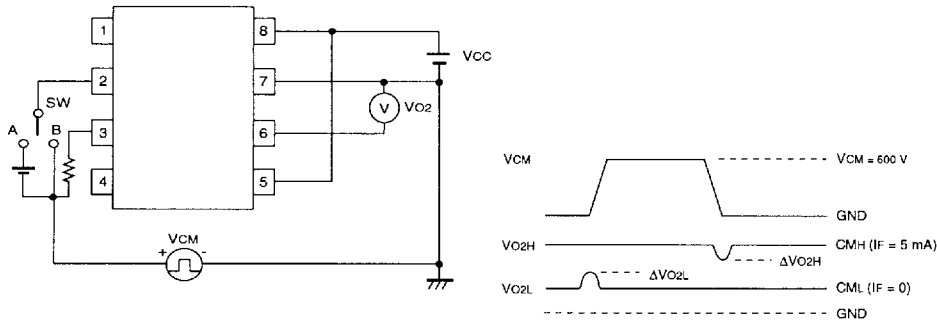

FIG. 8 (tPLH, tPHL)



MEASUREMENT CIRCUITS FOR ELECTRICAL CHARACTERISTICS (con't)

FIG. 9 (CMH, CML)



1