

# MC74AC377, MC74ACT377

## Octal D Flip-Flop with Clock Enable

The MC74AC377/74ACT377 has eight edge-triggered, D-type flip-flops with individual D inputs and Q outputs. The common buffered Clock (CP) input loads all flip-flops simultaneously, when the Clock Enable (CE) is LOW. The register is fully edge-triggered. The state of each D input, one setup time before the LOW-to-HIGH clock transition, is transferred to the corresponding flip-flop's Q output. The CE input must be stable only one setup time prior to the LOW-to-HIGH clock transition for predictable operation.

- Ideal for Addressable Register Applications
- Clock Enable for Address and Data Synchronization Applications
- Eight Edge-Triggered D Flip-Flops
- Buffered Common Clock
- Outputs Source/Sink 24 mA
- See MC74AC273 for Master Reset Version
- See MC74AC373 for Transparent Latch Version
- See MC74AC374 for 3-State Version
- ACT377 Has TTL Compatible Inputs
- MSL = 1 for all Surface Mount
- Chip Complexity: 292 FETS or 73 Gates



**ON Semiconductor™**

<http://onsemi.com>

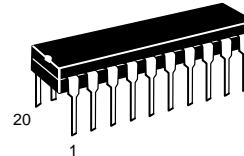

**PDIP-20  
N SUFFIX  
CASE 738**

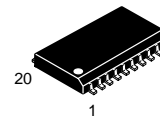

**SO-20  
DW SUFFIX  
CASE 751**

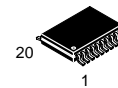

**TSSOP-20  
DT SUFFIX  
CASE 948E**

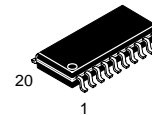

**EIAJ-20  
M SUFFIX  
CASE 967**

### ORDERING INFORMATION

See detailed ordering and shipping information in the package dimensions section on page 7 of this data sheet.

### DEVICE MARKING INFORMATION

See general marking information in the device marking section on page 8 of this data sheet.

# MC74AC377, MC74ACT377

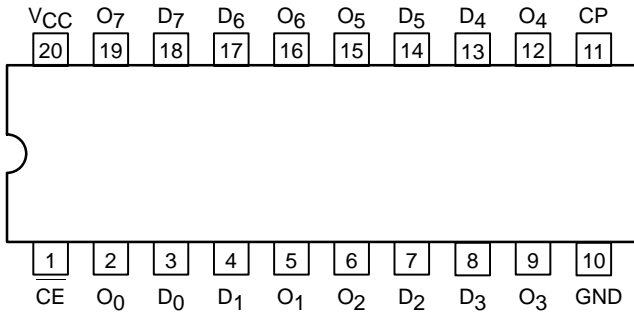

**Figure 1. Pinout: 20-Lead Packages Conductors (Top View)**

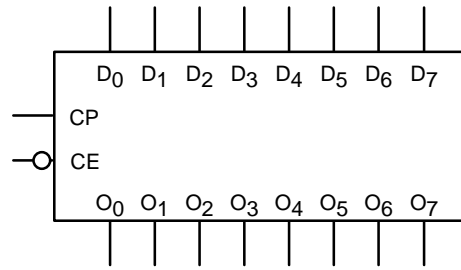

**Figure 2. LOGIC SYMBOL**

## PIN NAMES

PIN	FUNCTION
D <sub>0</sub> -D <sub>7</sub>	Data Inputs
$\overline{CE}$	Clock Enable (Active LOW)
Q <sub>0</sub> -Q <sub>7</sub>	Data Outputs
CP	Clock Pulse Input

## MODE SELECT-FUNCTION TABLE

Operating Mode	Inputs			Outputs
	CP	CE	D <sub>n</sub>	Q <sub>n</sub>
Load '1'	$\lrcorner$	L	H	H
Load '0'	$\lrcorner$	L	L	L
Hold (Do Nothing)	$\lrcorner$	H	X	No Change
	X	H	X	No Change

H = HIGH Voltage Level  
 L = LOW Voltage Level  
 X = Immaterial  
 $\lrcorner$  = LOW-to-HIGH Clock Transition

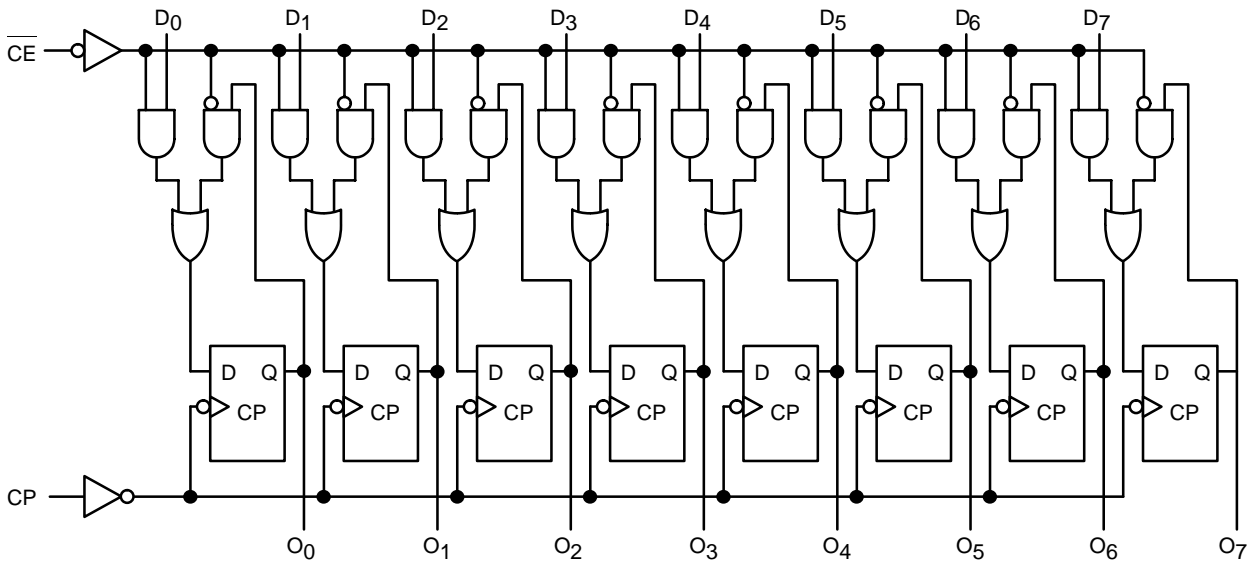

Please note that this diagram is provided only for the understanding of logic operations and should not be used to estimate propagation delays.

**Figure 3. LOGIC DIAGRAM**

# MC74AC377, MC74ACT377

## MAXIMUM RATINGS\*

Symbol	Parameter	Value	Unit
V <sub>CC</sub>	DC Supply Voltage (Referenced to GND)	-0.5 to +7.0	V
V <sub>in</sub>	DC Input Voltage (Referenced to GND)	-0.5 to V <sub>CC</sub> +0.5	V
V <sub>out</sub>	DC Output Voltage (Referenced to GND)	-0.5 to V <sub>CC</sub> +0.5	V
I <sub>in</sub>	DC Input Current, per Pin	±20	mA
I <sub>out</sub>	DC Output Sink/Source Current, per Pin	±50	mA
I <sub>CC</sub>	DC V <sub>CC</sub> or GND Current per Output Pin	±50	mA
T <sub>stg</sub>	Storage Temperature	-65 to +150	°C
θ <sub>JA</sub>	Thermal Resistance (Junction to Ambient)	SOIC, DW TSSOP, DT PDIP, N 97 129 69	°C/W
V <sub>ESD</sub>	ESD Withstand Voltage	Human Body Model (Note 1) Machine Model (Note 2) Charged Device Model (Note 3) > 2000 > 200 > 1000	V
I <sub>Latch-Up</sub>	Latch-Up Performance	V <sub>CC</sub> = 5.5 V; TA = 125°C (Note 4)	> 100 mA

\* Maximum Ratings are those values beyond which damage to the device may occur. Functional operation should be restricted to the Recommended Operating Conditions.

1. Tested to EIA/JESD22-A114-A
2. Tested to EIA/JESD22-A115-A
3. Tested to JESD22-C101-A
4. Tested to EIA/JESD78

## RECOMMENDED OPERATING CONDITIONS

Symbol	Parameter	Min	Typ	Max	Unit	
V <sub>CC</sub>	Supply Voltage	'AC	2.0	5.0	6.0	V
		'ACT	4.5	5.0	5.5	
V <sub>in</sub> , V <sub>out</sub>	DC Input Voltage, Output Voltage (Ref. to GND)	0		V <sub>CC</sub>	V	
t <sub>r</sub> , t <sub>f</sub>	Input Rise and Fall Time (Note 5) 'AC Devices except Schmitt Inputs	V <sub>CC</sub> @ 3.0 V		150		ns/V
		V <sub>CC</sub> @ 4.5 V		40		
		V <sub>CC</sub> @ 5.5 V		25		
t <sub>r</sub> , t <sub>f</sub>	Input Rise and Fall Time (Note 6) 'ACT Devices except Schmitt Inputs	V <sub>CC</sub> @ 4.5 V		10		ns/V
		V <sub>CC</sub> @ 5.5 V		8.0		
T <sub>J</sub>	Junction Temperature (PDIP)			140	°C	
T <sub>A</sub>	Operating Ambient Temperature Range	-40	25	85	°C	
I <sub>OH</sub>	Output Current — High			-24	mA	
I <sub>OL</sub>	Output Current — Low			24	mA	

5. V<sub>in</sub> from 30% to 70% V<sub>CC</sub>; see individual Data Sheets for devices that differ from the typical input rise and fall times.
6. V<sub>in</sub> from 0.8 V to 2.0 V; see individual Data Sheets for devices that differ from the typical input rise and fall times.

# MC74AC377, MC74ACT377

## 74AC – DC CHARACTERISTICS

Symbol	Parameter	V <sub>CC</sub> (V)	T <sub>A</sub> = +25°C		T <sub>A</sub> = -40°C to +85°C		Unit	Conditions
			Typ	Guaranteed Limits				
V <sub>IH</sub>	Minimum High Level Input Voltage	3.0	1.50	2.10	2.10	V	V <sub>OUT</sub> = 0.1 V or V <sub>CC</sub> - 0.1 V	
		4.5	2.25	3.15	3.15	V		
		5.5	2.75	3.85	3.85	V		
V <sub>IL</sub>	Maximum Low Level Input Voltage	3.0	1.50	0.90	0.90	V	V <sub>OUT</sub> = 0.1 V or V <sub>CC</sub> - 0.1 V	
		4.5	2.25	1.35	1.35	V		
		5.5	2.75	1.65	1.65	V		
V <sub>OH</sub>	Minimum High Level Output Voltage	3.0	2.99	2.9	2.9	V	I <sub>OUT</sub> = -50 μA	
		4.5	4.49	4.4	4.4	V		
		5.5	5.49	5.4	5.4	V		
	3.0		2.56	2.46	V	*V <sub>IN</sub> = V <sub>IL</sub> or V <sub>IH</sub> I <sub>OH</sub>		
	4.5		3.86	3.76	V			
	5.5		4.86	4.76	V			
V <sub>OL</sub>	Maximum Low Level Output Voltage	3.0	0.002	0.1	0.1	V	I <sub>OUT</sub> = 50 μA	
		4.5	0.001	0.1	0.1	V		
		5.5	0.001	0.1	0.1	V		
	3.0		0.36	0.44	V	*V <sub>IN</sub> = V <sub>IL</sub> or V <sub>IH</sub> I <sub>OH</sub>		
	4.5		0.36	0.44	V			
	5.5		0.36	0.44	V			
I <sub>IN</sub>	Maximum Input Leakage Current	5.5		±0.1	±1.0	μA	V <sub>I</sub> = V <sub>CC</sub> , GND	
I <sub>OLD</sub>	Maximum Input Leakage Current	5.5			75	mA	V <sub>OLD</sub> = 1.65 V Max V <sub>OHD</sub> = 3.85 V Min	
I <sub>OHD</sub>		5.5			-75	mA		
I <sub>CC</sub>	Maximum Quiescent Supply Current	5.5		8.0	80	μA	V <sub>IN</sub> = V <sub>CC</sub> or GND	

\*All outputs loaded; thresholds on input associated with output under test.

†Maximum test duration 2.0 ms, one output loaded at a time.

NOTE: I<sub>IN</sub> and I<sub>CC</sub> @ 3.0 V are guaranteed to be less than or equal to the respective limit @ 5.5 V V<sub>CC</sub>.

## 74AC – AC CHARACTERISTICS For Figures and Waveforms, See Figures 4, 5, and 6.

Symbol	Parameter	V <sub>CC</sub> * (V)	T <sub>A</sub> = +25°C C <sub>L</sub> = 50 pF			T <sub>A</sub> = -40°C to +85°C C <sub>L</sub> = 50 pF		Unit
			Min	Typ	Max	Min	Max	
f <sub>max</sub>	Maximum Clock Frequency	3.3 5.0	90 140			75 125		MHz
t <sub>PLH</sub>	Propagation Delay CP to Q <sub>n</sub>	3.3 5.0	3.0 2.0		13.0 9.0	1.5 1.5	14.0 10.0	ns
t <sub>PHL</sub>	Propagation Delay CP to Q <sub>n</sub>	3.3 5.0	3.5 2.5		13.0 10.0	2.0 1.5	14.5 11.0	ns

\* Voltage Range 3.3 V is 3.3 V ±0.3 V; Voltage Range 5.0 V is 5.0 V ±0.5 V.

## 74AC – AC OPERATING REQUIREMENTS

Symbol	Parameter	V <sub>CC</sub> * (V)	T <sub>A</sub> = +25°C C <sub>L</sub> = 50 pF		T <sub>A</sub> = -40°C to +85°C		Unit
			Typ	Guaranteed Minimum			
t <sub>s</sub>	Setup Time, HIGH or LOW D <sub>n</sub> to CP	3.3 5.0		5.5 4.0	6.0 4.5		ns
t <sub>h</sub>	Hold Time, HIGH or LOW D <sub>n</sub> to CP	3.3 5.0		0 1.0	0 1.0		ns
t <sub>s</sub>	Setup Time, HIGH or LOW $\overline{\text{CE}}$ to CP	3.3 5.0		6.0 4.0	7.5 4.5		ns
t <sub>h</sub>	Hold Time, HIGH or LOW $\overline{\text{CE}}$ to CP	3.3 5.0		0 1.0	0 1.0		ns
t <sub>w</sub>	CP Pulse Width HIGH or LOW	3.3 5.0		5.5 4.0	6.0 4.5		ns

\* Voltage Range 3.3 V is 3.3 V ±0.3 V; Voltage Range 5.0 V is 5.0 V ±0.5 V.

# MC74AC377, MC74ACT377

## 74ACT – DC CHARACTERISTICS

Symbol	Parameter	V <sub>CC</sub> (V)	T <sub>A</sub> = +25°C		T <sub>A</sub> = -40°C to +85°C		Unit	Conditions
			Typ	Guaranteed Limits				
V <sub>IH</sub>	Minimum High Level Input Voltage	4.5 5.5	1.5 1.5	2.0 2.0	2.0 2.0	V	V <sub>OUT</sub> = 0.1 V or V <sub>CC</sub> - 0.1 V	
V <sub>IL</sub>	Maximum Low Level Input Voltage	4.5 5.5	1.5 1.5	0.8 0.8	0.8 0.8	V	V <sub>OUT</sub> = 0.1 V or V <sub>CC</sub> - 0.1 V	
V <sub>OH</sub>	Minimum High Level Output Voltage	4.5 5.5	4.49 5.49	4.4 5.4	4.4 5.4	V	I <sub>OUT</sub> = -50 μA	
		4.5 5.5		3.86 4.86	3.76 4.76	V	*V <sub>IN</sub> = V <sub>IL</sub> or V <sub>IH</sub> -24 mA I <sub>OH</sub> -24 mA	
V <sub>OL</sub>	Maximum Low Level Output Voltage	4.5 5.5	0.001 0.001	0.1 0.1	0.1 0.1	V	I <sub>OUT</sub> = 50 μA	
		4.5 5.5		0.36 0.36	0.44 0.44	V	*V <sub>IN</sub> = V <sub>IL</sub> or V <sub>IH</sub> -24 mA I <sub>OH</sub> -24 mA	
I <sub>IN</sub>	Maximum Input Leakage Current	5.5		±0.1	±1.0	μA	V <sub>I</sub> = V <sub>CC</sub> , GND	
ΔI <sub>CC</sub> T	Additional Max. I <sub>CC</sub> /Input	5.5	0.6		1.5	mA	V <sub>I</sub> = V <sub>CC</sub> - 2.1 V	
I <sub>OLD</sub> I <sub>OHD</sub>	†Minimum Dynamic Output Current	5.5			75 -75	mA	V <sub>OLD</sub> = 1.65 V Max V <sub>OHD</sub> = 3.85 V Min	
I <sub>CC</sub>	Maximum Quiescent Supply Current	5.5		8.0	80	μA	V <sub>IN</sub> = V <sub>CC</sub> or GND	

\*All outputs loaded; thresholds on input associated with output under test.

†Maximum test duration 2.0 ms, one output loaded at a time.

## 74ACT – AC CHARACTERISTICS For Figures and Waveforms — See Figures 4, 5, and 6.

Symbol	Parameter	V <sub>CC</sub> * (V)	T <sub>A</sub> = +25°C C <sub>L</sub> = 50 pF			T <sub>A</sub> = -40°C to +85°C C <sub>L</sub> = 50 pF		Unit
			Min	Typ	Max	Min	Max	
f <sub>max</sub>	Maximum Clock Frequency	5.0	140			125		MHz
t <sub>PLH</sub>	Propagation Delay CP to Q <sub>n</sub>	5.0	3.0		9.0	2.5	10	ns
t <sub>PHL</sub>	Propagation Delay CP to Q <sub>n</sub>	5.0	3.5		10	2.5	11	ns

\*Voltage Range 5.0 V is 5.0 V ±0.5 V.

## 74ACT – AC OPERATING REQUIREMENTS

Symbol	Parameter	V <sub>CC</sub> * (V)	T <sub>A</sub> = +25°C C <sub>L</sub> = 50 pF		T <sub>A</sub> = -40°C to +85°C C <sub>L</sub> = 50 pF		Unit
			Typ	Guaranteed Minimum			
t <sub>s</sub>	Setup Time, HIGH or LOW D <sub>n</sub> to CP	5.0	5.0	4.5	5.5	ns	
t <sub>h</sub>	Hold Time, HIGH or LOW D <sub>n</sub> to CP	5.0	5.0	1.0	1.0	ns	
t <sub>s</sub>	Setup Time, HIGH or LOW CE to CP	5.0	5.0	4.5	5.5	ns	
t <sub>h</sub>	Hold Time, HIGH or LOW CE to CP	5.0	5.0	1.0	1.0	ns	
t <sub>w</sub>	CP Pulse Width HIGH or LOW	5.0	5.0	4.0	4.5	ns	

\*Voltage Range 5.0 V is 5.0 V ±0.5 V.

# MC74AC377, MC74ACT377

## CAPACITANCE

Symbol	Parameter	Value Typ	Unit	Test Conditions
$C_{IN}$	Input Capacitance	4.5	pF	$V_{CC} = 5.0\text{ V}$
$C_{PD}$	Power Dissipation Capacitance	90	pF	$V_{CC} = 5.0\text{ V}$

## SWITCHING WAVEFORMS

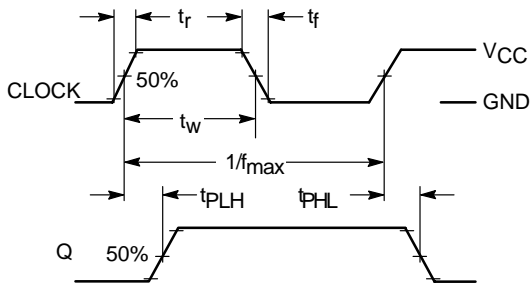

Figure 4.

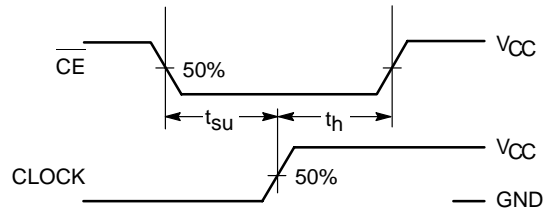

Figure 5.

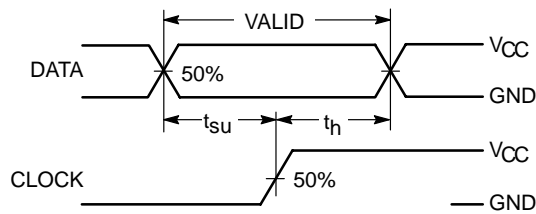
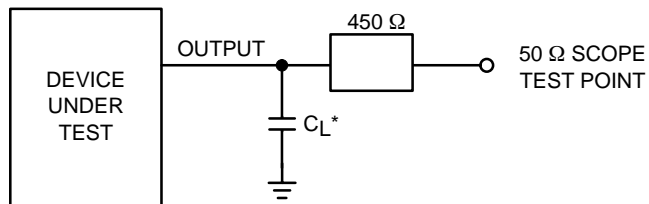

Figure 6.



\*Includes all probe and jig capacitance

Figure 7. Test Circuit

# MC74AC377, MC74ACT377

## ORDERING INFORMATION

Device	Package	Shipping
MC74AC377N	PDIP-20	18 Units/Rail
MC74ACT377N	PDIP-20	18 Units/Rail
MC74AC377DW	SOIC-20	38 Units/Rail
MC74AC377DWR2	SOIC-20	1000 Tape & Reel
MC74ACT377DW	SOIC-20	38 Units/Rail
MC74ACT377DWR2	SOIC-20	1000 Tape & Reel
MC74AC377DT	TSSOP-20	75 Units/Rail
MC74AC377DTR2	TSSOP-20	2500 Tape & Reel
MC74ACT377DT	TSSOP-20	75 Units/Rail
MC74ACT377DTR2	TSSOP-20	2500 Tape & Reel
MC74AC377M	EIAJ-20	40 Units/Rail
MC74AC377MEL	EIAJ-20	2000 Tape & Reel
MC74ACT377M	EIAJ-20	40 Units/Rail
MC74ACT377MEL	EIAJ-20	2000 Tape & Reel

# MC74AC377, MC74ACT377

## MARKING DIAGRAMS

PDIP-20



SO-20



TSSOP-20

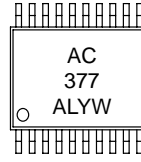

EIAJ-20

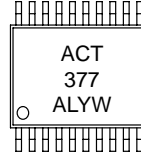

A = Assembly Location  
WL, L = Wafer Lot  
YY, Y = Year  
WW, W = Work Week



# MC74AC377, MC74ACT377

## PACKAGE DIMENSIONS

**PDIP-20**  
**N SUFFIX**  
 20 PIN PLASTIC DIP PACKAGE  
 CASE 738-03  
 ISSUE E

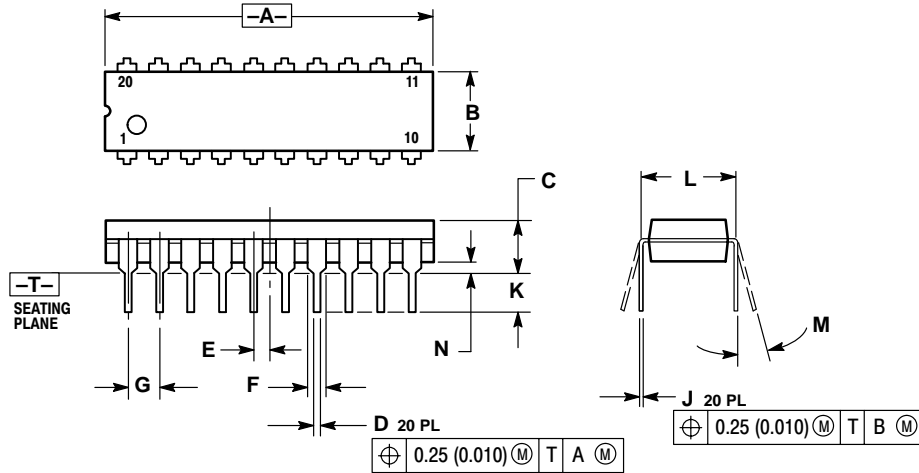

- NOTES:
1. DIMENSIONING AND TOLERANCING PER ANSI Y14.5M, 1982.
  2. CONTROLLING DIMENSION: INCH.
  3. DIMENSION L TO CENTER OF LEAD WHEN FORMED PARALLEL.
  4. DIMENSION B DOES NOT INCLUDE MOLD FLASH.

DIM	INCHES		MILLIMETERS	
	MIN	MAX	MIN	MAX
A	1.010	1.070	25.66	27.17
B	0.240	0.260	6.10	6.60
C	0.150	0.180	3.81	4.57
D	0.015	0.022	0.39	0.55
E	0.050 BSC		1.27 BSC	
F	0.050	0.070	1.27	1.77
G	0.100 BSC		2.54 BSC	
J	0.008	0.015	0.21	0.38
K	0.110	0.140	2.80	3.55
L	0.300 BSC		7.62 BSC	
M	0°	15°	0°	15°
N	0.020	0.040	0.51	1.01

**SO-20**  
**DW SUFFIX**  
 20 PIN PLASTIC SOIC PACKAGE  
 CASE 751D-05  
 ISSUE F

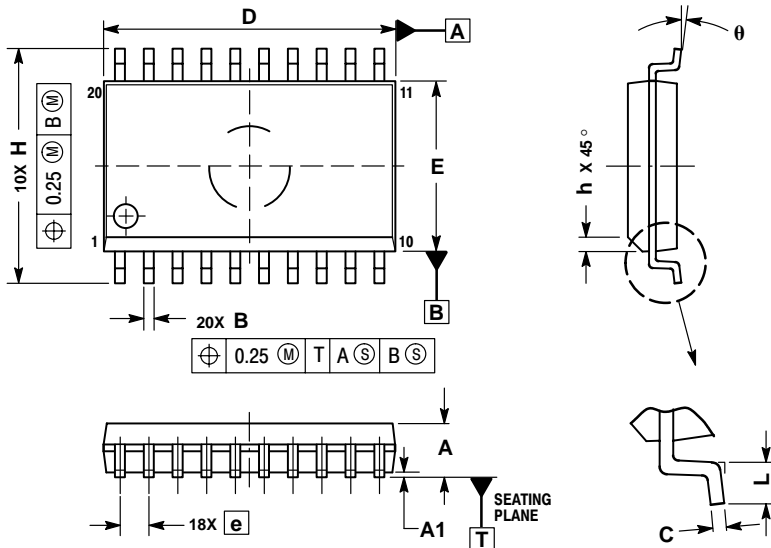

- NOTES:
1. DIMENSIONS ARE IN MILLIMETERS.
  2. INTERPRET DIMENSIONS AND TOLERANCES PER ASME Y14.5M, 1994.
  3. DIMENSIONS D AND E DO NOT INCLUDE MOLD PROTRUSION.
  4. MAXIMUM MOLD PROTRUSION 0.15 PER SIDE.
  5. DIMENSION B DOES NOT INCLUDE DAMBAR PROTRUSION. ALLOWABLE PROTRUSION SHALL BE 0.13 TOTAL IN EXCESS OF B DIMENSION AT MAXIMUM MATERIAL CONDITION.

DIM	MILLIMETERS	
	MIN	MAX
A	2.35	2.65
A1	0.10	0.25
B	0.35	0.49
C	0.23	0.32
D	12.65	12.95
E	7.40	7.60
e	1.27 BSC	
H	10.05	10.55
h	0.25	0.75
L	0.50	0.90
θ	0°	7°

# MC74AC377, MC74ACT377

## PACKAGE DIMENSIONS

**TSSOP-20**  
**DT SUFFIX**  
 20 PIN PLASTIC TSSOP PACKAGE  
 CASE 948E-02  
 ISSUE A

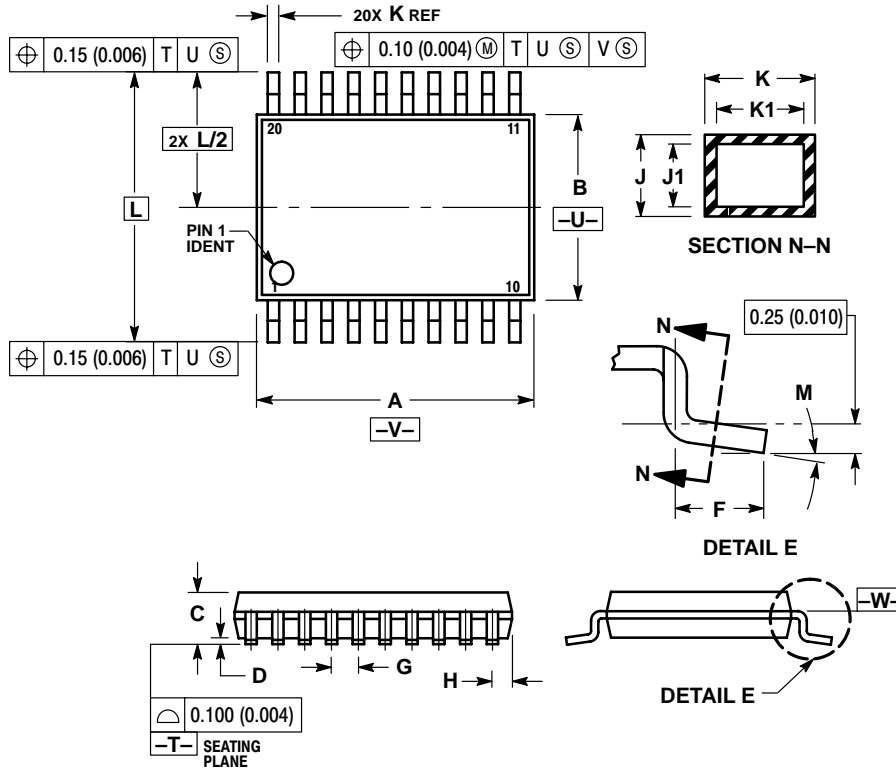

**NOTES:**

1. DIMENSIONING AND TOLERANCING PER ANSI Y14.5M, 1982.
2. CONTROLLING DIMENSION: MILLIMETER.
3. DIMENSION A DOES NOT INCLUDE MOLD FLASH, PROTRUSIONS OR GATE BURRS. MOLD FLASH OR GATE BURRS SHALL NOT EXCEED 0.15 (0.006) PER SIDE.
4. DIMENSION B DOES NOT INCLUDE INTERLEAD FLASH OR PROTRUSION. INTERLEAD FLASH OR PROTRUSION SHALL NOT EXCEED 0.25 (0.010) PER SIDE.
5. DIMENSION K DOES NOT INCLUDE DAMBAR PROTRUSION. ALLOWABLE DAMBAR PROTRUSION SHALL BE 0.08 (0.003) TOTAL IN EXCESS OF THE K DIMENSION AT MAXIMUM MATERIAL CONDITION.
6. TERMINAL NUMBERS ARE SHOWN FOR REFERENCE ONLY.
7. DIMENSION A AND B ARE TO BE DETERMINED AT DATUM PLANE -V-.

DIM	MILLIMETERS		INCHES	
	MIN	MAX	MIN	MAX
A	6.40	6.60	0.252	0.260
B	4.30	4.50	0.169	0.177
C	---	1.20	---	0.047
D	0.05	0.15	0.002	0.006
F	0.50	0.75	0.020	0.030
G	0.65 BSC		0.026 BSC	
H	0.27	0.37	0.011	0.015
J	0.09	0.20	0.004	0.008
J1	0.09	0.16	0.004	0.006
K	0.19	0.30	0.007	0.012
K1	0.19	0.25	0.007	0.010
L	6.40 BSC		0.252 BSC	
M	0° 8°		0° 8°	

**EIAJ-20**  
**M SUFFIX**  
 20 PIN PLASTIC EIAJ PACKAGE  
 CASE 967-01  
 ISSUE O

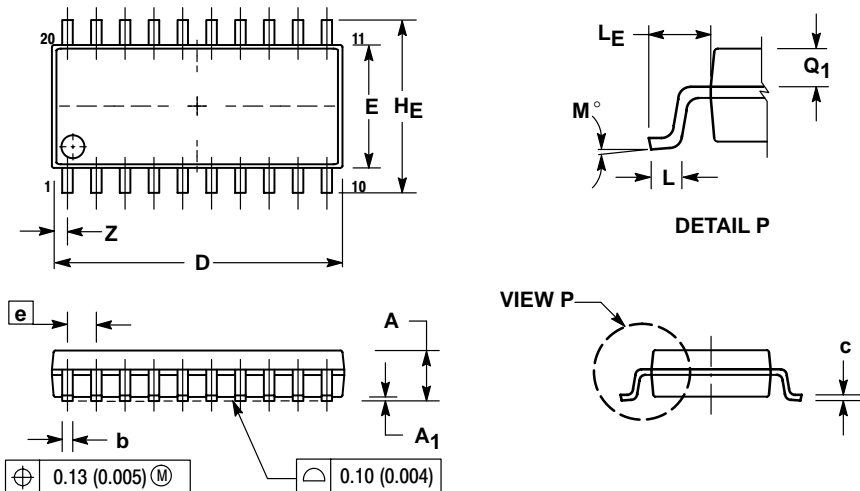

**NOTES:**

1. DIMENSIONING AND TOLERANCING PER ANSI Y14.5M, 1982.
2. CONTROLLING DIMENSION: MILLIMETER.
3. DIMENSIONS D AND E DO NOT INCLUDE MOLD FLASH OR PROTRUSIONS AND ARE MEASURED AT THE PARTING LINE. MOLD FLASH OR PROTRUSIONS SHALL NOT EXCEED 0.15 (0.006) PER SIDE.
4. TERMINAL NUMBERS ARE SHOWN FOR REFERENCE ONLY.
5. THE LEAD WIDTH DIMENSION (b) DOES NOT INCLUDE DAMBAR PROTRUSION. ALLOWABLE DAMBAR PROTRUSION SHALL BE 0.08 (0.003) TOTAL IN EXCESS OF THE LEAD WIDTH DIMENSION AT MAXIMUM MATERIAL CONDITION. DAMBAR CANNOT BE LOCATED ON THE LOWER RADIUS OR THE FOOT. MINIMUM SPACE BETWEEN PROTRUSIONS AND ADJACENT LEAD TO BE 0.46 (0.018).

DIM	MILLIMETERS		INCHES	
	MIN	MAX	MIN	MAX
A	---	2.05	---	0.081
A1	0.05	0.20	0.002	0.008
b	0.35	0.50	0.014	0.020
c	0.18	0.27	0.007	0.011
D	12.35	12.80	0.486	0.504
E	5.10	5.45	0.201	0.215
e	1.27 BSC		0.050 BSC	
HE	7.40	8.20	0.291	0.323
L	0.50	0.85	0.020	0.033
LE	1.10	1.50	0.043	0.059
M	0° 10°		0° 10°	
Q1	0.70	0.90	0.028	0.035
Z	---	0.81	---	0.032

**Notes**

**ON Semiconductor** and  are trademarks of Semiconductor Components Industries, LLC (SCILLC). SCILLC reserves the right to make changes without further notice to any products herein. SCILLC makes no warranty, representation or guarantee regarding the suitability of its products for any particular purpose, nor does SCILLC assume any liability arising out of the application or use of any product or circuit, and specifically disclaims any and all liability, including without limitation special, consequential or incidental damages. "Typical" parameters which may be provided in SCILLC data sheets and/or specifications can and do vary in different applications and actual performance may vary over time. All operating parameters, including "Typicals" must be validated for each customer application by customer's technical experts. SCILLC does not convey any license under its patent rights nor the rights of others. SCILLC products are not designed, intended, or authorized for use as components in systems intended for surgical implant into the body, or other applications intended to support or sustain life, or for any other application in which the failure of the SCILLC product could create a situation where personal injury or death may occur. Should Buyer purchase or use SCILLC products for any such unintended or unauthorized application, Buyer shall indemnify and hold SCILLC and its officers, employees, subsidiaries, affiliates, and distributors harmless against all claims, costs, damages, and expenses, and reasonable attorney fees arising out of, directly or indirectly, any claim of personal injury or death associated with such unintended or unauthorized use, even if such claim alleges that SCILLC was negligent regarding the design or manufacture of the part. SCILLC is an Equal Opportunity/Affirmative Action Employer.

## PUBLICATION ORDERING INFORMATION

### Literature Fulfillment:

Literature Distribution Center for ON Semiconductor  
P.O. Box 5163, Denver, Colorado 80217 USA  
**Phone:** 303-675-2175 or 800-344-3860 Toll Free USA/Canada  
**Fax:** 303-675-2176 or 800-344-3867 Toll Free USA/Canada  
**Email:** ONlit@hibbertco.com

**N. American Technical Support:** 800-282-9855 Toll Free USA/Canada

**JAPAN:** ON Semiconductor, Japan Customer Focus Center  
4-32-1 Nishi-Gotanda, Shinagawa-ku, Tokyo, Japan 141-0031  
**Phone:** 81-3-5740-2700  
**Email:** r14525@onsemi.com

**ON Semiconductor Website:** <http://onsemi.com>

For additional information, please contact your local Sales Representative.